

INTRODUCTION

CONTENTS

Tektronix products are grouped according to common characteristics on pages 2, 3, 4, 5. You can compare the performance of a group of instruments that share similar characteristics with your measurement requirements. For example, those oscilloscopes that feature portability; those oscilloscopes that use the same group of plug-in units; those oscilloscopes that use the sampling technique for their display; etc. Thorough study of these groupings will give you a better understanding of the Tektronix product line.

REFERENCE CHARTS

Since bandwidth, risetime, and deflection factor as well as other parameters are of vital interest to you in selecting an instrument, a reference chart is provided which outlines these essentials. Referring to this chart will allow you to make a quick comparison among instruments.

This reference chart is found on pages 6 to 8 and covers all Tektronix general purpose oscilloscopes. Listed are the different oscilloscopes (with plug-in units if used) available within a particular bandwidth range. The chart also lists the important features and characteristics of the oscilloscope, the price, and the catalog page number where you will find the instrument described in complete detail.

After you've narrowed your selection, turn to the page indicated by the chart for a complete description. You will notice that each major instrument description includes a characteristic summary that contains details of the vertical, horizontal, and CRT systems. Comparing the summaries of any two instruments will point out their major differences.

REFERENCE INFORMATION

Page 9 explains the significance of characteristics in terms of measurement capability. Much of the information on bandwidth and risetime will be helpful in judging the applicability of various instruments to a measurement problem. Page 10

discusses Tektronix-manufactured components and also contains a chart of available CRT phosphors with technical data as well as suggested areas of usage. Page 11 discusses Photographic Writing Speed considerations, a subject of particular interest to those concerned with photographing oscilloscope displays of non-recurring phenomenon.

FIELD OFFICE ASSISTANCE

Tektronix maintains 61 domestic and international field offices as well as 39 distributors spread throughout the world. These offices are staffed with qualified field engineers who specialize in solving measurement problems. They provide a direct communication link between you and the factory and are the people to contact for assistance. Please call or visit your nearest field office for details on applications, maintenance, instrument selection or instrument orders. You'll find these offices listed on pages 12 through 16.

Ordering information such as terms, shipment, and warranty are contained on pages 12 through 16.

ABBREVIATIONS AND GLOSSARY

Page 19 lists some of the abbreviations used at Tektronix, primarily derived from IEEE standards. The glossary on pages 20 to 22 represents our concept of the terms used in this catalog.

ACCESSORIES

Accessory items for use with Tektronix instruments are described on pages 296 through 335.

INDEX

The last two pages contain a comprehensive index of (1) instruments in numerical order according to type numbers, and (2) accessories by subject.

TEKTRONIX, INC.

An Oregon Corporation

Corporate Offices and Plant Located at:

TEKTRONIX INDUSTRIAL PARK

14150 S.W. KARL BRAUN DRIVE

BEAVERTON, OREGON

Mailing Address: P. O. Box 500, Beaverton, Oregon 97005

Telephone: (503) 644-0161

TWX: 503-291-6805

Telex: 036-636

Cable: TEKTRONIX



TEKTRONIX,
SCOPE-MOBILE
are registered trademarks
of Tektronix, Inc.

Information in this catalog supersedes all previously published material. Specification and price change privileges reserved.

© 1968 Tektronix, Inc. All Rights Reserved.



ITALY

DISTRIBUTOR **SILVERSTAR LTD.**

Cable : **SILVERSTAR MILANO**

Telex : 32634 SILSTAR

VIA DEI GRACCHI, 20

MILANO

20146

Tel. 46.96.551 / 5 lines

46.92.462

46.92.476

46.92.468

46.92.724

46.95.672

SILVERSTAR LTD.

Via Paisiello N30

ROMA 00198

Telephone : 855.366 - 869.009

Cable **SILVERSTAR - ROMA**

Telex : 61511 SILSTAR

SILVERSTAR LTD.

Via Castelfidardo N21

TORINO 10129

Telephone : 543.527 - 540.075

Cable **SILVERSTAR TORINO**

CATALOG No. 27

MID 1968 - MID 1969

TEKTRONIX LTD.

ALL PRICES IN ITALIAN LIRA

OSCILLOSCOPES

*310A	846.000
317	1.083.500
321A	1.104.500
360	343.000
410	961.500
+422	1.465.000
+422/125B	1.952.000
+422/146B	1.529.000
+453	1.998.000
453/127C	2.403.000
453/163D	2.376.000
453/165M	2.961.000
454	2.860.000
454/163D	3.122.000
454/165M	3.709.000
+502A	1.052.000
503	766.500
504	648.000
507	3.615.000
*515A	1.085.500
516	1.321.000
519	4.774.000
520 NTSC	2.153.000
520 PAL/188M	2.153.000
*524AD	1.591.000
528	929.500
528/188G	929.500
529	1.267.500
529/188D	1.456.000
*531A	1.243.000
*533A	1.388.000
+535A	1.468.000
536	1.358.500
543B	1.618.000
544	1.819.500
+545B	1.670.000
546	2.050.000
+547	1.832.000
+549	2.467.000
551	2.326.000
555	3.293.000
+556	3.480.000
+561A	498.000
+564	920.000
+564/08	920.000
565	1.743.500
567	890.500
568	1.030.500
575	1.184.000
575/122C	1.612.000
+581A	1.582.000
+585A	1.870.000
601	1.218.000
601/146B	1.190.000
611	2.904.000
647A	1.804.000
661	1.411.500
RM15	1.187.000
RM17	1.181.500

R422	1.749.000
R422/150B	3.367.000
R422/150E	1.749.000
R453	2.370.000
R453/127C	2.515.000
R453/163D	2.487.000
R454	3.118.000
R454/163D	3.235.000
RM502A	1.454.000
RM503	790.000
RM503/171A	922.000
RM504	665.500
RM504/171A	732.500
R520 NTSC	2.153.000
R520 PAL/188M	2.153.000
RM529	1.335.500
RM529/188D	1.525.000
RM31A	1.371.500
RM35A	1.775.000
RM543B	1.749.000
RM544	1.949.000
RM544/720A	4.197.000
RM545B	2.036.000
RM546	2.181.000
RM547	2.327.000
R556	3.926.000
RM561A	691.000
RM561A/171A	758.500
RM564	1.205.500
RM564/171A	1.267.000
RM564/08	1.205.500
RM564/171A/08	1.267.000
RM565	1.859.000
RM567	1.018.000
R568	1.088.000
RM585A	2.207.000
R647A	1.961.000

MEASUREMENT SYSTEMS

S3100	13.985.000
-------	------------

PLUG-IN UNITS

*B	193.500
+CA	288.000
*D	216.500
*E	233.000
*G	233.000
*H	227.500
*K	175.000
+L	241.000
+M	583.000
O	636.000
Q	395.000
T	290.500
W	634.500
Z	634.500
+81A	163.500
+82	727.000

ALL PRICES IN ITALIAN LIRA

86	433.500
-1A1	611.000
-1A2	365.000
-1A4	859.000
1A5	633.500
-1A6	262.000
1A7A	507.000
-IS1	1.258.000
IS2	1.588.000
2A60	128.500
2A61	462.000
2A61/156M	462.000
2A63	193.500
-2B67	210.000
-3A1	530.000
3A2	601.500
3A3	953.000
3A5	915.000
-3A6	521.000
3A7	763.000
3A8	724.000
3A72	344.500
-3A74	590.000
3A75	222.000
3B2	780.000
-3B3	624.000
3B4	495.000
3B5	1.066.000
3C66	495.000
3S1	1.330.000
3S2	925.000
S1	288.000
S2	347.500
3S3	1.814.000
3T2	1.144.000
3T4	1.590.000
3T77A	797.000
4S1	1.707.000
4S2A	1.727.000
4S3	1.727.000
5T3	981.000
6R1A	3.182.000
10A1	1.081.000
10A2A	930.000
11B1	780.000
11B2A	1.021.000

AUXILIARY INSTRUMENTS

106	730.500
106/146B	702.000
109	443.500
111	453.000
113	329.000
114	364.000
114/146B	334.500
R116	1.927.000
122	170.500
FM122	176.000

RM122	177.000
125	352.000
FM125	356.500
RM125	359.500
127	839.500
129	816.000
130	277.000
132	565.500
133	543.500
160A	259.500
161	170.500
162	170.500
163	170.500
175	1.860.000
175/167C	1.860.000
184	813.000
184/146B	785.500
191	500.000
191/146B	467.500
230	3.434.000
R230	3.491.000
262	1.870.000
263	379.500
283	434.500
R283	435.500
284	610.000
284/146B	583.000
292	396.000
R293	1.221.000
1121	575.500

SPECTRUM ANALYSERS

1L5	1.155.000
1L10	1.327.500
1L20	2.216.500
1L30	2.216.500
3L5	1.265.000
3L10	1.455.500
491	5.078.000
R491	5.207.000

ACCESSORIES AND CAMERAS

200-1	98.000
200-2	98.000
+201-1	134.000
+201-2	144.000
+202-1	134.000
202-1 Mod. 52	213.500
+202-2	144.000
205-1	174.000
205-2	187.000
205-3	187.000
C-12	538.000
C-27	498.000
C-30	484.000
C-31R	636.000
C-40	649.000

ATTACH TO INSIDE OF FRONT COVER OF YOUR CATALOG AND FOLD BACK TO USE

**FOR PRICE DETAILS OF PARTS
AND ACCESSORIES SHOWN IN THE REAR
OF THE CATALOG —
PLEASE CONSULT YOUR DISTRIBUTOR**



NEW PRODUCTS

Supplement To Your Tektronix Catalog 27

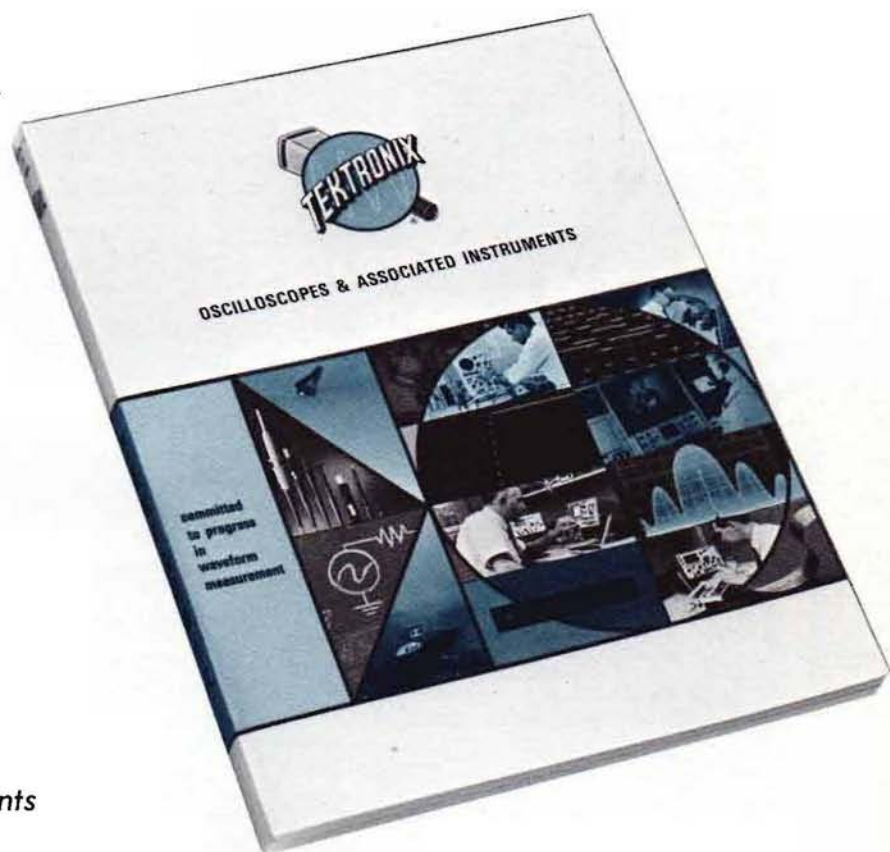

24 NEW Instruments

NEW Measurement Systems

Note: for complete catalog information,
attach this supplement to your 1968 Tektronix Catalog.
See back flap for instructions

CONTENTS

INSTRUMENT	PAGE
323 Portable Oscilloscope	1
528 Television Waveform Monitor	3
Engine Analyzer	8
602 5-Inch Display Unit	12
S-3 350-ps Sampling Head	15
S-4 25-ps Sampling Head	16
S-50 25-ps Pulse Generator Head	16
S-51 1-to-18 GHz Trigger Countdown Head	17
285 Power Supply	17
115 Pulse Generator	18
1L40 1.5-to-40 GHz Spectrum Analyzer Unit	20
Swept-Frequency Converter for Spectrum Analyzers	21
C-30A Trace-Recording Camera	22
C-31 Trace-Recording Camera	23
P6048 DC-to-140 MHz 10X Voltage Probe	25
P6049 DC-to-21 MHz 10X Voltage Probe	25
DIGITAL INSTRUMENT INTRODUCTION	26
3S5 Programmable Sampling Unit	28
3S6 Programmable Sampling Unit	29
3T5 Programmable Sampling Sweep Unit	30
3T6 Programmable Sampling Sweep Unit	31
241 Programmer	32
240 Program Control Unit	36
R250 Auxiliary Program Unit	40
S-3110 Digital Measurement System	34
S-3130 Digital Measurement System	44



TYPE 323 DC-to-4 MHz PORTABLE OSCILLOSCOPE

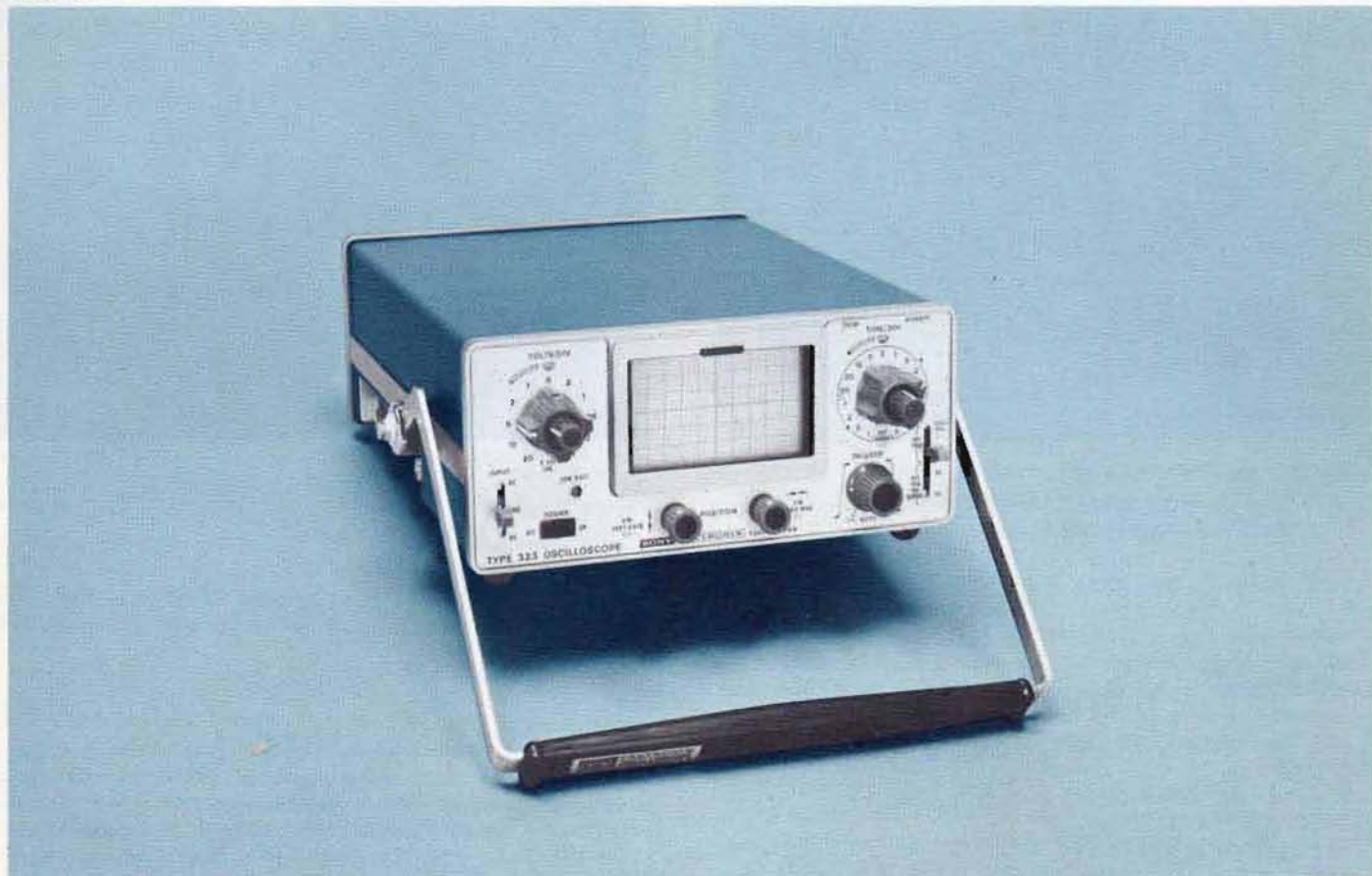

- AC, DC OR BATTERY POWERED
- COMPACT SIZE—WEIGHT \approx 7 lb
- ALL SOLID-STATE RELIABILITY
- 4-MHz BANDWIDTH AT 10 mV/DIV
- LOW POWER CONSUMPTION
- DESIGNED FOR SEVERE ENVIRONMENTS

The Type 323 is an all solid-state, single-channel, 4-MHz portable oscilloscope providing the operator the convenience of using AC, DC or internal rechargeable batteries for powering the instrument. The 323 features small size and weight, together with extremely low power consumption. Depth is $10\frac{5}{8}$ inches, width— $8\frac{1}{2}$ inches, height— $4\frac{1}{4}$ inches, weight— \approx 7 pounds. Power consumption is up to 4.5 watts, typically 1.6 watts from an external DC source and 14 watts when powered from the AC line. Internal rechargeable batteries will provide up to 8 hours continuous operation, sufficient for a full working day. The portability/performance provided by the Type 323 Oscilloscope, makes it most attractive for use in "on-site" maintenance applications; for example, industrial control equipment, communication systems, business machines and computers.

CHARACTERISTIC SUMMARY

VERTICAL

BANDWIDTH—DC to 4 MHz.

RISETIME—90 ns.

CALIBRATED DEFLECTION FACTOR—10 mV/div to 20 V/div at full bandwidth, 1 mV/div at 2.75-MHz bandwidth.

INPUT RC—1 megohm paralleled by approx 47 pF.

HORIZONTAL

CALIBRATED TIME BASE— $5\ \mu$ s/div to 1 s/div.

X10 MAGNIFIER—Extends time base to $0.5\ \mu$ s/div.

EXTERNAL INPUT—30 mV/div to 20 V/div, continuously variable, DC to 10 kHz.

CRT

DISPLAY AREA— 6×10 divisions ($\frac{1}{4}$ inch/division).

PHOSPHOR—P31.

OTHER

AMPLITUDE CALIBRATOR—Internal, 0.5 V at external jack.

POWER SOURCES—Internal batteries; external DC supply of 6 to 16 V, 4.5 W; 90 to 136 VAC or 180 to 272 VAC, 48 Hz to 440 Hz, 14 W at 115 VAC.

TYPE 323



EASY TO CARRY

Adjustable handle and included shoulder strap make this 7-pound oscilloscope easy to carry.

VERTICAL DEFLECTION

BANDWIDTH

DC to at least 4 MHz at 3-dB down. DC to at least 2.75 MHz at 3-dB down using X10 gain. Low-frequency 3-dB-down point with AC coupling is 2 Hz or less, extending to 0.2 Hz or less with the included 10X probe.

RISETIME

90 ns or less; 130 ns or less using X10 gain.

DEFLECTION FACTOR

10 mV/div to 20 V/div in 11 calibrated steps (1-2-5 sequence), 1 mV/div to 2 V/div using X10 gain, all steps accurate within 3%. Uncalibrated, continuously variable between steps and to approx 50 V/div.

INPUT RC

1 megohm within 2% paralleled by 47 pF within 4 pF.

MAXIMUM INPUT VOLTAGE

500 V combined DC + peak AC.

DISPLAYED NOISE

0.1 div or less at 1 mV/div, using included probe or 50- Ω termination.



Input and output connections are provided on the left side panel, freeing important front panel space for operating controls.

HORIZONTAL DEFLECTION

TIME BASE

5 μ s/div to 1 s/div in 17 calibrated steps (1-2-5 sequence), accurate within 3% from 5 μ s/div to 0.2 s/div, accurate within 4% from 0.5 s/div to 1 s/div. Uncalibrated, continuously variable between steps and to approx 2.5 s/div.

X10 MAGNIFIER

Operates over full time base, increases fastest sweep rate to 0.5 μ s/div. Accuracy of magnified display is within 5% from 2 μ s/div to 20 ms/div, within 6% at 0.5 μ s/div, 1 μ s/div, 50 ms/div, and 0.1 s/div.

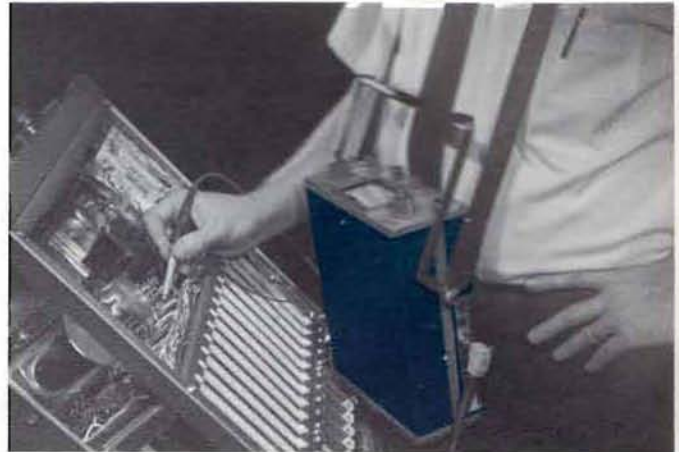

EASY TO USE

Small size of the Type 323 makes it easy to carry around the neck or support in the lap.

EXTERNAL INPUT

Continuously variable from approx 25 mV/div to approx 25 V/div, AC or DC coupled. DC to at least 10 kHz at 3-dB down.

TRIGGER

MODES

Automatic or manual level selection with a single control. Automatic operation is useful above 30 Hz, minimizes trigger adjustment for non-composite signals of different amplitudes, and repetition rates. With no input, automatic triggering provides a bright baseline at all sweep rates.

COUPLING

AC and AC LF REJ for internal triggering, AC and DC for external triggering. 300-V maximum input voltage (combined DC + peak AC).

AMPLITUDE REQUIREMENTS

0.3-div deflection or 75 mV external to 400 kHz, increasing to 0.75-div deflection or 190 mV external at 4 MHz. Requirements increase below 30 Hz with internal or external AC coupling and below 30 kHz with AC LF REJ coupling.

CRT

CRT

6 x 10-div display area; each div is 1/4 inch. CRT uses direct heated cathode, providing a useful display approx two seconds after turn-on. P31 phosphor normally supplied. External blanking input requires +5 V to +20 V (DC coupled), is usable from DC to at least 100 kHz. 150-V maximum input voltage (combined DC + peak AC).

GRATICULE

Internal, non-illuminated. Vertical and horizontal centerlines marked in 5 minor divisions per major 1/4-inch division.

ENVIRONMENTAL CAPABILITIES

AMBIENT TEMPERATURE

Operating: -15°C to +55°C.

Non-operating: -55°C to +75°C (without batteries).

-40°C to +60°C (with batteries).

ALTITUDE

Operating: 15,000 feet; maximum ambient temperature rating must be decreased by 1°C/1000 feet from 5,000 feet to 15,000 feet.

Non-operating: 50,000 feet.

VIBRATION

Operating: 15 minutes along each of the 3 major axes, 0.025 inch peak-to-peak displacement (4 g's at 55 c/s) 10 to 55 to 10 c/s in 1-minute cycles.

SHOCK

Operating and non-operating: 30 g's, 1/2 sine, 11-ms duration, 2 shocks per axis in each direction for a total of 12 shocks.

ELECTROMAGNETIC INTERFERENCE

Meets radiated interference requirements of MIL-I-6181D and MIL-I-1690C over the range 150 kHz to 1 GHz. Instrument must be battery operated with CRT mesh filter (378-0596-00) installed. Installation of the CRT mesh filter enhances the display contrast; however, it excludes the use of the internal non-illuminated graticule.

HUMIDITY

Non-operating: Meets electrical performance specifications after exposure to five cycles (120 hours) of Mil-Std-202C. Method 106B (omit freezing and vibration, and allow a post-test drying period at +25°C ±5°C at 20% to 80% relative humidity).

OTHER CHARACTERISTICS

AMPLITUDE CALIBRATOR

0.5V at external jack, accurate within 1% from +20°C to +30°C, within 2% throughout the operating temperature range. Output resistance approx 10 kΩ. Risetime 2 μs or less; duty cycle 40% to 60%. Output also applied internally to vertical amplifier.

PROBE

The P6049 is a miniaturized 10X probe with 3.5-foot cable, and right-angle BNC connector. Input RC with probe is 10 MΩ within 2% paralleled by less than 13.5 pF.

POWER SOURCES

Battery operation: removeable power pack contains 6 size "C" NiCd cells providing 3.4 to 8 hours operation. Operating time depends on signal conditions, the setting of trace intensity, operating temperature and temperature during previous battery charge. Maximum time is achieved at 20°C to 25°C charge and 20°C to 30°C operating temperature. Internal charger provides two charging rates for the internal batteries when connected to the AC line. Recharge requires at least 16 hours at FULL CHARGE, or at least 64 hours at TRICKLE CHARGE.

External DC source: operates from an external DC source of 6 V to 16 V, requires up to 4.5 W, typically 1.6 W.

External AC source: operates from an external AC source of 90 to 136 V, or 180 to 272 V. 48 to 440 Hz, 14 W maximum at 115 VAC.

DIMENSIONS AND WEIGHTS

Height	4 1/4 in	10.8 cm
Width without handle	7 1/4 in	18.4 cm
Width with handle	8 1/2 in	21.6 cm
Depth with panel cover	10 5/8 in	27.0 cm
Depth with handle extended	12 3/4 in	32.3 cm
Net weight without accessories	≈ 7 lb	≈ 3.2 kg
Domestic shipping weight	≈ 13 lb	≈ 5.9 kg
Export-packed weight	≈ 21 lb	≈ 9.5 kg

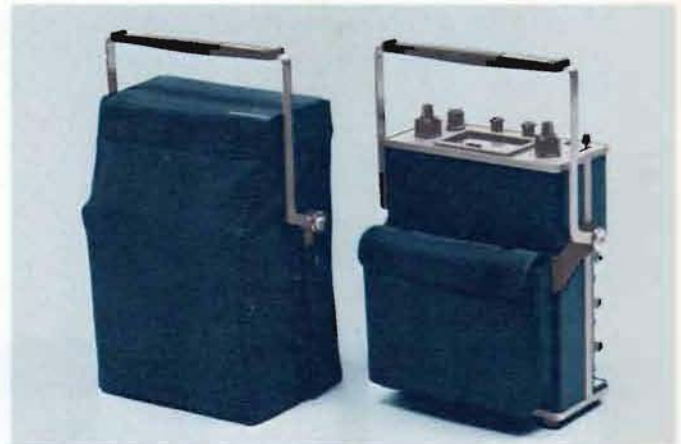

Optional rain jacket (left) slips over the Type 323 and its included accessory pouch (right).

INCLUDED STANDARD ACCESSORIES

P6049 10X probe (010-0223-00); patch cord (012-0089-00); accessory pouch (016-0113-00); viewing hood (016-0247-01); 3 to 2-wire adapter (103-0013-00); BNC-to-binding post adapter (103-0033-00); power cord (161-0043-00); panel cover (200-0812-00); strap assembly (346-0051-00); light filter (426-0403-00); two instruction manuals (070-0750-00).

The SONY®/TEKTRONIX® Type 323 is manufactured and marketed in Japan by Sony/Tektronix Corporation, Tokyo, Japan. Outside of Japan the Type 323 is available from Tektronix, Inc., its marketing subsidiaries and distributors.

OPTIONAL ACCESSORIES

RAIN JACKET

The rain jacket provides protection for the Type 323 during transport or storage, is constructed of waterproof blue vinyl, order 016-0112-00

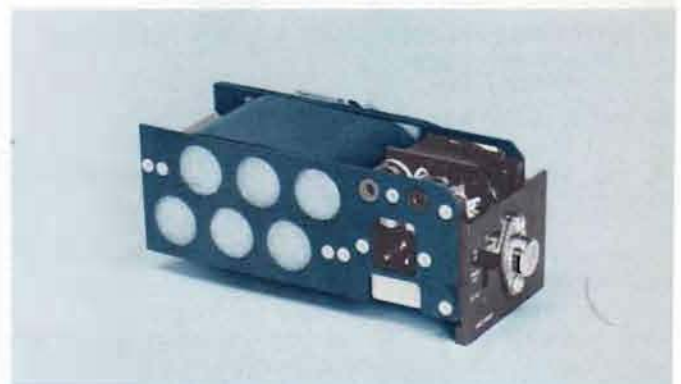

POWER PACK

Extra power pack, in addition to the one supplied with the Type 323 allows one power pack to charge while the other is powering the oscilloscope. Pack contains 6 size "C" NiCd cells and battery charger, order 016-0119-00

BATTERY SET

Set of 6 NiCd cells, order 146-0012-00



TYPE 528 TELEVISION WAVEFORM MONITOR



- **LARGE 8 x 10 cm DISPLAY AREA**
- **1/2 RACK SIZE**
- **TWO VIDEO INPUTS**
- **PICTURE MONITOR OUTPUT**
- **SELECTABLE 1-VOLT AND 4-VOLT FULL SCALE DEFLECTION FACTORS**
- **YRGB AND RGB INPUTS**
- **ALL SOLID-STATE—LOW POWER CONSUMPTION**

The solid-state Type 528 Television Waveform Monitor provides bright, easy-to-read video waveform displays on a 5-inch CRT, yet requires only 5-1/4-inch vertical height and 1/2-rack width mounting space. This compact instrument is especially well suited for monitoring signals from camera outputs, video system output lines, transmitter video input lines, closed-circuit TV systems and educational TV systems.

Either of two video inputs, selectable from the front panel, may be displayed. The displayed video signal is also provided at a video output jack for viewing on a picture monitor. Calibrated, 1-volt and 4-volt full scale (140 IRE unit) sensitivities are provided for displaying common video and sync signal levels. A variable sensitivity control permits uncalibrated displays from 0.25-volt to 4.0-volt full scale. The built-in 1-volt calibration signal may be switched on to check vertical sensitivity calibration. Flat, IRE, Chroma, and Diff Gain frequency response positions permit observation of various signal characteristics.

Horizontal Sweep selection provides 2H (two line), 1 μ s/div (expanded two line), 2V (two field) and 2V MAG (expanded two field). Displays of RGB and YRGB waveforms from color processing amplifiers are provided for with interconnection through a rear-panel 9-pin receptacle.

A DC Restorer maintains the back porch at an essentially constant level despite changes in signal amplitude, APL and color burst. May be turned off when not needed.

All solid-state circuitry provides low power consumption, and long-term reliability.

VIDEO FEATURES

INPUTS

Rear-panel BNC connectors provide two unbalanced inputs (A & B) which may be used with either 75- Ω loop-through or bridging connection. Maximum return loss for A and B video inputs, terminated in 75 Ω , operating or non-operating is 40 dB or greater from 25 Hz to 5 MHz. Normally AC coupled but may be easily modified by user for DC coupling.

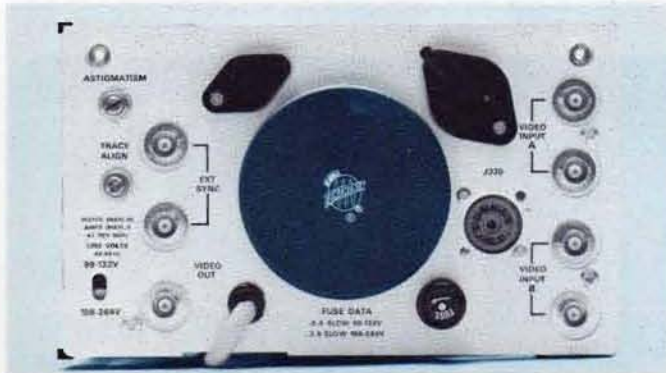

Rear panel of Type 528 Waveform Monitor.

DEFLECTION FACTOR

Calibrated 1-volt and 4-volt (for 140 IRE unit deflection) positions are provided for video inputs A or B with accuracy within 1% for the 1-volt positions and 3% for the 4-volt positions. A variable sensitivity control permits uncalibrated displays from 0.25-volt to 4.0-volt full scale.

FREQUENCY RESPONSE

4 response positions are provided: FLAT—25 Hz to 3.6 MHz within 1% of response at 50 kHz, 3.6 MHz to 5 MHz +1%, -3% of response at 50 kHz, and +1%, -3% of response at 3.58 MHz; IRE—per 1958 IRE STD 23S-1 (amended). Response at 4.43 MHz attenuated at least 22 dB; CHROMA—30% down between 3.1 MHz and 3.4 MHz, 30% down between 3.8 MHz and 4.1 MHz. Response at 3.58 MHz does not vary between FLAT and CHROMA by more than 1%. DIFF GAIN—same as CHROMA response with additional gain for displaying 100 IRE units of 90 mV to 143 mV subcarrier levels.

DIFFERENTIAL GAIN

1% or less with 10 to 90% APL changes using DIFF GAIN operating mode with modulated staircase signal, baseline adjusted to 50 IRE units position, and signal adjusted to 100 IRE units P-P.

TRANSIENT RESPONSE

1-volt or 4-volt calibrated deflection factor, FLAT response position, using 125-ns HAD \sin^2 pulse and bar test signal: preshoot is not more than 1 IRE unit, overshoot not more than 2 IRE units, ringing not more than 2 IRE units and pulse to bar ratio within 0.99:1 to 1.01:1.

LOW FREQUENCY TILT

1% or less tilt on the vertical window or 60 Hz square wave (DC Restorer off).

MAXIMUM INPUT LEVEL

MAXIMUM DC INPUT

5 volts \ddagger for all response positions using AC coupling.

MAXIMUM AC INPUT

Flat and IRE response—Signal levels should be limited to produce displays not exceeding 200 IRE units.

CHROMA response—Chroma levels up to 140 IRE units may be displayed, provided the chroma plus luminance level does not exceed 200 IRE units when viewed in the FLAT response mode.

DIFF GAIN—Subcarrier signal levels of 90 mV to 143 mV peak to peak may be expanded, using the variable gain control, to 100 IRE units for measurement of differential gain with 10 to 90% APL.

DC RESTORER

Slow acting back porch DC restoration. Blanking level shift due to presence or absence of burst or changes in APL from 10% to 90% will not exceed 2 IRE units. May be disabled when desired.

VIDEO OUTPUT

The displayed signal is provided at a rear-panel BNC connector. Frequency response is 25 Hz to 5 MHz within 3%. Output signal amplitude is 1 volt within 15% for 140 IRE unit display using the FLAT response mode. DC level is 2 volt \ddagger or less into 75- Ω load. Nominal output impedance is 75 Ω . Return loss is 30 dB \dagger or greater from 25 Hz to 5 MHz.



Infrequently used operating controls are conveniently located behind a front-panel hinged door.

\dagger Exceeds CCIR recommendation 451-2 paragraph 3.1.

\ddagger Exceeds CCIR recommendation 451-2 paragraph 3.2.

TYPE 528

TIME BASE FEATURES

SYNCHRONIZATION

Internal or external sync is provided and is selectable by a switch behind the front panel hinged door. Internal sync is derived from composite video input. External sync is via a rear panel BNC loop-through connector and requires 1.5-volts to 4.5-volts composite sync input. The unterminated sync input impedance is approximately 15 k Ω paralleled by approximately 5 pF and maximum input voltage is 20 volts.‡

SWEEP MODES

4 sweep modes are provided: 2 V SWEEP—repetition rate equal to frame rate of applied video or external sync; 2 V MAG SWEEP—expands the vertical blanking interval (approximately 20X magnification of 2 V); 2 H SWEEP—repetition rate equal to half-line rate of applied video or external sync; 1 μ s/div SWEEP—calibrated sweep with accuracy within 3% for center 10 div of 12-div sweep, and linearity within 3% throughout horizontal POSITION range, excluding first and last div.

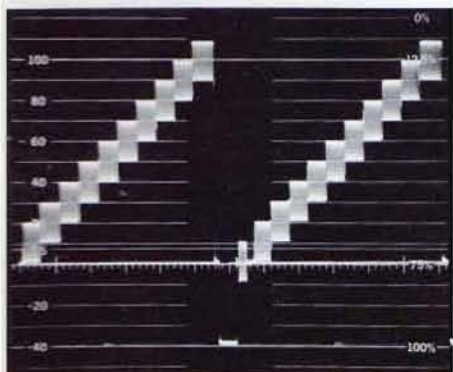

Fig 1. Modulated stairstep signal. 2 H SWEEP, FLAT response.

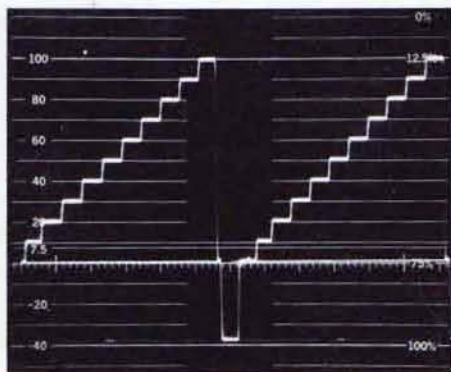

Fig 2. Modulated stairstep signal. 2 H SWEEP, IRE response.

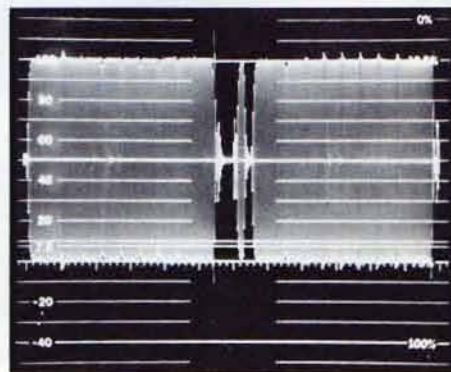

Fig 3. Modulated stairstep signal. 2 H SWEEP, DIFF GAIN response.

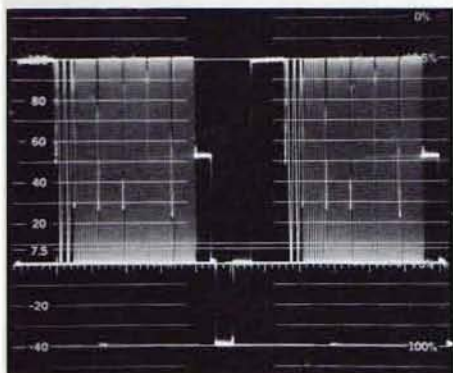

Fig 4. Multiburst signal. 2 H SWEEP, FLAT response.

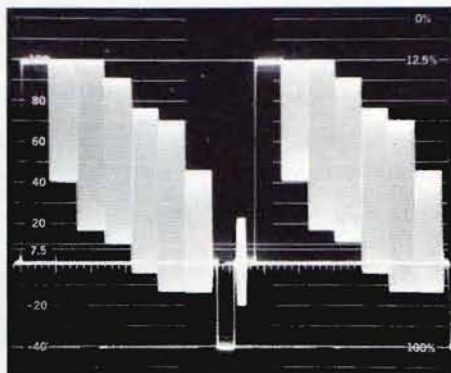

Fig 5. 75% saturated color bar signal. 2 H SWEEP, FLAT response.

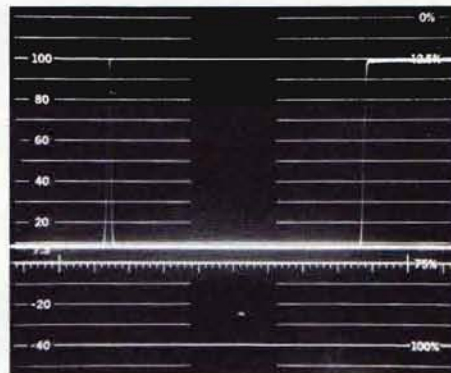

Fig 6. .125 μ s HAD Sin² Pulse and Bar. 1 μ s/div calibrated sweep, FLAT response.

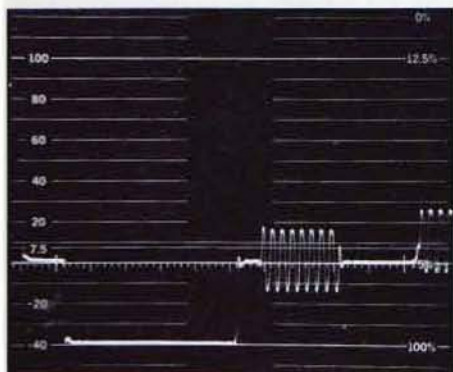

Fig 7. Horizontal Blanking Interval. 1 μ s/div calibrated sweep.

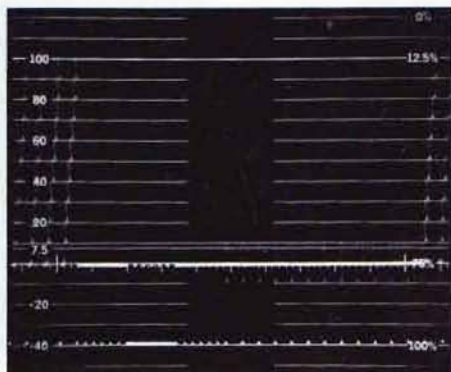

Fig 8. Vertical Blanking Interval. 2 V MAG SWEEP. 20X magnification permits convenient vertical blanking interval observation.

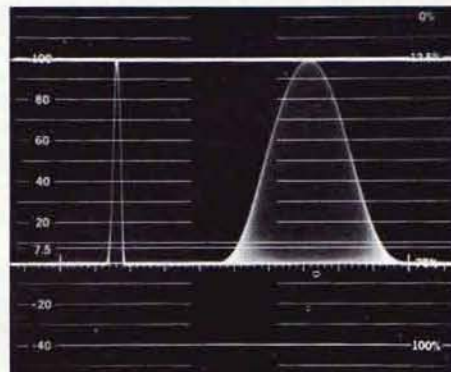

Fig 9. .250 μ s HAD Sin² Pulse (left) and Modulated 20 T Sin² Pulse (right) with superimposed Bar Signal (top).

YRGB AND RGB DISPLAYS

The Type 528 can be used with color camera processing amplifiers which provide the necessary sequential signal switching and staircase signals. A rear panel 9-pin receptacle provides the necessary interconnections. Factory wired for RGB (3 step) input.

STAIRSTEP AMPLITUDE

A 10-volt amplitude stairstep signal will produce a 9-div display length within 15%.

STAIRSTEP DC LEVEL

Peak AC plus DC signal levels shall not exceed limits of -12 to +12 volts. Maximum AC signal level is 12-volts peak-to-peak.

CONTROL SIGNALS

The RGB or YRGB modes may be initiated through the use of external voltage (12 volts to 15 volts) or ground connection at the rear panel 9-pin receptacle. A 9-pin plug is supplied with the included standard accessories.

OTHER FEATURES

REGULATED POWER SUPPLY

Operates on 99 volts AC to 132 volts AC and 198 volts AC to 264 volts AC, 48 Hz to 66 Hz line frequency. Operates on 115 volts $\pm 10\%$ or 230 volts $\pm 10\%$ at line frequencies from 66 Hz to 440 Hz. POWER CONSUMPTION: approx 48 watts at 115 volts AC, 60 Hz.

TEKTRONIX CATHODE-RAY TUBE

Flat-faced 5-inch rectangular CRT providing an 8x10 cm display area. P-31 phosphor normally supplied. External graticule with variable illumination.

CALIBRATOR

An internal calibration signal provides a convenient reference for verifying deflection factor. Amplitude is 1.0 volt within 1%.

DIMENSIONS AND WEIGHTS

Type 528: Height	5 $\frac{1}{4}$ in	13.3 cm
Width	8 $\frac{1}{2}$ in	21.6 cm
Depth	18 $\frac{1}{2}$ in	47.0 cm
Net weight	15 lb	6.8 kg

INCLUDED STANDARD ACCESSORIES

9-pin connector (136-0099-00), connector cover (200-0249-00), two instruction manuals (070-0800-00).

ORDERING INFORMATION

ORDER TYPE 528 FOR 525-LINE, 30-FRAME TELEVISION STANDARDS

ORDER TYPE 528 MOD 188G FOR 625-LINE, 25-FRAME TELEVISION STANDARDS, CALIBRATED WITH CCIR SIGNALS WITH CHROMA RESPONSE CENTERED AT 4.43 MHz.

OPTIONAL ACCESSORIES

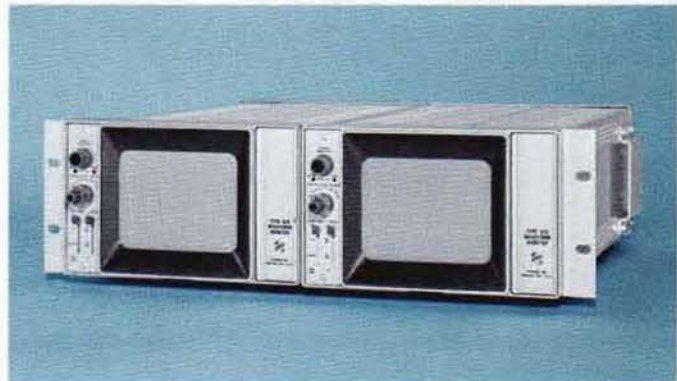

RACK ADAPTER

For mounting two Type 528's side-by-side in a standard 19-inch rack, order 016-0115-00

PANEL ASSEMBLY

For covering $\frac{1}{2}$ of rack adapter when only one Type 528 is rackmounted, order 016-0116-00



CABINET

Provides protection for the Type 528 when used for application out of the rack. Aluminum construction, blue vinyl finish, order 390-0018-00

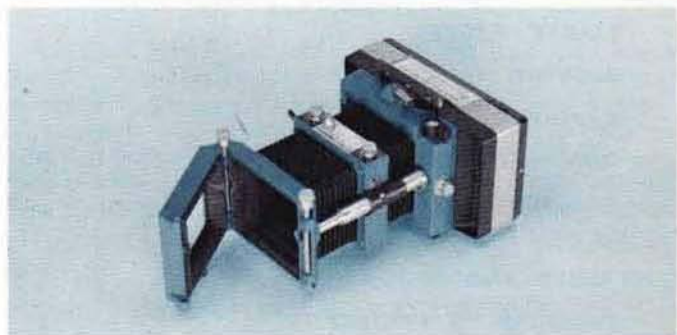

C-30A CAMERA

f/1.9 lens, magnification variable from 1.5:1 to 0.7:1; Polaroid Land* Pack-Film Back, order C-30A-P

Type 528 to C-30A camera adapter, 016-0248-00

*Registered Trademark Polaroid Corporation



ENGINE ANALYZER

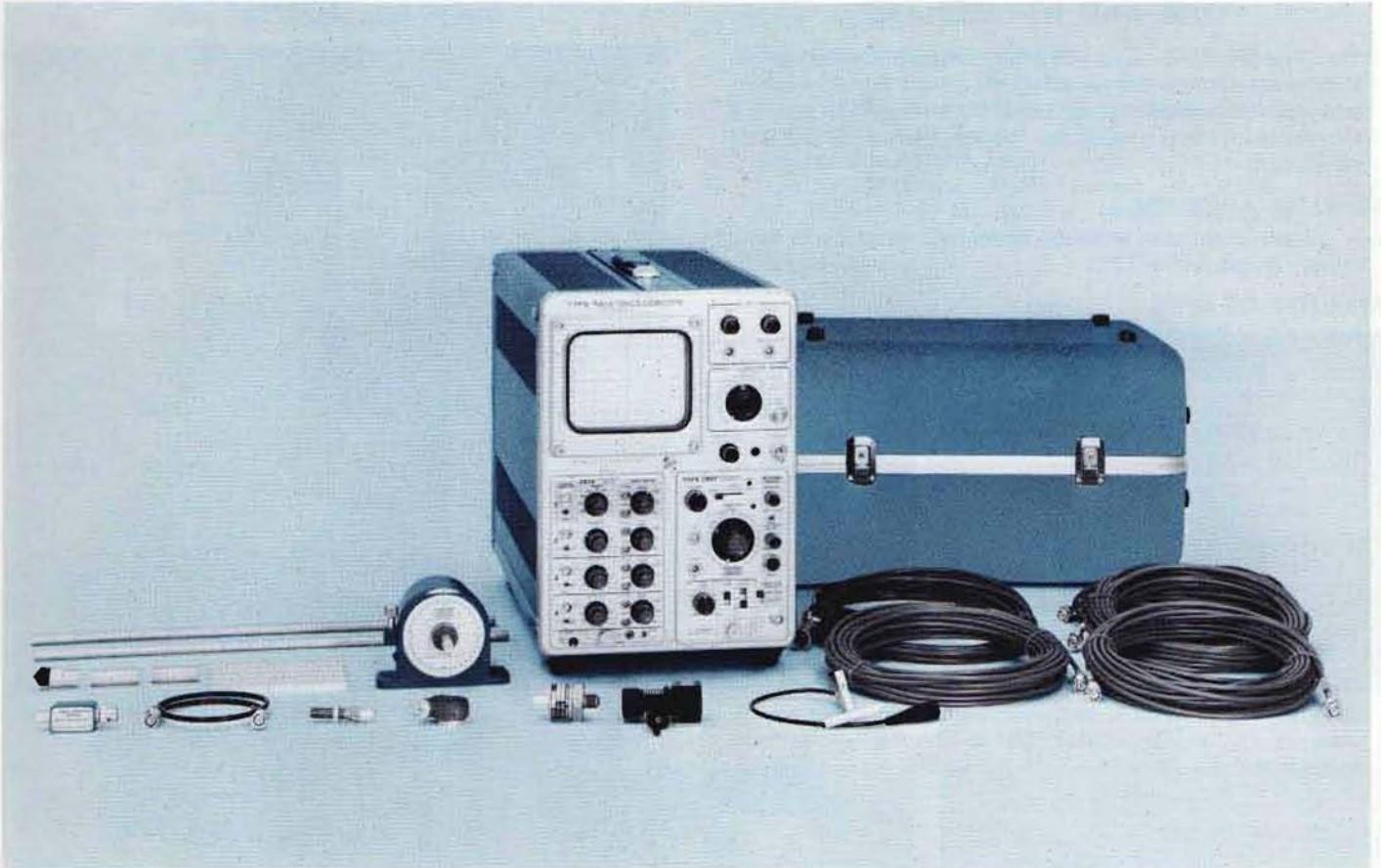

- **ELIMINATES GUESSWORK**
- **REDUCES MAINTENANCE COSTS**
- **DETECTS MALFUNCTIONS**
 - FAULTY IGNITION**
 - FAULTY VALVES**
 - BLOWBY**
 - DAMAGED RINGS**
 - DAMAGED BEARINGS**
 - DAMAGED CYLINDER LININGS**
- **MEASURE AND DISPLAY**
 - PRESSURE VS VOLUME**
 - PRESSURE VS CRANK ANGLE**
 - PRESSURE VS TIME**
 - ENGINE VIBRATION**
 - ENGINE IGNITION**
- **CRANK-ANGLE MARKERS**

The Tektronix Engine Analyzer is designed to eliminate guesswork in locating possible failures in gas and diesel engines and compressors. The over-all performance of the engine can be determined by measuring engine parameters such as cylinder combustion pressure, vibration, ignition, timing and indicated horsepower. When used in conjunction with a preventive maintenance program, the Engine Analyzer can substantially reduce maintenance costs and increase engine and compressor life and efficiency.

The Engine Analyzer detects and locates malfunctions such as faulty ignition, timing, faulty valves, blowby, and broken or frozen piston rings. Damaged bearings, low compression pressures and other failures that impair the performance of the engine are also indicated on the oscilloscope. With the use of the Rotational Function Generator and pressure transducer, the engine horsepower can be calculated.

The Tektronix Engine Analyzer consists of a Type 561A Oscilloscope or Type 564 Storage Oscilloscope, a specially designed Type 2B67 Engine Analyzer Time Base with a Rotational Function Generator input, and a Type 3A74 Engine Analyzer Amplifier featuring four channels, with separate inputs for pressure, ignition, vibration, and crank-shaft rotation markers.

The Engine Analyzer Accessories package includes a Rotational Function Generator, pressure transducers, vibration transducers, ignition pickoff, magnetic pickup, cables and an accessory carrying case. Optional accessories include a Polaroid* Trace-Recording Camera, Scope-Mobile® Cart and a tripod for easy mounting of the Rotational Function Generator.

*Registered Trademark, Polaroid Corporation

VIBRATION MEASUREMENTS

Vibration measurements are useful in detecting leaking valves, destructive detonation, excessive cylinder wear, blowby, worn bearings, broken compression rings, valve flutter and many other signs of wear and malfunction. The vibration pickup is a piezoelectric crystal mounted in a magnetic head that can be placed anywhere on the engine or compressor.

IGNITION MEASUREMENTS

Ignition measurements are used for proper timing of the engine and can detect bad spark plugs, pulse generator problems, point problems, bad condensers and coil condition. Ignition measurements can also be used to calculate RPM. Ignition measurements are made using a 1000X capacitive attenuator that clamps on the secondary coil and spark-plug wire.

PRESSURE MEASUREMENTS

Pressure measurements detect peak firing pressures, compression, early and late cylinder firing, and pre-ignition of the engine under test. Three displays of cylinder pressure are easily and quickly obtained: pressure vs crank angle, pressure vs cylinder volume and pressure vs time.

FOUR SIMULTANEOUS DISPLAYS

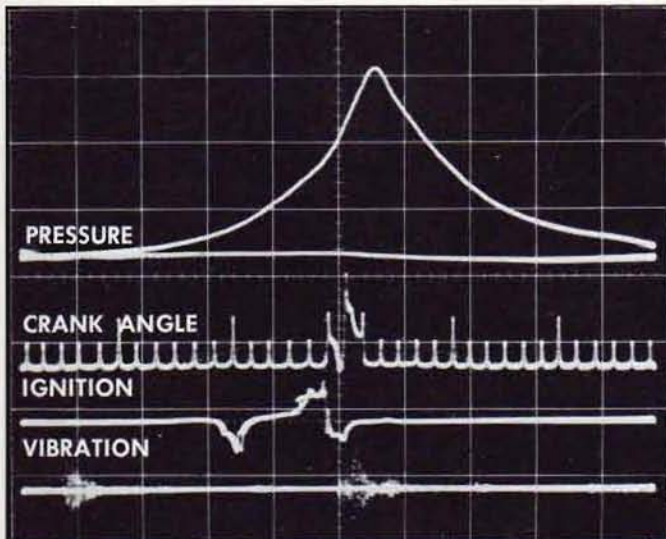

Simultaneous displays of four engine parameters provide the operator with one comprehensive picture of the total engine performance and make identification of malfunctions easy. The top waveform is engine pressure; waveform 2 shows crank-angle markers with the larger marker in the center indicating the top dead center; waveform 3 is engine ignition; waveform 4 is engine vibration showing valves opening and closing and vibration due to combustion.

PRESSURE VS VOLUME

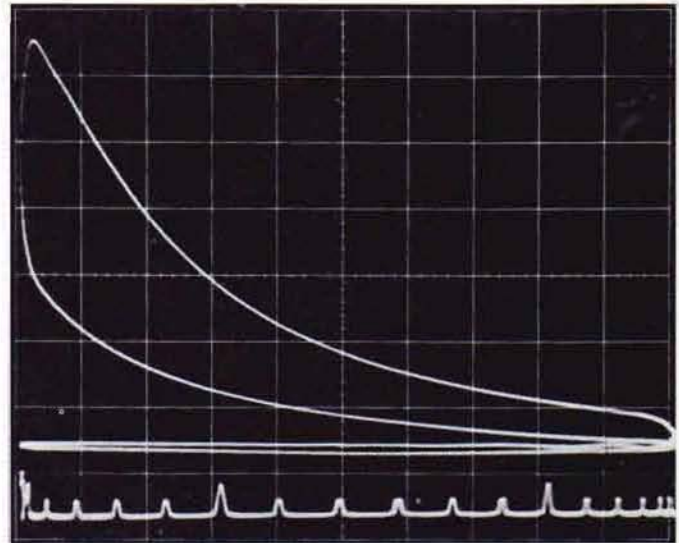

Pressure vs cylinder volume displays are used to determine the indicated engine horsepower and detect over-all problems in engines and compressors. The area within the loop is the mean effective pressure and is used to determine indicated horsepower of the engine.

$$hp = \frac{PLAN}{33,000}$$

hp = Horsepower

P = Mean Effective Pressure

L = Piston Stroke (ft)

A = Piston Area (in²)

N = Engine RPM

ENGINE ANALYZER CHARACTERISTICS

TYPE 561A OSCILLOSCOPE

The Type 561A Oscilloscope accepts the Type 2B67 Engine Analyzer Time-Base Plug-In and the Type 3A74 Engine Analyzer Amplifier Plug-In plus all two-series and three-series Tektronix plug-in units. The Type 561A uses an 8 x 10-cm cathode-ray tube that features an internal, illuminated graticule. An amplitude and time calibrator provides accurate squarewave voltages from 0.2 mV to 100 V P-P at a line-frequency rate. See page 151 of Tektronix Catalog 27 for further information.

TYPE 564 STORAGE OSCILLOSCOPE

The Type 564 Storage Oscilloscope uses the same plug-in units as the Type 561A and offers the added advantage of split-screen storage. Split-screen storage permits using either half of the display for storage and/or conventional displays. Storage is especially useful when making pressure measurements. 10 or 20 engine cycles can be stored on the display to detect changes of pressure, or the display can be continuously stored for up to one hour to detect pre-ignition problems. See page 155 of Tektronix Catalog 27 for further information.

ENGINE ANALYZER

TYPE 2B67 ENGINE ANALYZER TIME BASE

TIME BASE

1 μ s/div to 5 s/div and 21 calibrated steps, 1-2-5 sequence; accurate within 3%. 5X magnifier operates over full time base, accurate within 5%.

SINGLE SWEEP

Provides single display for one-shot waveform photography and storage applications. In the Rotational Function Generator mode of operation, single displays of either 360° (2 cycle) or 720° (4 cycle) are possible.

TRIGGER

Automatic, manual, or free-run operation; triggering on + or - slope from an internal, line frequency or external source. In external trigger, a signal from the Rotational Function Generator is available for triggering.

ROTATIONAL FUNCTION AMPLIFIER

Accepts inputs from the Rotational Function Generator providing horizontal displays of piston volume or crank angle. Crank-angle degree markers are internally coupled to Channel 2 of the Type 3A74 Engine Analyzer Amplifier.

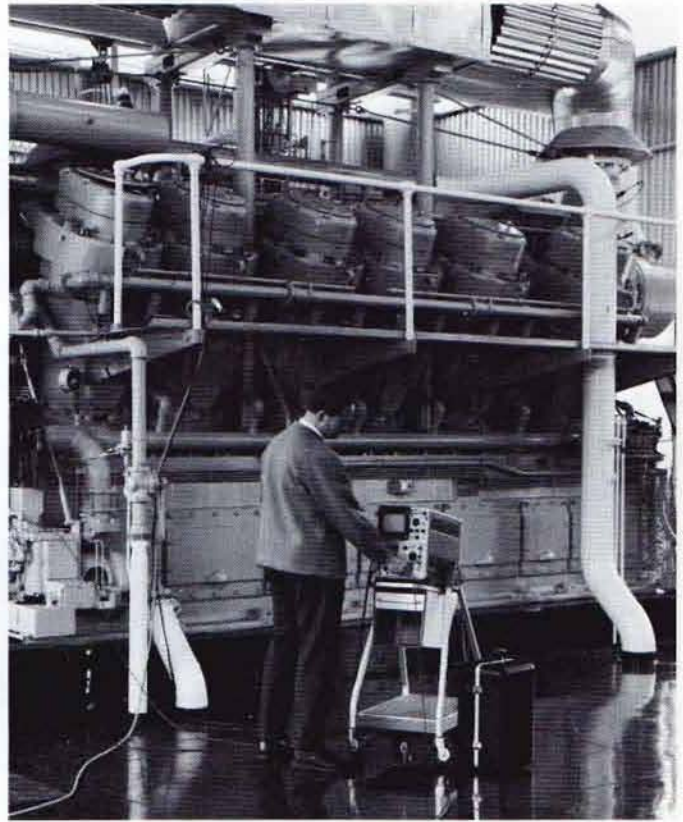

TYPE 3A74 ENGINE ANALYZER AMPLIFIER

The Type 3A74 Engine Analyzer Amplifier is a four-channel plug-in unit featuring simultaneous displays of pressure, crank-angle markers, engine vibration, and ignition. Channel 1 is a charge amplifier designed for use with the pressure transducer; Channel 2 provides a crank-angle marker display from the Rotational Function Generator plus the magnetic pickup display of top dead center; Channel 3 and Channel 4 are identical amplifiers used for vibration and ignition displays.

CHARGE AMPLIFIER, CHANNEL 1

1 psi/div to 500 psi/div in 1-2-5 sequence; accurate within 3%. Frequency response: Restore Time — Long is from 0.05 Hz to 10 kHz, Short is from 0.5 Hz to 10 kHz. Maximum charge signal is 0.6 μ C (micro coulomb) at 10 kHz, increasing to 2 μ C at 2.75 kHz. Restore Time is at least 3 s in the Long position, at least 0.3 s in the Short position. Display noise is less than 0.15 pC (pico coulomb) per 1000 pF of source capacitance, with 1 psi/div and gain set to 100 pC/psi.

CHANNELS 2, 3 and 4

0.02 V/div to 10 V/div in 9 calibrated steps, 1-2-5 sequence; accurate within 3%. Uncalibrated, continuously variable between steps and to approx 25 V/div. Bandwidth is DC to 2 MHz at 3-dB down. AC-coupled low-frequency response is 2 Hz. Input characteristics are 1 M Ω paralleled by approx 47 pF. Maximum input voltage is 600 V (combined DC plus AC).

ENGINE ANALYZER ACCESSORIES PRESSURE TRANSDUCER

The Pressure Transducer and cooling adapter with Bacharach fittings are connected to the cylinder pressure cock and are designed for use at engine speeds up to 1000 RPM. The piezoelectric Pressure Transducer, when used with the charge amplifier of the Type 3A74 Engine Analyzer Amplifier and the included 50-ft low-noise cable, has the following characteristics.

PRESSURE RANGE is 0 to 3000 psi.

DEFLECTION FACTOR is 1 psi/div to 500 psi/div in 1-2-5 sequence, accurate within 5% throughout calibrated range. Maximum overload pressure is 300%.

BANDWIDTH in the Long Restore Time position is from 0.05 Hz or less to at least 10 kHz; in the Short Restore Time position, from 0.5 Hz or less to at least 10 kHz.

RESTORE TIME in the Long position is at least 3 seconds; in the Short position is at least 0.3 seconds.

NOISE is not discernible with the 50-ft low-noise cable supplied.

TEMPERATURE RANGE is from -40°C to +150°C. A cooling adapter is supplied for environmental conditions above +150°C.

VIBRATION TRANSDUCER

The piezoelectric Vibration Transducer has a magnetic mount and is used with Channel 2, 3 or 4 of the Type 3A74 Engine Analyzer Amplifier with the included 50-ft low-noise cable.

ENGINE ANALYZER

TRANSDUCER SENSITIVITY is nominally 6 mV/g (4.5 mV/g with the included cable). Exact value is shown with the calibration chart supplied with the transducer.

BANDWIDTH is from 40 Hz to 15 kHz with a resonant frequency at approx 10 kHz.

MAXIMUM ACCELERATION is 1000 g's.

TEMPERATURE RANGE is from -40°C to $+150^{\circ}\text{C}$.

IGNITION PICKOFF

The Ignition Pickoff, when used with Channel 2, 3 or 4 with the Type 3A74 Engine Analyzer Amplifier and the included 50-ft low-noise cable, has the following characteristics.

ATTENUATION is nominally 1000X. Exact attenuation is determined by the capacitance between the pickoff and the secondary lead under test. The oscilloscope calibrator and a piece of ignition cable can be used to calibrate the ignition pickoff and the vertical amplifier.

TIME CONSTANT is at least 6.5 ms.

MAGNETIC PICKUP

The Magnetic Pickup, when used with Channel 2 of the Type 3A74 Engine Analyzer Amplifier and the included 20-ft or 50-ft low-noise cable, has the following characteristics.

OUTPUT VOLTAGE is at least 15 V P-P at 1000 inch/s and a clearance gap of 0.005 inch using a 20-pitch, 30-tooth ferrous metal gear.

COIL RESISTANCE is 90 Ω to 110 Ω .

COIL INDUCTANCE is 26 mH to 40 mH.

TEMPERATURE RANGE is from -54°C to $+107^{\circ}\text{C}$.

ROTATIONAL FUNCTION GENERATOR

The Rotational Function Generator is mechanically coupled to the engine under test and generates 10°, 60° and 360° markers. Crank-Angle Markers are displayed on Channel 2 of the Type 3A74 Engine Analyzer. The Rotational Function Generator is mechanically timed to an engine reference point by comparing the display of the top dead center mark of the magnetic pickup from the fly wheel with the 0°/360° pulse generated by the function generator. The Rotational Function Generator also generates a sawtooth ramp for displays related to crank angle, and a sinewave that is equivalent to piston volume for P-V curves. The Rotational Function Generator, when used with the Type 2B67 Engine Analyzer Time Base and the included 20-ft cable supplied, has the following characteristics.

MAXIMUM RPM is 20,000 revolutions per minute.

DEGREE MARKER angular accuracy is within 1°.

SHAFT LOAD actual and radial is 10 lb maximum.

CRANK-ANGLE MARKERS are generated every 10°, a pulse of larger amplitude every 60°, and a pulse riding on a pedestal every 360°. The markers are internally coupled to Channel 2 and have an amplitude of at least a division of the display. The magnetic pickup signal can be superimposed on Channel 2 to permit timing of the function generator markers to the engine under test.

CRANK ANGLE displays provide 350° of useable display related directly to crank angle and incremental accuracy is within 3% of full scale display.

PISTON VOLUME displays have an incremental accuracy within 3% of full scale display. The phase shift is 0.5° or less at 20,000 RPM.

TEMPERATURE RANGE is from -15°C to $+75^{\circ}\text{C}$.

ORDERING INFORMATION

TYPE 561A P7 OSCILLOSCOPE, without plug-in units

OR

TYPE 564 STORAGE OSCILLOSCOPE, without plug-in units

TYPE 2B67 ENGINE ANALYZER TIME BASE, order Type 2B67 MOD 730A

Includes: Engine Analyzer instruction manual (070-0890-00).

TYPE 3A74 ENGINE ANALYZER AMPLIFIER, order Type 3A74 MOD 730A

Includes: Engine Analyzer instruction manual (070-0890-00).

ENGINE ANALYZER ACCESSORIES

Order 015-0126-00

Includes: rotational function generator (015-0108-00); pressure transducer (015-0117-00); vibration transducer (015-0116-00); magnetic transducer (015-0119-00); capacitive ignition pickup (012-0139-00); 20-ft function generator cable (012-0140-00); adapter plate (386-1453-00); extension shaft kit (015-0124-00); cooling adapter (015-0118-00); 3 50-ft low-noise coax cables (012-0137-00); 20-ft low-noise coax cable (012-0136-00); clip marker cable kit (016-0127-00); 18-inch coax cable (012-0076-00); Type 3A74 charge amplitude calibrator (011-0095-00); carrying case/trays (202-0170-01); instruction manual (070-0890-00).

For price and availability information on specific items included in the Engine Analyzer accessory package, contact your nearby Tektronix Field Office.

RECOMMENDED OPTIONAL ACCESSORIES

CAMERAS

C-12 with beam-splitting mirror for straight-on viewing and use of optional projected graticule, f/1.9—1:0.85 lens, Polaroid Land* Pack Film back, order C-12

Type 561A or Type 564 to C-12 Camera adapter, order 016-0217-00

Projected Graticule for 115 V, order 016-0204-00

Projected Graticule for 230 V, order 016-0234-00

Camera carrying case, order 016-0208-01

SCOPE-MOBILE® CART

Model 201-1 for Type 561A: 9-position tilt-lock oscilloscope tray, order 201-1

TRIPOD

For easy mounting and positioning of the Rotational Function Generator, order 016-0253-00

ROTATIONAL FUNCTION GENERATOR

Rotational Function Generators can be permanently attached to a number of engines for use with the Engine Analyzer when needed, order 015-0108-00



TYPE 602 5-INCH DISPLAY UNIT

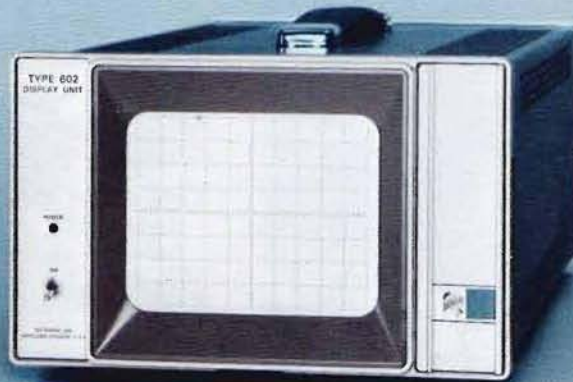

- 1-MHz X AND Y BANDWIDTH
- 100 mV/cm X AND Y DEFLECTION FACTORS
- X-Y PHASE DIFFERENCE WITHIN 1° TO 1 MHz
- UNIFORMLY SMALL SPOT SIZE
- DC-COUPLED Z AXIS
- ALL SOLID-STATE DESIGN

The Type 602 Display Unit is a compact, solid-state instrument with excellent resolution providing accurate displays of information from X, Y and Z signal inputs. Application areas are: phase shifts and frequency ratios using *Lissajous* figures, graphic and alphanumeric displays from computers, high-resolution raster displays with intensity modulation and Y-T plots of amplitude versus time displays.

Permanent records of the Type 602 display are provided on Polaroid prints using the Tektronix C-30A Camera with adapter. Two Type 602's may be mounted side-by-side using an optional rack adapter.

CHARACTERISTIC SUMMARY

VERTICAL (Y) AND HORIZONTAL (X)

BANDWIDTH—DC to 1 MHz.

DEFLECTION FACTOR—Vertical 90 mV/cm to 135 mV/cm.
Horizontal 90 mV/cm to 110 mV/cm. Internally variable.

PHASE DIFFERENCE—Within 1° between X and Y to 1 MHz.

INPUT R and C— ≈ 100 k Ω and ≈ 30 pF.

MAXIMUM INPUT VOLTAGE— ± 10 V DC plus peak AC.

Z AXIS

BANDWIDTH—1 MHz.

SIGNAL AMPLITUDE—0.0 to +1 V.

INPUT R and C— ≈ 100 k Ω and ≈ 70 pF.

MAXIMUM INPUT VOLTAGE— ± 10 V DC plus peak AC.

CRT

DISPLAY AREA—8 x 10 cm.

PHOSPHOR—P31.

OTHER

POWER REQUIREMENTS—90 to 136 or 180 to 272 VAC, 48 to 440 Hz. 50 W at 115 VAC, 60 Hz.

VERTICAL (Y) AND HORIZONTAL (X) AMPLIFIERS



Signal input is via BNC connectors on the rear panel.

BANDWIDTH

DC to 1 MHz at 3-dB down.

DEFLECTION FACTOR

Vertical—90 mV/cm to 135 mV/cm, internally variable.

Horizontal—90 mV/cm to 110 mV/cm, internally variable.

PHASE DIFFERENCE

Not more than 1° between X and Y amplifiers up to 1 MHz.

BEAM POSITION

Front panel vertical and horizontal position ranges permit setting zero signal position to any point on screen. Position shift is not more than 1 mm/h after 20-min warm up.

MAXIMUM INPUT VOLTAGE

± 10 V DC plus peak AC.

INPUT RC

100 k Ω $\pm 10\%$ paralleled by 30 pF or less.

RECOMMENDED SOURCE IMPEDANCE

1 k Ω or less.

Z AXIS

A linear Z-axis amplifier permits intensity modulation of the writing beam. Analog input: DC to 1 MHz over 0.0 V to +1 V range. Signal input is via a BNC connector on the rear panel.

MAXIMUM INPUT VOLTAGE

± 10 V DC plus peak AC.

INPUT RC

100 k Ω paralleled by approx 70 pF.

RECOMMENDED SOURCE IMPEDANCE

1 k Ω or less.

CRT

TEKTRONIX CRT

5-inch flat-faced rectangular CRT with P31 phosphor standard, P7 phosphor optional.

DISPLAY SIZE

8 cm vertically and 10 cm horizontally.

GRATICULE

Standard graticule—internal, parallax-free, variable illumination.

Optional graticule—internal 8 x 10-cm outline (no graticule lines).

TRACE WIDTH

Maximum trace width within the 8 x 10-cm display area is 14 mils at 0.5- μ A beam current.

DISPLAY LINEARITY

The difference in any 2-cm deflection on the vertical axis is not more than 1%. The difference in any 2-cm deflection on the horizontal axis is not more than 6%.

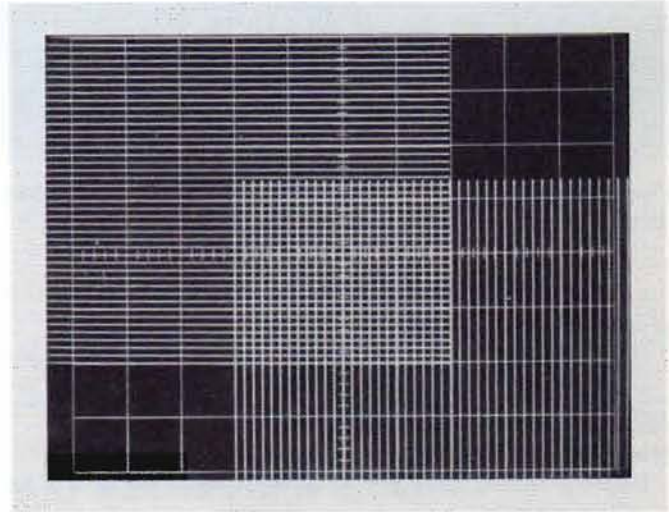

The Type 602 provides uniform line width and linearity over full 8 x 10-cm display area.

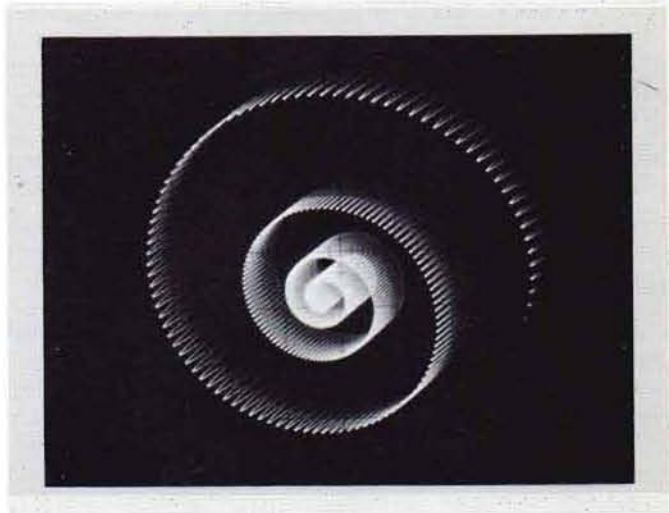

Displayed is a low-frequency damped sine wave with 90° phase difference between X and Y inputs. A 1-MHz timing sine wave is also applied to the X, Y and Z input. Intensity modulation with the 1-MHz timing waveform adds the third display parameter and creates the illusion of depth.

TYPE 602

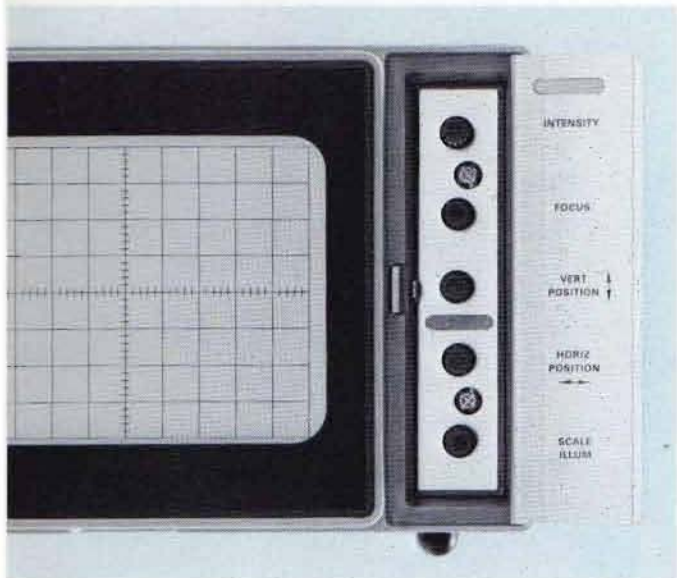

Operating controls are conveniently located behind front-panel door.

OTHER CHARACTERISTICS

POWER REQUIREMENTS

90 to 136 VAC or 180 to 272 VAC, 48 to 440 Hz. 50 watts at 115 VAC, 60 Hz. Rear panel selector provides rapid accommodation for six line-voltage ranges.

TEMPERATURE

Electrical specifications are valid over the range of 0°C to +50°C ambient.

FINISH

Blue vinyl painted cabinet, aluminum construction.

DIMENSIONS AND WEIGHT (cabinet included)

Height	6 in	15.3 cm
Width	8½ in	21.6 cm
Depth	17¾ in	44.1 cm
Net Weight	17¼ lb	7.8 kg

INCLUDED STANDARD ACCESSORIES

Smoke gray filter, installed (378-0586-00); two instruction manuals (070-0799-00).

TYPE 602 MOD 146B DISPLAY UNIT

Standard instrument, without cabinet, for mounting in rack adapter. Requires 5¼-inch vertical rackmounting space.

OPTIONAL ACCESSORIES

Optional accessories serve to extend the usefulness of the Type 602 in certain applications.

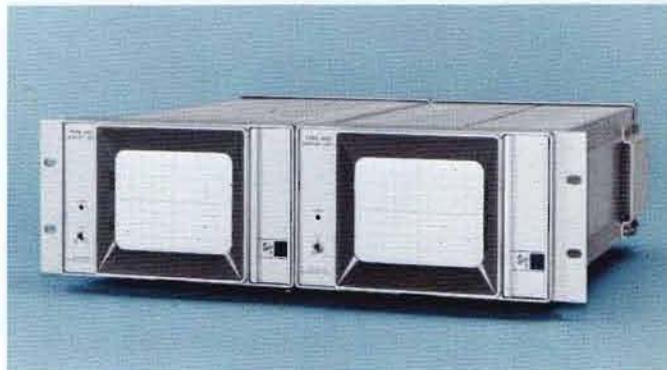

5¼-INCH RACK ADAPTER FOR 601, 602, and 528

For mounting two instruments side-by-side in a standard 19-inch rack, order 016-0115-00

PANEL ASSEMBLY

For covering ½ of rack adapter when only one Type 602 is rackmounted, order 016-0116-00

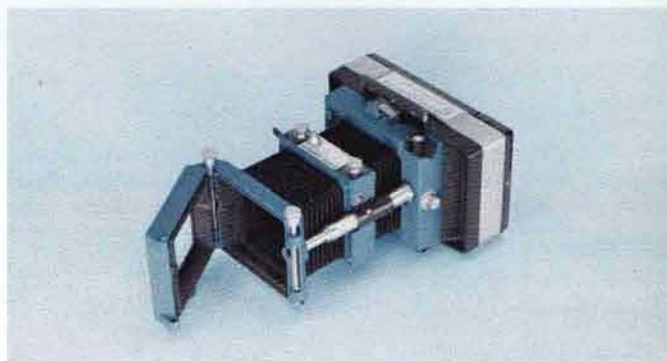

C-30A CAMERA

f/1.9 lens, magnification variable from 1.5:1 to 0.7:1; Polaroid Land* Pack-Film Back, order C-30A-P

Type 602 to C-30A Camera adapter, order 016-0248-00

C-30A CAMERA CARRYING CASE

Constructed of heavy-gage, high-impact plastic, has foam-backed, vacuum-formed styrene liner. Holds C-30A Camera, all standard accessories and extra film.

Order 016-0126-00

*Registered Trademark, Polaroid Corporation.



TYPE S-3 350-ps SAMPLING HEAD



- **COMPACT PROBES**
- **100 k Ω , 2.3-pF INPUT RC**
- **DC-to-1 GHz BANDWIDTH**
- **DISPLAYED NOISE LESS THAN 3 mV (unsmoothed)**

The Type S-3 Sampling Head is a low-noise, 350-ps risetime, sampling-probe unit with a 100-k Ω , 2.3-pF input impedance. A switch on the Sampling Head selects a DC offset of X1 or X2 while maintaining a 2 mV/div deflection factor.

The Type S-3 Sampling Head is designed for use with the Type 3S2, 3S5 and 3S6 Dual-Trace Sampling Units and can be plugged in or attached by an optional Sampling-Head extender for remote use. When used with the Type 3T2 Random Sampling Sweep Unit, the triggering event may be displayed on the screen without the use of delay lines or a pretrigger.

CHARACTERISTICS

RISETIME

- Probe only, 350 ps or less.
- With 10X attenuator, 400 ps or less.
- With 100X attenuator, 500 ps or less.

BANDWIDTH

Probe only is equivalent to DC-to-1 GHz at 3-dB down.

TRANSIENT RESPONSE

- As observed with Type 284 Pulse Generator
- Probe only: aberrations in the first 2 ns following a step are +8%, -2% or less, total of 10% or less P-P; +1%, -1% or less, total of 2% or less P-P after 2 ns.
- With 10X attenuator: aberrations in first 5 ns following a step transition are +2%, -5% or less, total of 7% or less P-P; +1%, -1% or less, total of 2% or less P-P after 5 ns.
- With 100X attenuator: aberrations in the first 5 ns following a step transition are +5%, -8% or less, total of 13% or less P-P; +2%, -5% or less, total of 7% or less P-P from 5 ns to 30 ns; +1%, -1% or less, total of 2% or less P-P after 30 ns.

DISPLAYED NOISE

Probe only, 3 mV or less, measured tangentially, referred to the probe tip.

SIGNAL RANGE

Variable DC offset allows signals between +1 V and -1 V, X1 range; or +2 V and -2 V, X2 range to be displayed at 2 mV/div. For best dot-transient response with random-sampling sweep unit, signal amplitude should be less than 1 V P-P. The signal range may be increased X10 or X100 with the use of the probe attenuators.

PROBE AND ATTENUATOR ACCURACY

Accuracy is within 0.5% probe only, within 1.75% with 10X attenuator, within 2.5% with 100X attenuator, in addition to the accuracy of the vertical plug-in unit.

INPUT CHARACTERISTICS

- Probe only is 100 k Ω paralleled by 2.3 pF.
- With 10X attenuator, 1 M Ω paralleled by 2 pF.
- With 100X attenuator, 1 M Ω paralleled by 1.75 pF.
- With coupling capacitor 4.5 pF; probe only and coupling capacitor time constant is approx 100 μ s.

WEIGHT

Net weight 3/4 lb 0.34 kg

INCLUDED STANDARD ACCESSORIES

10X attenuator (010-0364-00), 100X attenuator (010-0365-00), coupling capacitor (011-0098-00), probe tip (206-0114-00), bayonet-ground adapter (013-0085-00), two test-point jacks (131-0258-00), 5 1/2-inch ground lead (175-1017-00); 12 1/2-inch ground lead (175-1018-00); 3-inch cable assembly (175-0249-00); three probe clips (344-0046-00); end cap (200-0834-00); two end caps (200-0835-00); probe holder (352-0090-00); retractable hook tip (013-0097-00); 50- Ω voltage pickoff (017-0077-01), carrying case (016-0121-00), manual (070-0765-00).

OPTIONAL ACCESSORIES

- Probe tip-to-BNC adapter, order 013-0084-00
- Probe tip-to-GR adapter, order 017-0076-00



TYPE S-4

25-ps SAMPLING HEAD



- 25-ps SAMPLING HEAD
- DC-to-14 GHz BANDWIDTH
- RANDOM NOISE LESS THAN 10 mV (unsmoothed)

The Type S-4 Sampling Head is a 25-ps risetime unit with a 50- Ω input impedance. It is designed for use with the Type 3S2, 3S5 and 3S6 Dual-Trace Sampling Units. The Type S-4 can be plugged into the sampling unit or attached by a Sampling-Head extender for remote use. When used with the Type 3T2 Random Sampling Sweep Unit, the triggering event may be displayed on screen without the use of delay lines or a pretrigger.

CHARACTERISTICS

RISETIME

Less than or equal to 25 ps.

BANDWIDTH

Equivalent to DC-to-14 GHz at 3-dB down.

TRANSIENT RESPONSE

Aberrations as observed with the Type S-50 Pulse Generator are +10%, -10% or less.

RANDOM NOISE

Equivalent to an input signal of 10 mV or less, unsmoothed; 5 mV, smoothed (tangentially measured).

SIGNAL RANGE

Variable DC offset allows signals between +1 V and -1 V limits to be displayed at 2 mV/div. For best dot-transient response with random-sampling sweep unit, signal amplitude should be less than 500 mV P-P.

INPUT CHARACTERISTICS

Nominally 50 Ω . Safe overload ± 5 V. 3-mm input connector.

WEIGHTS

Net weight	$\frac{3}{4}$ lb	0.34 kg
Domestic shipping weight	$\approx 1\frac{1}{2}$ lb	≈ 0.68 kg

INCLUDED STANDARD ACCESSORIES

2-ns cable with 3-mm connectors (015-1005-00); 10X 50- Ω 3-mm attenuator (015-1003-00); GR874 to 3-mm male adapter (015-1007-00); 3-mm male-to-male adapter (015-1011-00); instruction manual (070-0896-00).

TYPE S-50

25-ps PULSE GENERATOR



- 25-ps PULSE RISETIME
- 400-mV PULSE AMPLITUDE
- 100-ns PULSE WIDTH

The Type S-50 Pulse Generator Head is a high-speed, tunnel-diode step generator designed for use in the Type 3S2, 3S5 and 3S6 Sampling Unit or in the Type 285 Power Supply Unit. The Type S-50 when used with the Type S-4 Sampling Head provides high-resolution 35-ps TDR measurements. The Type S-50 is also used for verification of sampling system risetimes. A pretrigger output allows operation with sequential sampling systems.

CHARACTERISTICS

PULSE OUTPUT

Risetime is 25 ps or less. Amplitude into 50 Ω is at least 400 mV, positive going. Pulse duration is 100 ns, pulse repetition rate is 25 kHz. Pulse aberrations are +10%, -10%, or less as observed with the Type S-4 Sampling Head.

PRETRIGGER OUTPUT

Risetime is 400 ps or less. Amplitude into 50 Ω is at least 180 mV, positive going. Pretrigger pulse duration is 3 ns. Pretrigger occurs 75 ns (± 5 ns) before the pulse output. Pretrigger to pulse output jitter is 10 ps or less.

TRIGGER OUTPUT

Risetime is 200 ps or less. Amplitude into 50 Ω is at least 200 mV, positive going. Trigger pulse duration is 100 ns. The trigger output occurs in time coincidence with the pulse output.

POWER REQUIREMENTS

The necessary power is provided from the Type 3S2, 3S5, 3S6 or Type 285 Power Supply.

OUTPUT CONNECTORS

Pulse output uses a 3-mm connector. Pretrigger output and trigger output use BSM connectors. A pretrigger output from the rear of the Type S-50 provides a pretrigger pulse for internal triggering of the sampling sweep unit.

WEIGHTS

Net weight	$\frac{3}{4}$ lb	0.34 kg
Domestic shipping weight	$\approx 1\frac{1}{2}$ lb	≈ 0.68 kg

INCLUDED STANDARD ACCESSORIES

Instruction manual (070-0897-00).



TYPE S-51

1-to-18 GHz TRIGGER COUNTDOWN HEAD



The Type S-51 Trigger Countdown Head is a free-running tunnel-diode oscillator designed to provide stable sampling displays of signals up to 18 GHz. The Type S-51 may be used with the Type 3S2, 3S5 and 3S6 Sampling Units in place of one of the Sampling Heads, or it may be operated separately with the Type 285 Power Supply. The Type S-51 has a front-panel synchronizing control that syncs the oscillator frequency to a sub-harmonic of the input signal. The output from the Type S-51 is available at a front-panel trigger output connector or through a rear-panel connector for internal triggering. The output signal is a direct countdown from the input display and permits triggering by a standard sampling time-base unit.

CHARACTERISTICS

INPUT SIGNAL

Frequency range is 1 GHz to 18 GHz. Stable synchronizing on signals 100 mV or less P-P, 5 V, P-P maximum.

INPUT CHARACTERISTICS

50-Ω 3-mm connector. Open termination paralleled by 1 pF.

TRIGGER OUTPUT

At front panel trigger output is at least 200 mV into 50 Ω, Type BSM connector. Internal trigger output is at least 100 mV into 50 Ω, internally connected to sampling sweep unit. Jitter is 10 ps or less, with signals from 5 GHz to 18 GHz; 15 ps or less with signals from 1 GHz to 5 GHz. Trigger kickout at signal input connector is 400 mV or less, kickout occurs between successive samples.

POWER REQUIREMENTS

The necessary power is provided from the Type 3S2, 3S5, 3S6 or Type 285 Power Supply.

WEIGHT

Net weight	3/4 lb	0.34 kg
Domestic shipping weight	1 1/2 lb	0.68 kg

INCLUDED STANDARD ACCESSORIES

Instruction manual (070-0898-00).

TYPE 285

POWER SUPPLY



- ACCEPTS ONE TYPE S-50 SERIES HEAD
TYPE S-50 PULSE GENERATOR HEAD
TYPE S-51 TRIGGER COUNTDOWN HEAD

The Type 285 Power Supply is designed for use with either the Type S-50 Pulse Generator Head or the Type S-51 Trigger Countdown Head. The Type 285 provides the regulated power supplies necessary to power one Type S-50 Series Head. It also provides a front panel trigger output jack. The trigger output jack provides the internal trigger pulse from the plug-in Head to the front panel of the Type 285.

CHARACTERISTICS

POWER REQUIREMENTS

90 V to 136 V or 180 V to 272 V, 50 Hz to 400 Hz, 10 watts at 115 V and 60 Hz. Slide switch on rear panel selects high or low voltage operation.

TRIGGER OUTPUT

BSM Connector provides internal trigger output of Type S-50 Series Heads to the front panel.

DIMENSIONS AND WEIGHTS

Height	3 1/8 in	5.1 cm
Width	5 in	12.7 cm
Depth	8 in	20.3 cm
Net weight	3 1/8 lb	1.4 kg

INCLUDED STANDARD ACCESSORIES

3-to-2 wire adapter (103-0013-00); two instruction manuals (070-0903-00).

OPTIONAL ACCESSORIES WITH 3-mm CONNECTORS

10X 50-Ω attenuator, order 015-1003-00
5X 50-Ω attenuator, order 015-1002-00
2X 50-Ω attenuator, order 015-1001-00
2-ns 50-Ω signal cable, order 015-1005-00
5-ns 50-Ω signal cable, order 015-1006-00
50-Ω termination, order 015-1004-00

Male-to-male adapter, order 015-1011-00
Female-to-female adapter, order 015-1012-00
Male-to-GR874 adapter, order 015-1007-00
Female-to-GR874 adapter, order 015-1008-00
Male-to-7-mm adapter, order 015-1010-00
Male-to-N female adapter, order 015-1009-00



TYPE 115 PULSE GENERATOR

- 100-Hz to 10-MHz REPETITION RATE
- VARIABLE DC OFFSET
- VARIABLE RISETIME AND FALLTIME
- PAIRED, BURST, UNDELAYED AND DELAYED PULSES
- CLEAN PULSES—TOTAL ABERRATIONS $\leq 3\%$ P-P
- ± 10 VOLTS INTO 50 Ω
- SHORT-PROOF OUTPUT

OUTPUT CHARACTERISTICS (TERMINATED IN 50- Ω LOAD)		
CHARACTERISTIC	PERFORMANCE	ACCURACY
RISETIME AND FALLTIME	10 ns to 100 μ s in 4 ranges, continuously variable.	Within 5%, ± 1 ns, with RISETIME MULT or FALLTIME MULT ccw (position 1).
PERIOD	100 ns to at least 10 ms in 5 ranges, continuously variable. (MINIMUM PULSE SEPARATION—50 ns, between the 50% amplitude points of any two adjacent pulses, with risetime and falltimes set to minimum.)	Within 3% with variable in CAL position (except within 5% on 100-ns range).
DUTY FACTOR	At least 75%, limited by minimum pulse separation.	
WIDTH	50 ns to at least 500 μ s in 4 ranges, continuously variable.	Within 3% with variable in CAL position, risetime and falltime set at minimum (except within 5% on the 50-ns range).
DELAY OR BURST TIME	50 ns to at least 500 μ s in 4 ranges, continuously variable (refer to pulse separation performance limit above).	Within 3%, ± 10 ns with variable in CAL position.
AMPLITUDE	3 ranges, continuously variable. At least ± 10 V to less than ± 100 mV with MULTIPLIER at X1, ± 5 V to ± 50 mV with MULTIPLIER at X.5 and ± 2 V to ± 20 mV with MULTIPLIER at X.2.	The X.5 and X.2 MULTIPLIER positions are referenced to the amplitude of the X1 MULTIPLIER position. They are accurate within 5%.
ABERRATIONS	+3%, -3%, total 3% P-P, or 200 mV times the DC OFFSET AND AMPLITUDE MULTIPLIER settings, whichever is greater.	
DC OFFSET	3 ranges, continuously variable. At least ± 5 V with MULTIPLIER at X1, at least ± 2.5 V with MULTIPLIER at X.5, and at least ± 1 V with MULTIPLIER at X.2.	

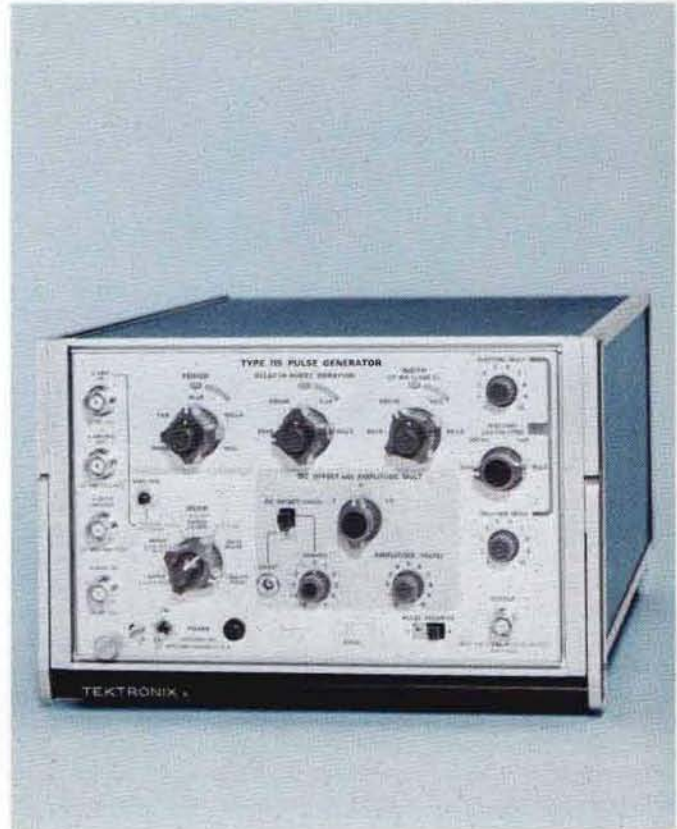

The Type 115 is a 10-MHz, 10-volt, general-purpose pulse generator with separately variable risetime, falltime, width, delay, period, amplitude and baseline offset. It is intended for use in applications where a variety of pulse amplitudes, polarities, shapes and other characteristics are required.

OPERATING MODES

GATED

Provides output pulses for the duration of input gate. First pulse is nearly coincident with input gate and recurs at a repetition rate determined by PERIOD control setting.

BURST

Provides output pulses for the duration of the burst time when initiated by external triggering pulse. Pulse repetition rate determined by PERIOD control. The first pulse in the burst will lag the trigger pulse initiating the burst by an amount dependent upon risetime selected.

PAIRED PULSES

Provides pairs of pulses; one at the time of normal undelayed pulse, and one at the end of delay time. Pairs recur at repetition rate set by PERIOD control.

DELAYED PULSE

Provides pulse at the end of delay time.

UNDELAYED PULSE

Sequence of pulses with repetition rate set by PERIOD control.

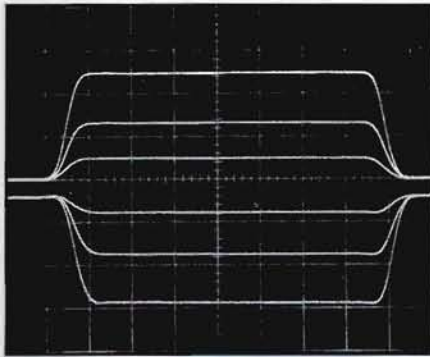

Multiple exposure from a fast-risetime oscilloscope showing typical waveform aberrations for positive and negative polarities at various amplitude settings. 20 ns/cm sweep time and 4 V/cm deflection factor.

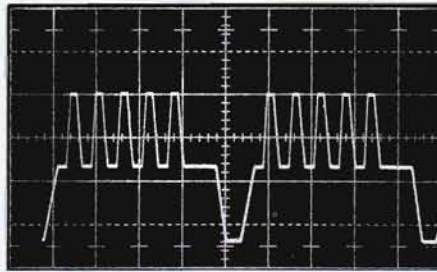

Single exposure showing combined outputs of two Type 115's. The burst of pulses on top of the positive pedestal was triggered by the + delayed trigger from the instrument generating the pedestal. 10 μ s/cm sweep time and 2 V/cm deflection factor.

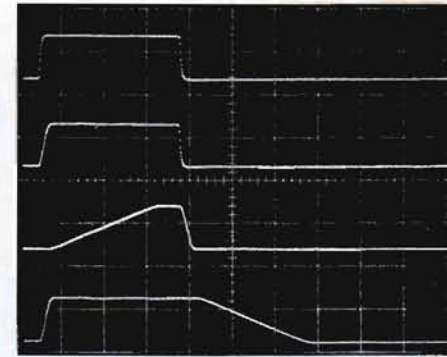

Multiple exposure showing variable risetime and falltime. 500 ns/cm sweep time and 10 V/cm deflection factor.

TRIGGERING

A two-position front-panel switch provides selection of internal or external trigger source. A manual pushbutton provides a means to produce a single undelayed pulse, delayed pulse, pulse pair or burst of pulses.

INPUTS

+ TRIGGER

	PULSE	SINEWAVE
FREQUENCY	At least 0.5 V/ μ s rate of rise	1 kHz to 10 MHz
MINIMUM AMPLITUDE	+2 V	2 V peak
MAXIMUM AMPLITUDE	+20 V, decreasing to +4 V at 10 MHz	20 V peak, decreasing to 4 V peak at 10 MHz

+ GATE

Accepts gate from +2 V to +20 V.

AUXILIARY OUTPUTS

+ PRETRIGGER

At least 2 V into 1 k Ω .

+ DELAYED TRIGGER

At least +2 V into 1 k Ω .

OTHER CHARACTERISTICS

OPERATING TEMPERATURE

Instrument operating specifications are valid over an ambient temperature range of 0° C to +50° C.

POWER REQUIREMENTS

90 to 136 VAC or 180 to 272 VAC, 48 to 66 Hz, 115 watts at 115 VAC, 60 Hz. Rear panel selector provides rapid accommodation for six line-voltage ranges.

DIMENSIONS AND WEIGHTS

Height	6 in	17.1 cm
Width	9 in	22.8 cm
Depth	15 $\frac{7}{8}$ in	42.0 cm
Net weight	15 lb	6.8 kg
Domestic shipping weight	\approx 21 lb	\approx 9.6 kg
Export-packed weight	\approx 29 lb	\approx 13.2 kg

INCLUDED STANDARD ACCESSORIES

50- Ω , 5-W termination (011-0099-00); 50- Ω BNC cable (012-0057-01); 3 to 2-wire adapter (103-0013-00); two instruction manuals (070-0786-00).

TYPE 115 PULSE GENERATOR MOD 146B (without cabinet)

Same accessories as above with addition of a detachable power cord (161-0031-00).

OPTIONAL ACCESSORIES

RACK ADAPTER

Converts MOD 146B versions of Type 106, 114, 115, 184, 191 and 284 generators for rackmounting. Any combination of two of these instruments can be mounted side-by-side in a 19-inch rack, in only 5 $\frac{1}{4}$ inches of panel height. Up to four Type 284's can be mounted side-by-side, or two Type 284's can be mounted with one of the other generators. Adapter provides forced-air ventilation and shielding between compartments. Blank panels to cover unused openings are available when only one generator is installed. Blank panels are not supplied with the rack adapter.

RACK ADAPTER (016-0086-00)

$\frac{1}{2}$ -WIDTH BLANK PANEL (016-0081-00)

$\frac{1}{4}$ -WIDTH BLANK PANEL (016-0109-00)



TYPE 1L40 1.5 GHz-to-40 GHz SPECTRUM ANALYZER UNIT

- **CENTER FREQUENCY RANGE**
FROM 1.5 GHz to 40 GHz
- **INTERNAL PHASE LOCK**
- **CONVENIENT WAVEGUIDE MIXERS**

The Type 1L40 extends the range of Tektronix Plug-In Spectrum Analyzers to 40 GHz. The standard coaxial mixer operates from 1.5 GHz to 12.4 GHz. Three waveguide mixer/adaptor combinations for frequencies from 12.4 GHz to 40 GHz are available as OPTIONAL accessories.

Other features include internal phase lock, calibrated dispersion, 1-kHz resolution, and use in an oscilloscope main frame with a linear time base and triggering for direct PRF measurements.

RF FREQUENCY RANGES		MINIMUM CW SENSITIVITY*	
SCALE	FREQUENCY RANGE	1-kHz RESOLUTION	100-kHz RESOLUTION
1	1.5 GHz to 4.0 GHz	≥ -110 dBm	≥ -90 dBm
2	3.8 GHz to 8.2 GHz	≥ -100 dBm	≥ -80 dBm
3	8.2 GHz to 12.4 GHz	≥ -95 dBm	≥ -75 dBm
OPTIONAL WAVEGUIDE MIXERS AND ADAPTER REQUIRED BEYOND 12.4 GHz			
4	12.4 GHz to 18 GHz	≥ -90 dBm	≥ -70 dBm
5	18 GHz to 40 GHz	≥ -80 dBm to 26.5 GHz ≥ -70 dBm to 40 GHz	≥ -60 dBm ≥ -50 dBm

*Signal + noise = 2X noise

DIAL ACCURACY— ±(2 MHz plus 1% of dial reading).

LO FREQUENCY RANGE— 1.7 GHz to 4.2 GHz.

CALIBRATED DISPERSION

1 kHz/cm to 10 MHz/cm in 1-2-5 sequence; 2 ranges, kHz/cm and MHz/cm. Dispersion accurate within 3% for all kHz/cm, 10 MHz/cm and 5 MHz/cm positions. Accuracy in other positions: 2 MHz/cm (±5%), 1 MHz/cm (±7%), 0.5 MHz/cm (±10%), 0.2 MHz/cm (±15%). The last two have equivalent kHz/cm range positions which are within 3%. Dispersion is linear within 3% for the 10-cm display.

RESOLUTION BANDWIDTH— ≤ 1 kHz to ≥ 100 kHz, cross-coupled with dispersion control but separately switchable.

DISPLAY FLATNESS—Within 1.5 dB to 12.4 GHz; within 3 dB to 40 GHz; over ±50 MHz from RF center frequency.

INCIDENTAL FM (LO + IF)—300 Hz or less at LO fundamental when phase locked.

PHASE LOCK—Internal 1-MHz reference, accurate within 0.1%. External reference requires 1 MHz to 5 MHz, 1 V to 5 V P-P.

VERTICAL DISPLAY MODES

- LOG — ≥40 dB dynamic range.
- LINEAR — ≥26 dB dynamic range.
- SQ LAW — ≥13 dB dynamic range.
- VIDEO — bandwidth from 16 Hz to 10 MHz at -3 dB points.



MAXIMUM INPUT POWER— -30 dBm for linear operation. +15 dBm (25 mW) safe diode limit.

IF ATTENUATOR—51-dB in 1-dB steps, accurate within 0.1 dB/dB.

IF GAIN—at least 50 dB.

IF CENTER FREQUENCY CONTROLS— ±25-MHz range from 5 MHz/cm to 0.2 MHz/cm, ±10 MHz at 10 MHz/cm. ±2.5-MHz range in all kHz/cm positions. FINE control has ±1 MHz and ±50-kHz range in MHz/cm and kHz/cm modes respectively.

SPURIOUS SIGNALS—Internal sources—2X noise or less.

RECORDER OUTPUT—12 mV to 20 mV with 6-cm LIN display.

WEIGHTS—Net weight 7.5 lb 3.4 kg
Domestic shipping weight ≈14 lb ≈6.4 kg
Export-packed weight ≈20 lb ≈9.4 kg

INCLUDED STANDARD ACCESSORIES

Patch cord, BNC to banana (012-0091-00); plug protector (134-0076-00); mini-plug (134-0052-00); two instruction manuals (070-0904-00).

TYPE 1L40

OPTIONAL ACCESSORIES

The following accessories extend the operational range of the 1L40 from 12.4 GHz to 40 GHz. The waveguide mixer adapter and cable are required for use with the waveguide mixers.

Waveguide Mixer Adapter (119-0104-00)

Cable Assembly (012-0115-00)

Waveguide Mixer 12.4—18.0 GHz (119-0097-00)

Waveguide Mixer 18.0—26.5 GHz (119-0098-00)

Waveguide Mixer 26.5—40.0 GHz (119-0099-00)

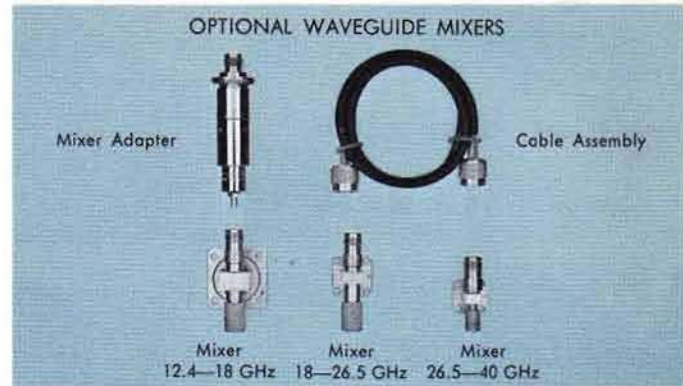

SWEPT FREQUENCY CONVERTER



- **SLAVED SPECTRUM ANALYZER-SWEPT FREQUENCY DISPLAYS**
- **50-Hz to 1-MHz CENTER FREQUENCY**
- **1-MHz DISPERSION CAPABILITY**
- **OUTPUT CONSTANT WITHIN 0.5 dB**

The Swept Frequency Converter is designed as an accessory unit to the Type 3L5 and Type 1L5 Low Frequency Spectrum Analyzer Plug-In Units. It accepts the local oscillator output from the analyzer (approx 2 MHz to 3 MHz) and converts it to a signal source slaved to the center frequency and dispersion setting of the analyzer.

The result is a signal source with center frequency range of 50 Hz to 1 MHz, single frequency (analyzer in MANUAL SWEEP mode) or swept frequency with dispersion capability of 1 MHz max to 100 Hz min. It provides for variable amplitude control and regulation for constant output within 0.5 dB. Sweep rate is controlled by the horizontal TIME BASE which sweeps the local oscillator of the analyzer and, thereby, the converter.

Applications for the Spectrum Analyzer and Swept Frequency Converter combination include filter circuit analysis and amplifier design.

CHARACTERISTICS

OUTPUT FREQUENCY—50 Hz to 1 MHz, selectable within the center frequency range of the Spectrum Analyzer.

OUTPUT VOLTAGE—4 V P-P to 8 V P-P max behind 600 Ω .

OUTPUT AMPLITUDE RANGE—at least 25 dB from max amplitude position.

OUTPUT FREQUENCY FLATNESS—within 0.5 dB into 600 Ω .

OUTPUT THIRD HARMONIC DISTORTION—within 3%, 50 Hz to 1 MHz into 600 Ω .

FREQUENCY RANGE ADJUSTMENT— +150 Hz and -150 Hz from 3 MHz.

OSCILLATOR INPUT VOLTAGE (from Spectrum Analyzer) 0.8 V P-P to 2 V P-P.

OUTPUT REGULATION

FAST—effective in preserving amplitude flatness when lowest frequency component is not less than 10 kHz and sweep rate is 10 ms/div or faster.

SLOW—used when frequency is less than 10 kHz and for sweep rates slower than 10 ms/div.

OUTPUT AMPLITUDE RECOVERY (output regulator FAST to SLOW)

10 s or less to recover to same amplitude as FAST.

OUTPUT RESISTANCE—600 Ω within 15%.

POWER REQUIREMENTS—90 VAC to 272 VAC, 50 Hz to 400 Hz.

DIMENSIONS AND WEIGHTS

Height	5 1/2 in	14.0 cm
Width	5 3/16 in	14.7 cm
Depth	5 3/4 in	14.5 cm
Net weight	3 1/2 lb	1.6 kg
Domestic shipping weight	7 1/2 lb	3.4 kg
Export-packed weight	12 lb	5.5 kg

INCLUDED STANDARD ACCESSORIES

600- Ω termination (011-0092-00); two BNC cables (012-0075-00); 3- to 2-wire adapter (103-0013-00); BNC to dual banana adapter (013-0094-00); two instruction manuals (070-0762-00).

SWEPT FREQUENCY CONVERTER, order 015-0107-00



C-30A TRACE-RECORDING CAMERA

- **VARIABLE MAGNIFICATION**
- **COMPACT, LIGHT WEIGHT**
- **EASILY-ACCESSIBLE CONTROLS**
- **OPTIONAL FILM BACKS**

The C-30A is a compact, light weight trace-recording camera designed for use with Tektronix portable instruments. It mounts directly to Type 422, 453, and 454 Oscilloscopes and Type 491 Spectrum Analyzer. Camera adapters are available for other portable and full-size oscilloscopes. The camera swings open from the left or right, as desired, and can be quickly lifted off the oscilloscope when not needed.

The C-30A uses a f/1.9 lens and features an adjustable magnification from 1:1.5 to 1:0.7. Optional film backs can be rapidly interchanged without refocusing the camera. Dark slides are included with all the film backs to permit changing backs without exposing any film.

LENS

56-mm f/1.9 oscilloscope recording lens, stops down to f/16.

SHUTTER SPEEDS

1 to 1/50 second plus Bulb and Time.

MAGNIFICATION

Variable in indexed steps of 1.5, 1.4, 1.3, 1.2, 1.1, 1.0, 0.9, 0.85, 0.8 and 0.7. At 0.7 magnification, an 8 x 10-cm or 10 x 10-div graticule (as in Type 536 and 575) can be recorded in its entirety.

FILM BACK

Polariod¹ Pack Film back accepts 3000-speed film which develops outside camera in about 10 seconds.

MECHANICAL

Lift-on mounting and swing-away hinging from left or right side. Mounts directly to Type 422, 453 and 454 Oscilloscopes and Type 491 Spectrum Analyzer. Optional camera adapters allow use with other Tektronix Oscilloscopes. Accepts Tektronix Shutter Actuator.

DIMENSIONS AND WEIGHTS

Height	5½ in	14 cm
Width	7 ⁹ / ₁₆ in	19.2 cm
Depth	10 in	25.4 cm
Net weight	4¾ lb	2.2 kg
Domestic shipping weight	≈ 9 lb	≈ 4.1 kg
Export-packed weight	≈ 14 lb	≈ 6.4 kg

INCLUDED STANDARD ACCESSORIES

Light seal for Type 422 and 491 (354-0279-00); light seal for Type 453 and 454 (354-0280-00); focus plate (387-0893-00); two instruction manuals (070-0527-00).

C-30A-P CAMERA, Pack-Film Back

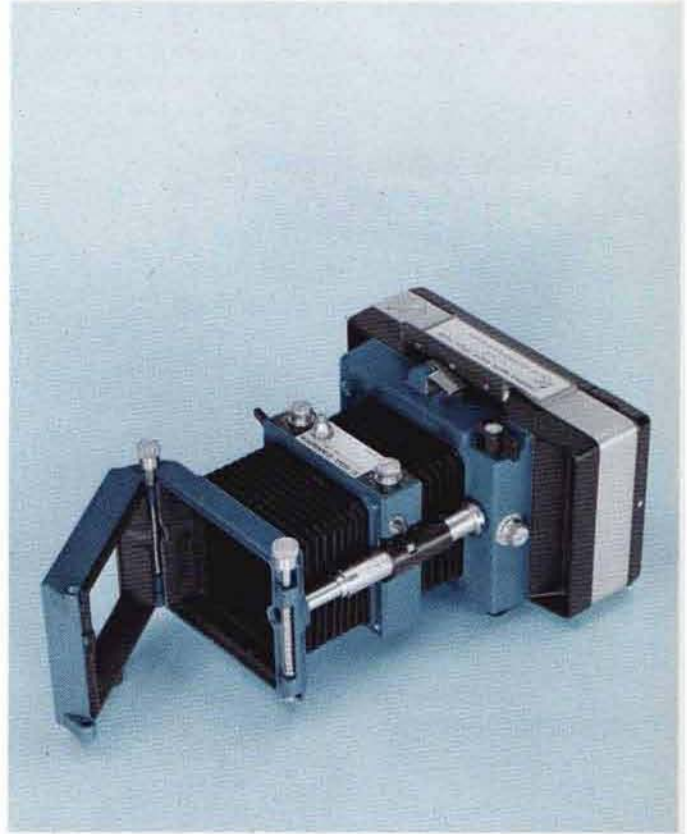

C-30A-R ROLL-FILM CAMERA is identical to the standard C-30A-P, except a Polaroid Roll-Film Back is substituted for the Pack-Film Back and the focus plate is changed to (387-0460-00).

C-30A-R CAMERA, Roll-Film Back

C-30A-G GRAFLOX² BACK CAMERA is identical to the standard C-30A-P, except a 2¼ x 3¼ Graflox Back is substituted for the Roll-Film Back and the focus plate is removed from the standard accessories. The Graflox Back has a built-in focusing screen and accepts standard cut-film holders, film-pack adapters and roll-film (120) holders.

C-30A-G CAMERA, Graflox Back

OPTIONAL LENS

A portra lens will enable the Type C-30A Camera to photograph test setups. The depth of field when using the portra lens will vary with the f stop and magnification settings used. Generally, at f/1.9 there will be very little depth of field; while at f/16, the depth of field will allow quite a wide range of distance to be accommodated, depending upon the picture sharpness required. At a distance of 21 inches, a subject area 22 inches in diameter can be covered. Lens stores inside C-30A when not used; hardware included.

Order 016-0246-00

¹Registered Trade-Mark Polaroid Corporation

²Registered Trade-Mark Graflex, Inc.



C-31 TRACE-RECORDING CAMERA

- **HIGH WRITING SPEED**
- **COMPACT, LIGHT WEIGHT**
- **EASILY-ACCESSIBLE CONTROLS**
- **OPTIONAL FILM BACKS**

The C-31 is a compact, high-performance camera designed for Tektronix portable oscilloscopes. It provides the high-writing speed required when Type 453 and 454 Oscilloscopes are operated single-shot at the fastest sweep rates. The C-31 mounts directly to these oscilloscopes, and also to the Type 422 and 491. Camera adapters are available for other portable and full-size oscilloscopes. The camera swings open from the left or right, as desired, and can be quickly lifted off the oscilloscope when not needed.

The C-31 uses an f/1.2—1:0.5 lens and Polaroid¹ 10,000-speed roll film. This combination provides the fastest writing speed available in a Tektronix Standard Camera.

LENS

56-mm f/1.2 oscilloscope recording lens, stops down to f/16.

SHUTTER SPEEDS

1 to 1/60 second plus Bulb and Time.

OBJECT-TO-IMAGE RATIO

1:0.5 records 6 x 10-div graticule (Type 453 and 454) or 8 x 10-div graticules (Type 422 and 491) on 3 1/4 x 4 1/4 Polaroid film.

FILM BACK

Polaroid Roll Film Back accepts 10,000-speed and 3,000-speed roll film which develops inside the camera in about 10 seconds.

MECHANICAL

Lift-on mounting and swing-away hinging from left or right side. Mounts directly to Type 422, 453 and 454 Oscilloscopes and Type 491 Spectrum Analyzer. Optional camera adapters allow use with other Tektronix Oscilloscopes. Accepts Tektronix Shutter Actuator.

DIMENSIONS AND WEIGHTS

Height	5 9/16 in	14.1 cm
Width	9 1/8 in	23.1 cm
Depth	10 5/8 in	27.0 cm
Net Weight	6 3/4 lb	3.1 kg

INCLUDED STANDARD ACCESSORIES

Light seal for Type 422 and 491 (354-0279-00); light seal for Type 453 and 454 (354-0280-00); focus plate (387-0460-00); two instruction manuals (070-0783-00).

C-31-R CAMERA, Roll-Film Back



C-31-P PACK-FILM CAMERA is identical to the standard C-31-R, except a Polaroid Pack-Film Back is substituted for the Roll-Film Back and the focus plate is changed to (387-0893-00). Polaroid 10,000 ASA speed film is not available in Film Packs.

C-31-P CAMERA, Pack-Film Back

C-31-G GRAFLOX² BACK CAMERA is identical to the standard C-31-R, except a 2 1/4 x 3 1/4 Graflox Back is substituted for the Roll-Film Back and the focus plate is removed from the Standard Accessories. The Graflox Back has a built-in focusing screen and accepts standard cut-film holders, film-pack adapters, and roll-film (120) holders.

C-31-G CAMERA, Graflox Back

PHOTOGRAPHIC WRITING SPEED					
C-31-R with Type 454 Oscilloscope (without Film Fogging Techniques)					
Camera and Phosphor					Minimum Photographic Writing Speed
Camera	Lens	Object- to-image ratio	Polaroid film type	CRT Phosphor	
C-31-R	f/1.2	1:0.5	410 (10,000 ASA)	P31	1600 div/ μ s (1280 cm/ μ s)
				P11	3200 div/ μ s (2560 cm/ μ s)

¹Registered Trade-Mark Polaroid Corporation

²Registered Trade-Mark Graflex, Inc.

OPTIONAL ACCESSORIES FOR C-30A & C-31 CAMERAS

FILM BACKS

Three Film Backs provide flexibility of performance and films. Dark slides are included with all the film backs to permit changing backs without exposing any film.



Pack-Film Back, Polaroid Land Film, 3 1/4 x 4 1/4, 8 exposure, order 122-0752-00
Focus Plate for above, order 387-0893-00



Roll-Film Back, Polaroid Land Film, 3 1/4 x 4 1/4, 8 exposure, order 122-0754-00
Focus Plate for above, order 387-0460-00



Graflok Back, 2 1/4 x 3 1/4 with focusing screen. Accepts standard cut-film holders, film-pack adapters, roll-film (120) holders, order 122-0755-00

CAMERA ADAPTERS

FOR OSCILLOSCOPE TYPE	PART NUMBER
310A, 317, 360	016-0241-00
321A	016-0242-00
Tektronix Oscilloscopes with 5-inch round CRT (except Type 519).	016-0243-00
Tektronix 560-Series with rectangular CRT, 529 and RM529.	016-0244-00
528, 601, 602	016-0248-00

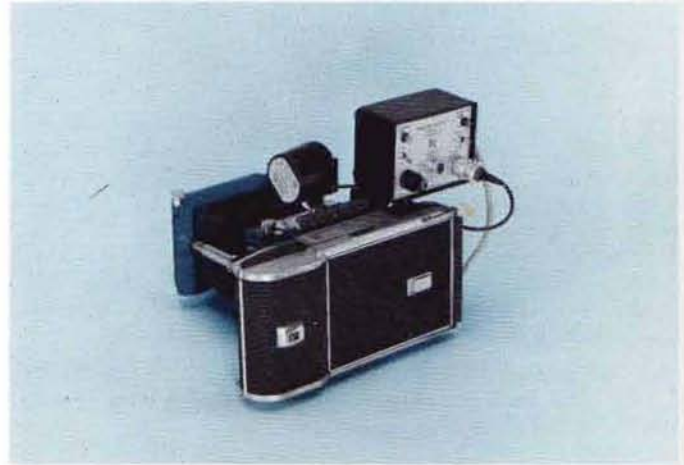

SHUTTER ACTUATOR

Model 3 Shutter Actuator permits remote actuation of C-30A and C-31 Cameras. Several actuators can be operated simultaneously by paralleling their REMOTE inputs and applying 24 VDC. The actuator mounts to the cable release bushing. The separate power supply mounts on a hinged bracket to either Polaroid Film Back. An optional bracket is available for use with Graflok Backs, and also provides more convenient access to Polaroid Roll-Film Backs, as illustrated.

Power requirement is 115 VAC, 50 to 400 Hz, or 115 VDC. Actuator, order 016-0218-01

Power Supply and hinged bracket (122-0713-00), order 016-0230-01

Power requirement is 230 VAC, 50 to 400 Hz, or 230 VDC. Actuator, order 016-0235-01

Power Supply and hinged bracket (122-0713-00), order 016-0236-01

Bracket for Graflok Back, order 407-0477-00

CARRYING CASE

The carrying case holds the C-30A or C-31 Camera and all standard accessories including up to three Film Backs, extra bezels and extra film. The case is constructed of heavy-gage, high-impact plastic and has a vacuum-formed styrene liner. Dimensions are 7 3/16 x 13 3/16 x 15 3/16 inches.

Order 016-0126-00



P6048

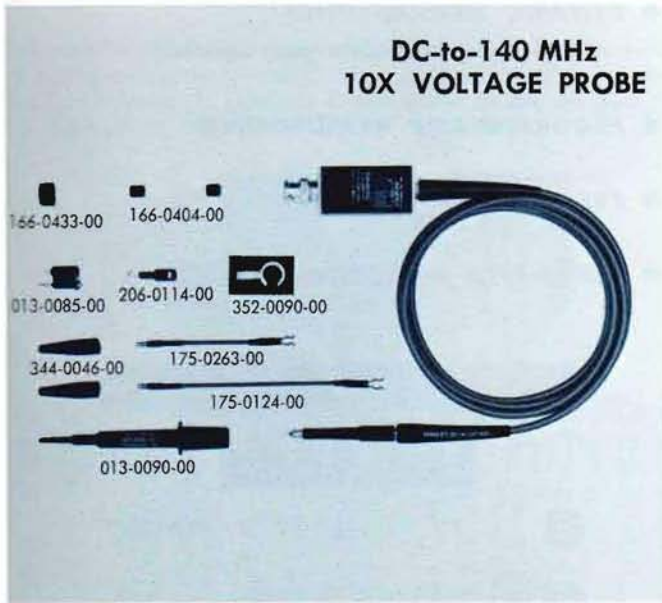

**DC-to-140 MHz
10X VOLTAGE PROBE**

The P6048 is a low-capacitance, miniature probe designed for use with Tektronix high-frequency oscilloscopes such as the Type 454 and Type 647A. It can also be compensated for use with other instruments that have an input capacitance of 14 to 21 pF and input resistance of 1 MΩ.

The P6048 offers a new level of high-frequency measurement performance with its low 1-pF input capacitance. Its small size makes it easy to use, particularly for applications involving compact circuitry.

ATTENUATION is 10X.

INPUT RESISTANCE is 1 kΩ.

INPUT CAPACITANCE is 1 pF or less.

PROBE RISETIME is 2.5 ns or less, not including risetime of oscilloscope.

ABERRATIONS are +3%, -3% or less; total of 5% P-P or less.

VOLTAGE RATING DC coupled is 20 V (DC plus peak AC); AC coupled is 200 V DC.

BANDWIDTH is DC-to-100 MHz (3-dB down) when used with Type 454 Oscilloscope; AC coupled low frequency response is 7 kHz or less.

STANDARD CABLE is 6 ft long, terminated with a BNC connector.

P6048 PROBE, order 010-0215-00

Includes: hook tip (206-0114-00); retractable-hook tip (013-0090-00); 3-inch ground lead (175-0263-00); 5-inch ground lead (175-0124-00); 2 minigator clips (344-0046-00); bayonet-ground adapter (013-0085-00); 2 insulator tips (166-0404-00); probe holder (352-0090-00); ground insulator (166-0433-00); instruction manual (070-0675-00).

OPTIONAL ACCESSORIES

Probe Tip to GR Adapter, order 017-0076-00

Probe Tip to BNC Adapter, order 013-0084-00

P6049

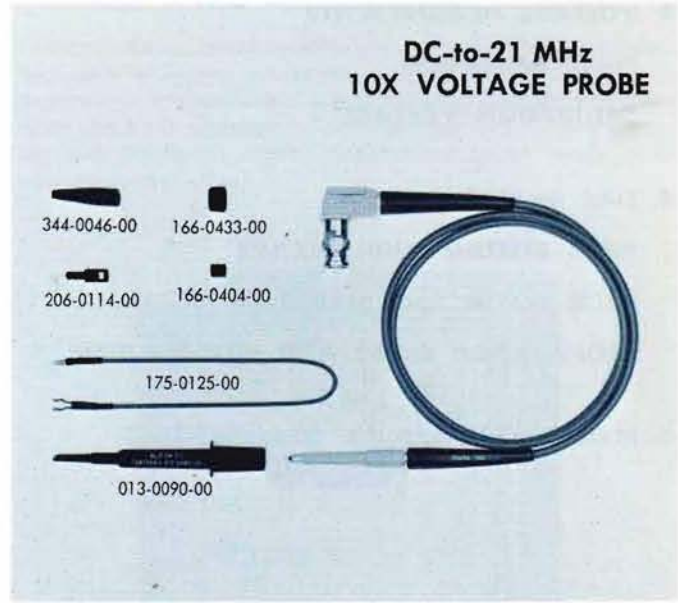

**DC-to-21 MHz
10X VOLTAGE PROBE**

The P6049 is a miniature passive probe designed for use with the Sony/Tektronix Type 323 portable oscilloscope. The probe is easily compensated for use with any instrument having an input capacitance of 43 pF to 66 pF and an input resistance of 1 MΩ.

The small P6049 is easy to use, particularly for applications involving compact circuitry. The probe has a 3.5-foot cable and a right-angle BNC connector.

ATTENUATION is 10X.

INPUT RESISTANCE is 10 megohms.

INPUT CAPACITANCE is 13.5 pF or less.

PROBE RISETIME is 17 ns or less.

ABERRATIONS are within +1.5% or -1.5%, total of 2% P-P or less.

VOLTAGE RATING is 500 V (DC plus peak AC)*.

STANDARD CABLE is 3.5 feet long, terminated with a right angle BNC connector.

P6049 PROBE, order 010-0223-00

Includes: hook tip (206-0114-00); retractable-hook tip (013-0090-00); minigator clip (344-0046-00); 12-inch ground lead (175-0125-00); insulator tip (166-0404-00); ground insulator (166-0433-00); instruction manual (070-0746-00).

OPTIONAL ACCESSORIES

Probe Tip to BNC Adapter, order 013-0084-00

*Peak voltage derating is necessary for CW frequencies higher than 4 MHz. At 10 MHz, the maximum allowable CW peak voltage is 190 V.



DIGITAL INSTRUMENTS AND SYSTEMS

VOLTAGE MEASUREMENTS

PULSE AMPLITUDE

SATURATION VOLTAGE

TIME MEASUREMENTS

PULSE RISETIME AND FALLTIME

PULSE WIDTH AND PERIOD

PROPAGATION DELAY AND STORAGE TIME

MANY OTHER SPECIFIC MEASUREMENTS

DYNAMIC MEASUREMENTS

(100 measurements per second)

PROGRAMMABLE MEASUREMENTS

PROGRAMMING UNITS

AUTOMATED MEASUREMENT SYSTEMS

ON YOUR BENCH

Type 568/230 Digital Oscilloscope System provides digital readout of measurements that are displayed in analog form on the CRT. They enable the engineer, technician or production worker to make dynamic switching time measurements with greater speed, convenience and repeatability than is possible by making measurements directly from the cathode-ray oscilloscope display. Typical measurements include pulse voltages, risetime, delay time, storage time, pulse width and many other specific measurements.

All of the measurement functions of the Type 568/230 can be externally programmed for use in high-speed automated measurement systems. The Type 568/230 can make more than 100 dynamic measurements per second, and data output connectors provide measurement results in convenient BCD code. The programming is accomplished with the use of Tektronix Program Units or by programming 157 parallel program lines using negative logic with true being ground or 2 V, and false being open or 6 V. Further information on pages 202-206 of Tektronix Catalog 27.

New programmable plug-in units extend the automated measurement capabilities of the Type 568/230. The Type 3T5 and 3T6 Programmable Sampling Units have a programmable sweep range that extends from 100 ps/div to 0.5 s/div. (pages 30 & 31)

The Type 3S5 and Type 3S6 Dual-Trace Programmable Units feature Sampling Heads and programmable vertical deflection factors and DC offset. (page 28 & 29)

Sampling Heads provide a choice of system measurement capabilities. Select the measurement performance you need today and update your performance with future Sampling Heads.

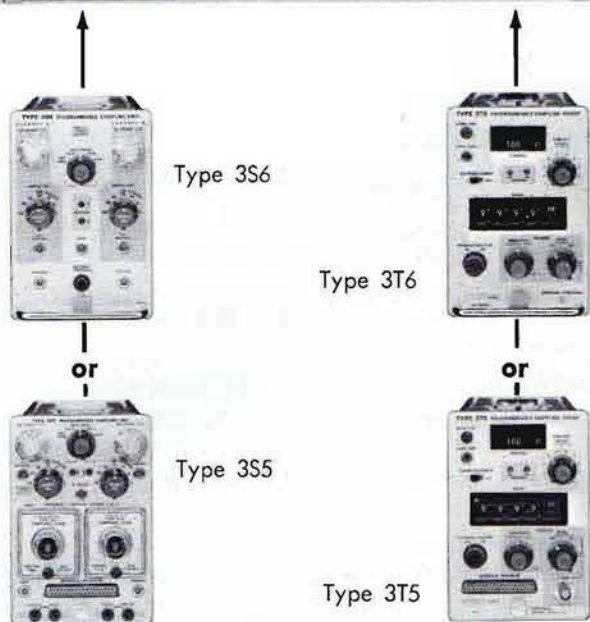

Type S-1
350 ps, 50 Ω



Type S-2
50 ps, 50 Ω



Type S-3
350 ps
100 kΩ, 2.3 pF



Type S-4
25 ps, 50 Ω



DIGITAL INSTRUMENTS AND SYSTEMS

IN YOUR SYSTEM

Tektronix digital instruments are designed for use in your automated measurement systems. Their modular construction lets you put together a complete measurement system designed to do your specific job.

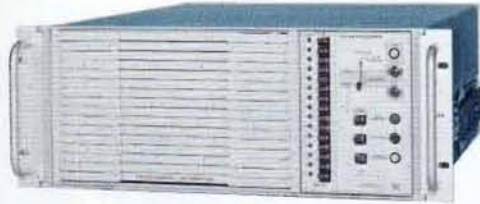

TYPE 241 PROGRAMMER provides up to 15 measurement programs for the Type 568/230. Programs can be manually or remotely selected. The Type 241 will automatically sequence through up to 15 programs, stopping on out-of-limits measurements. (page 32)



TYPE 240 PROGRAM CONTROL UNIT programs the Type 568/230 with up to 1600 measurement programs, stored in a Disc Memory or Punched Tape Reader. Additional units may be programmed by adding the Type R250 Auxiliary Unit. (page 36)



TYPE R250 PROGRAM AUXILIARY UNIT adds additional programming capabilities to the Type 240 and provides programming and buffering for pulse generators, power supplies and other equipment. Customer engineering and design is required with the Type R250. (page 40)

TEKTRONIX MEASUREMENT SYSTEMS

Tektronix Measurement Systems use Tektronix Catalog products and add additional equipment such as programmable pulse generators, programmable power supplies, fixtures, equipment racks and other equipment. Tektronix does the systems engineering and supplies a digital measurement system ready to do your measurement job.



TYPE S-3110 DIGITAL MEASUREMENT SYSTEM consists of the Type 568/230 with Type 241 Program Unit providing up to 15 automatic measurements. (page 34)



TYPE S-3130 DIGITAL MEASUREMENT SYSTEM consists of the Type 568/230/240 with the Type R250 Auxiliary Program Unit and a Disc Memory and Punched Tape Reader. It also includes a programmable pulse generator, 4 programmable power supplies and test fixtures. (page 44)



TYPE 3S5 PROGRAMMABLE SAMPLING UNIT

- PROGRAMMABLE VOLTS/DIV
- PROGRAMMABLE DC OFFSET
- PLUG-IN SAMPLING HEADS
- FRONT AND REAR PANEL PROGRAM CONNECTORS

The Type 3S5 Programmable Sampling Unit extends the automated measurement capabilities of the Type 567 or Type 568 Digital Readout Oscilloscopes by allowing remote programming of the vertical plug-in measurement functions. The Type 3S5 can also be used in the Type 561A and 564 Oscilloscopes where it may be operated manually from the front panel or externally programmed.

The Type 3S5 is a dual-trace programmable vertical unit featuring Sampling Heads that plug-in directly or are located remotely with the optional Sampling-Head extenders. Most of the measurement functions of the Type 3S5 are externally programmable through use of parallel multi-pin connectors on the front panel of the plug-in and the rear panel of the Type 568 Oscilloscope. Programmable functions include deflection factor, DC offset and smoothing.

Sampling Heads feature a choice of measurement capabilities and may be mixed or matched to meet specific measurement needs. A front panel control allows adjustment of the interchannel time relationship to compensate for signal cables or other external delays.

CHARACTERISTICS

SAMPLING HEADS

May be plugged into the Type 3S5 or located remotely on the optional 3-ft or 6-ft Sampling-Head extenders.

SAMPLING HEAD	RISETIME	INPUT	MINIMUM DEFLECTION FACTOR	RANDOM NOISE	PRICE
Type S-1	350 ps	50 Ω , GR874	2 mV/div	2 mV	
Type S-2	50 ps	50 Ω , GR874	2 mV/div	6 mV	
Type S-3	350 ps	2.3 pF, 100 k Ω	2 mV/div	3 mV	
Type S-4	25 ps	50 Ω , 3 mm	2 mV/div	10 mV	

DEFLECTION FACTOR

2 mV/div to 200 mV/div in 7 calibrated steps, 1-2-5 sequence. Each step accurate within 2% in normal mode, within 3% smoothed. Each channel may be programmed with 3 program lines or by manual front panel controls.

DC OFFSET RANGE

+1 V to -1 V. Allows signals between +1 V and -1 V limits to be displayed at 2 mV/div. Continuously variable and calibrated with front panel controls between +1 V and -1 V, accurate within 10 mV of same offset voltage obtained in the external program mode. Programmable between +995 mV and -995 mV in 5-mV steps. The programmable accuracy is within 2% or 5 mV (whichever is greater) of the programmed value. Programming is accomplished with 9 program lines per channel in BCD code plus one program line per channel for + or - polarity.

B-DELAY RANGE

Channel B display can be continuously positioned in time from +5 ns to -5 ns with respect to Channel A. Accommodates up to 3-foot difference in signal cable or Sampling-Head extenders.

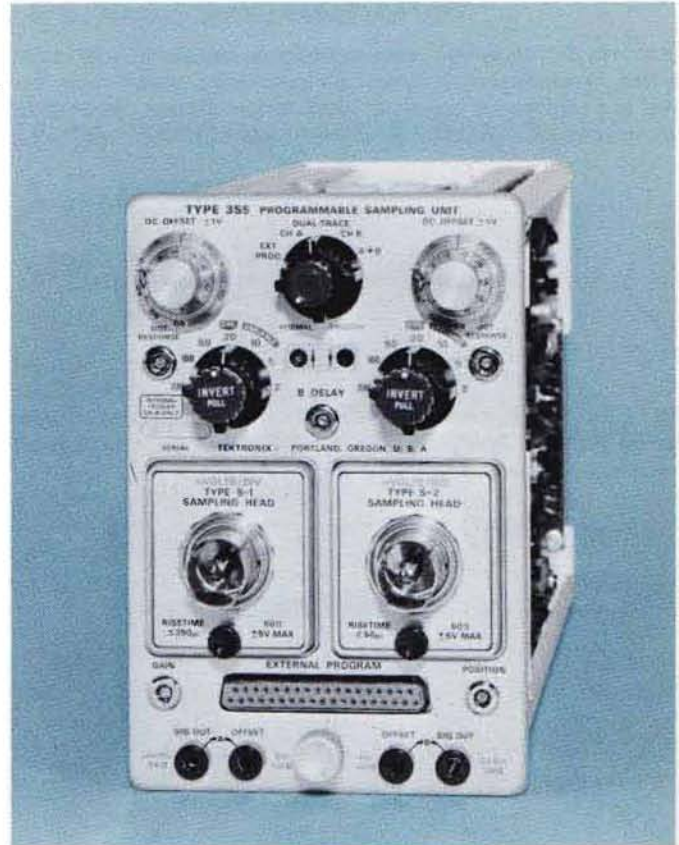

PROGRAMMING

The Type 3S5 uses negative logic with true being ground or < 2 V, and false being open or > 6 V. The units/div range is programmed with 3 lines per channel. DC offset is programmed with 9 lines per channel in BCD code plus one line per channel for + or - polarity. One line is used to program smoothed or normal operation. A total of 27 program lines is required to externally program all the measurement functions of the Type 3S5.

DISPLAY MODES

A only, B only, dual trace, algebraic addition of A and B signals. In the external program mode, dual-trace operation is automatically provided. Independent controls for each channel permit positioning and inverting displays as desired.

INCLUDED STANDARD ACCESSORIES

Connector (131-0422-00); connector cover (200-0660-00); circuit board connector (388-0805-00); two instruction manuals (070-0788-00).

OPTIONAL ACCESSORIES

- 3-ft Sampling-Head extender, order 012-0124-00
- 6-ft Sampling-Head extender, order 012-0125-00



TYPE 3S6 PROGRAMMABLE SAMPLING UNIT

- PROGRAMMABLE VOLTS/DIV
- PROGRAMMABLE DC OFFSET
- REMOTE SAMPLING HEADS
- ALL CONNECTIONS ON REAR PANEL

The Type 3S6 Programmable Sampling Unit is designed for use only in the Type 568 and Type R568 Digital Readout Oscilloscopes. The measurement functions of the Type 3S6 may be operated manually from the front panel or they may be controlled externally from connectors mounted on the rear panel of the Type 568 Oscilloscope. The Type 3S6 is designed primarily for use in automated measurement systems that require minimum front panel connections and remote programming of all vertical measurement functions. The programmable functions of the Type 3S6 are deflection factor, DC offset, and smoothing. Sampling Heads and program cables are attached to rear panel connectors on the Type 568 Oscilloscope.

Sampling Heads feature a choice of measurement capabilities and may be mixed or matched to meet specific measurements needs. A front panel control allows adjustment of the interchannel time relationship to compensate for signal cables or other external delays.

CHARACTERISTICS

SAMPLING HEADS

Located remotely on included 6-ft Sampling-Head extender that connects on the rear of the Type 568 Oscilloscope. Type 568 Oscilloscopes below serial number B110000 require a modification. Please consult your Field Engineer, Representative or Distributor.

SAMPLING HEAD	RISETIME	INPUT	MINIMUM DEFLECTION FACTOR	RANDOM NOISE	PRICE
Type S-1	350 ps	50 Ω, GR874	2 mV/div	2 mV	
Type S-2	50 ps	50 Ω, GR874	2 mV/div	6 mV	
Type S-3	350 ps	2.3 pF, 100 kΩ	2 mV/div	3 mV	
Type S-4	25 ps	50 Ω, 3 mm	2 mV/div	10 mV	

DEFLECTION FACTOR

2 mV/div to 200 mV/div in 7 calibrated steps, 1-2-5 sequence. Each step accurate within 2% in normal mode, within 3% smoothed. Each channel is programmed with 3 program lines or by manual front panel controls.

DC OFFSET RANGE

+1V to -1V. Allows signals between +1V and -1V limits to be displayed at 2 mV/div. Continuously variable and calibrated with front panel controls between +1V and -1V, accurate within 10 mV of same offset voltage obtained in the external program mode. Programmable between +995 mV and -995 mV in 5-mV steps. The programmable accuracy is within 2% or 5 mV (whichever is greater) of the programmed value. Programming is accomplished with 9 program lines per channel in BCD code, plus one program line per channel for + or - polarity.



B-DELAY RANGE

Channel B display can be continuously positioned in time from +5 ns to -5 ns with respect to Channel A. Accommodates up to 3-foot difference in signal cables.

PROGRAMMING

The Type 3S6 uses negative logic with true being ground or <2V and false being open or >6V. The units/div range is programmed with 3 lines per channel. DC offset is programmed with 9 lines per channel in BCD code plus one line per channel for + or - polarity. One line is used to program smoothed or normal operation. A total of 27 program lines is required to externally program all the measurement functions of the Type 3S6.

DISPLAY MODES

A only, B only, dual trace, and algebraic addition of A and B signals. In the external program mode, dual-trace operation is automatically provided. Independent controls for each channel permit positioning and inverting displays as desired.

INCLUDED STANDARD ACCESSORIES

6-ft Sampling-Head extender (012-0130-00); two circuit board connectors (388-0805-00); two instruction manuals (070-0789-00).



TYPE 3T5 PROGRAMMABLE SAMPLING SWEEP

- PROGRAMMABLE TIME/DIV
- PROGRAMMABLE SWEEP DELAY
- 100 ps/DIV to 500 ms/DIV CALIBRATED SWEEP RANGE
- FRONT AND REAR PANEL PROGRAM CONNECTORS

The Type 3T5 Programmable Sampling Sweep Unit extends the automatic measurement capabilities of the Type 567 or the Type 568 Digital Readout Oscilloscopes, by allowing remote programming of the sampling sweep unit. The Type 3T5 can also be used in the Type 561A and Type 564 Oscilloscopes where it may be operated manually from the front panel, or externally programmed with the front panel program connector.

The time/div range, delay time range and samples/sweep of the Type 3T5 are externally programmed by means of parallel multipin connectors located on the front panel of the Type 3T5 and the rear panel of the Type 568 Oscilloscope (Serial Number B110000 and above). Digital delay and real-time sampling (1 ms/div to 500 ms/div) are controlled by a clock and digital counter within the plug-in unit. An automatic trigger mode is provided to eliminate the need for trigger adjustments over a wide range of trigger amplitudes, repetition rates, risetimes and pulse widths.

CHARACTERISTICS

SWEEP TIME/DIV

Remotely programmable or front panel operation from 100 ps/div to 500 ms/div in 30 calibrated steps, 1-2-5 sequence. TIME/DIV "window" provides digital readout of all sweep time/div settings in both programmable and manual modes of operation. Programming is accomplished with 7 program lines. Accuracy is within 3%, except for non-linearities at the beginning of the sweep, that can be programmed off screen.

SAMPLES/SWEEP

1 sample/sweep or 1000 samples/sweep are available in the manual mode of operation; 1000 samples/sweep or 100 samples/sweep are available in the external programming mode of operation. In the external program modes, the Type 230 Digital Unit can program the sweep unit to scan quickly (100 samples/sweep) when not making a measurement, but provides maximum measurement resolution (1000 samples/sweep) when making the measurement. The Type 230 will also reset the sweep immediately after the completion of a measurement. These functions are obtained by externally programming the high speed program line on the Type 230.

DELAY RANGE

Digital delay is obtained with a clock and a digital counter within the Type 3T5. The digital delay is remotely programmable or selectable from the front panel. The delay range is from 0 to 999.9 ns in 100-ps increments from 100 ps/div to 500 ps/div; 0 to 9.999 μ s in 1-ns increments from 1 ns/div to 1 μ s/div; 0 to 999.9 μ s in 100-ns increments from 2 μ s/div to 500 μ s/div. Programming is accomplished with 16 program lines.



TRIGGERING

SOURCES: Internal, if sampling unit contains a trigger pick-off; External, 50- Ω terminated input.

JITTER: External automatic, pulse, 30 ps or less with 300-mV pulse, 2 ns or less wide; sinewave, 200 ps or less with 300-mV P-P signal at 30 MHz.

PULSE TRIGGERING

SOURCE	FREQUENCY	AMPLITUDE
Internal	DC to 100 MHz	100 mV to 2 V
External	DC to 100 MHz	5 mV to 250 mV
External Automatic	DC to 100 MHz	100 mV to 500 mV

SINEWAVE TRIGGERING

SOURCE	FREQUENCY	AMPLITUDE peak-to-peak
Internal	100 kHz to 100 MHz	100 mV to 2 V
External	1 Hz to 100 MHz	10 mV to 500 mV
External Sync	100 MHz to 1 GHz	10 mV to 500 mV
External Automatic	DC to 100 MHz	100 mV to 500 mV

INCLUDED STANDARD ACCESSORIES

5-ns, 50- Ω RG58 cable with BNC connectors (012-0057-01); 10X 50- Ω BNC attenuator (011-0059-00); GR-to-BNC female adapter (017-0063-00); GR-to-BNC male adapter (017-0064-00); electrical connector (131-0422-00); electrical connector cover (200-0660-00); circuit board connector (388-0805-00); two instruction manuals (070-0760-00).



TYPE 3T6 PROGRAMMABLE SAMPLING SWEEP

- PROGRAMMABLE TIME/DIV
- PROGRAMMABLE SWEEP DELAY
- 100 ps/DIV to 500 ms/DIV CALIBRATED SWEEP RANGE
- ALL CONNECTIONS ON REAR PANEL

The Type 3T6 Programmable Sampling Sweep Unit is designed for use only in the Type 568 and Type R568 Digital Readout Oscilloscopes. The measurement functions of the Type 3T6 may be operated manually from the front panel or they may be controlled externally from connectors mounted on the rear panel of the Type 568 Oscilloscope. The Type 3T6 is designed for use in automated measurement systems that require minimum front panel connections and remote programming of horizontal functions.

The time/div range, sweep delay range and sample per sweep of the Type 3T6 are externally programmable using negative logic, with true being ground and false being open. Digital sweep delay and real-time sampling (1 ms/div to 500 ms/div) are controlled by a clock and digital counter within the plug-in unit. An automatic trigger mode is provided to eliminate the need for trigger circuit adjustment over a wide range of pulse amplitudes, repetition rates, and pulse wave-shapes. Type 568 Oscilloscopes below the serial number B11-0000 require a modification for use with the Type 3T6. Please consult your Field Engineer, Representative, or Distributor.

CHARACTERISTICS

SWEEP TIME/DIV

Remotely programmable or front panel operation from 100 ps/div to 500 ms/div in 30 calibrated steps, 1-2-5 sequence. TIME/DIV "window" provides digital readout of all sweep time/div settings in both programmable and manual modes of operation. Programming is accomplished with 7 program lines. Accuracy is within 3%, except for non-linearities at the beginning of the sweep, that can be programmed off screen.

SAMPLES/SWEEP

1 sample/sweep or 1000 samples/sweep are available in the manual mode of operation; 1000 samples/sweep or 100 samples/sweep are available in the external programming mode of operation. In the external program modes, the Type 230 Digital Unit can program the sweep unit to scan quickly (100 samples/sweep) when not making a measurement, but provides maximum measurement resolution (1000 samples/sweep) when making the measurement. The Type 230 will also reset the sweep immediately after the completion of a measurement. These functions are obtained by externally programming the high speed program line on the Type 230.

DELAY RANGE

Digital delay is obtained with a clock and a digital counter within the Type 3T6. The digital delay is remotely programmable or selectable from the front panel. The delay range is from 0 to 999.9 ns in 100-ps increments from 100 ps/div to 500 ps/div; 0 to 9.999 μ s in 1-ns increments from 1 ns/div to 1 μ s/div; 0 to 999.9 μ s in 100-ns increments from 2 μ s/div to 500 μ s/div. Programming is accomplished with 16 program lines.



TRIGGERING

SOURCES: Internal, if sampling unit contains a trigger pickoff; External, 50- Ω terminated input.

JITTER: External automatic, pulse, 30 ps or less with 300-mV pulse, 2 ns or less wide; sinewave, 200 ps or less with with 300-mV P-P signal at 30 MHz.

PULSE TRIGGERING		
SOURCE	FREQUENCY	AMPLITUDE
Internal	DC to 100 MHz	100 mV to 2 V
External	DC to 100 MHz	5 mV to 250 mV
External Automatic	DC to 100 MHz	100 mV to 500 mV

SINEWAVE TRIGGERING		
SOURCE	FREQUENCY	AMPLITUDE peak-to-peak
Internal	100 kHz to 100 MHz	100 mV to 2 V
External	1 Hz to 100 MHz	10 mV to 500 mV
External Sync	100 MHz to 1 GHz	10 mV to 500 mV
External Automatic	DC to 100 MHz	100 mV to 500 mV

INCLUDED STANDARD ACCESSORIES

Circuit board connector (388-0805-00); two instruction manuals (070-0761-00).



TYPE $\frac{241}{R241}$ PROGRAMMER



- **PROGRAMS TYPE 568/230 DIGITAL OSCILLOSCOPE**
- **UP TO 15 MEASUREMENTS**
- **MANUAL OR REMOTE SELECTION**
- **AUTOMATIC OR MANUAL SEQUENCE**
- **AUTOMATIC STOP SEQUENCE**
ABOVE UPPER LIMITS
WITHIN LIMITS
BELOW LOWER LIMITS
- **14 ADDITIONAL PROGRAM LINES**

The Type 241 Program Unit is designed for use with the Type 568 Oscilloscope, Type 3T5 or 3T6, Type 3S5 or 3S6 Programmable Plug-In Units, and the Type 230 Digital Unit. The Type 241 programs all the programmable functions of the Type 568/230 and has an additional 14 lines available for programming other equipment.

The Type 241 provides up to 15 programmed measurements that can be selected manually by front panel push buttons or by external control lines. Automatic or manual sequence of up to 15 measurements is provided with front panel or external control. In the automatic sequence mode, out-of-limit conditions can stop the measurement sequence if desired.

Each program board controls one measurement and has 159-bit capacity, enough to control the Type 568/230 with the Type 3T5 or 3T6 and Type 3S5 or 3S6 Programmable Plug-In Units and an additional 14 bits for external equipment.

Programs are easy to setup. A special tool is supplied to make insertion and removal of diodes quick and easy. Diode clips are labeled to permit a person having minimum training to program the boards. Typically only 15 to 20 diodes need to be inserted for a particular measurement.

The Type 241 program boards are accessible from the front panel and may be easily removed, rearranged or exchanged with others that are intended for different tests. A storage area in the rear of the Type 241 provides storage for up to 15 additional program boards. A storage drawer holds extra diodes and the diode inserting tool.

OPERATING MODES

SINGLE TEST MODE

Any program board/measurement can be selected in any order by a row of numbered push buttons on the front panel. 15 external control lines permit external selection of any measurement in any order by an external ground closure.

MANUAL SEQUENCE MODE

Up to 15 measurements may be stepped through manually with the front panel ADVANCE push button or by an external ground closure. Less than 15 measurements can be manually sequenced without including the undesired tests.

AUTOMATIC SEQUENCE MODE

In the automatic sequence mode up to 15 measurements can be sequenced through at a rate in excess of 100 measurements per second. Measurement limits may be programmed and out-of-limit conditions can stop the measurement sequence if desired. Limit lights on the front panel indicate the status of each test, and the condition which may have interrupted the automatic sequence. The ADVANCE button will advance the Type 241 to the next measurement in the sequence. The RESET button will reset the Type 241 to a ready condition. Both of these functions can be controlled externally by a ground closure. Less than 15 measurements can be automatically sequenced without including the undesired tests.

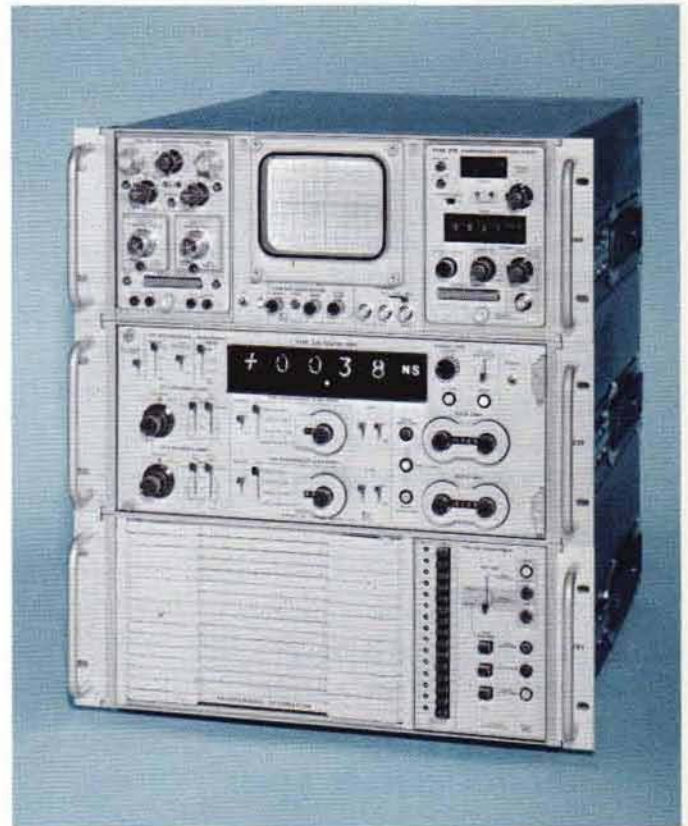

OTHER CHARACTERISTICS

POWER REQUIREMENTS

The power required to operate the Type 241 is obtained from the Type 230 Digital Unit.

TYPE 241 DIMENSIONS

Height	8 in	20.3 cm
Width	16 ³ / ₄ in	42.7 cm
Depth	21 ⁷ / ₈ in	55.5 cm

TYPE R241 DIMENSIONS

Height	7 in	17.8 cm
Width	19 in	48.3 cm
Depth	22 ³ / ₄ in	57.8 cm

INCLUDED STANDARD ACCESSORIES

15 program boards (670-0285-00); 6 interconnecting cables (012-0131-00); 450 diodes (152-0143-03); diode insertion tool (003-0611-00); 2 instruction manuals (070-0809-00).

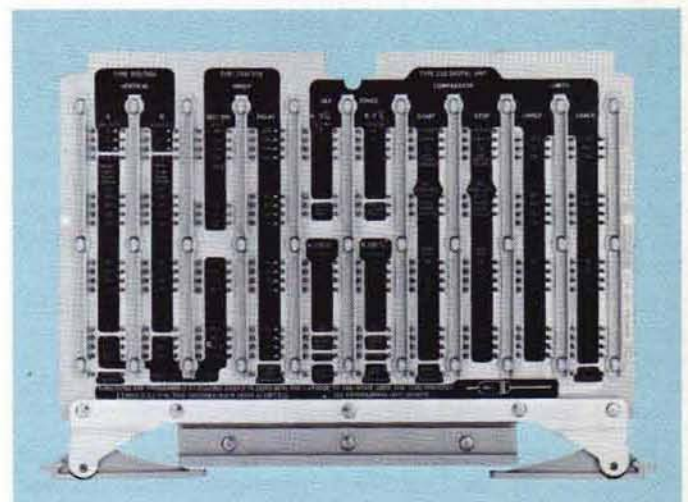

OPTIONAL ACCESSORIES

PROGRAM BOARDS

Up to 15 additional program boards may be stored in the rear of the Type 241. Program boards may be easily removed, rearranged or exchanged with others that are intended for different tests, order 670-0285-00



TYPE S-3110 DIGITAL MEASUREMENT SYSTEM

- **DYNAMIC MEASUREMENTS**
 - PULSE RISETIME AND FALLTIME**
 - PULSE WIDTH AND PERIOD**
 - PROPAGATION DELAY AND STORAGE TIME**
 - PULSE AMPLITUDE AND SATURATION VOLTAGE**
 - MANY OTHER SPECIFIC MEASUREMENTS**
- **AUTOMATIC MEASUREMENT SEQUENCE**
 - UP TO 15 MEASUREMENTS**
 - AUTOMATIC STOP SEQUENCE**
- **GO/NO-GO TESTING**
- **400-ps RISETIME**
- **100 ps/DIV to 500 ms/DIV**
 - CALIBRATED SWEEP RANGE**
- **20 mV/DIV to 2 V/DIV**
 - CALIBRATED VOLTAGE RANGE**

The Type S-3110 Digital Measurement System is a dynamic measurement system intended for measuring the performance of active devices under simulated operating conditions. It is designed to test integrated circuits, transistors, diodes, circuit modules, circuit boards and sub-assemblies in all segments of the electronic industry. The Type S-3110 can sequence through up to 15 measurements at a rate of 100 measurements per second. High and low measurement limits may be programmed and the Type S-3110 will stop on any combination of limits (high, go, low) if desired. A foot switch permits remote operation of the Type S-3110's advance and reset program functions.

The Type S-3110 features up to 15 measurement programs. Each measurement program has a card that is easily programmed by inserting diodes between the proper clips. Typically 15 to 20 diodes will provide the necessary program conditions. They are inserted with an easy-to-use tool.

The following instruments comprise the Type S-3110: Type R568 Oscilloscope with the Type 3T6 Programmable Sampling Sweep and Type 3S6 Programmable Sampling Unit, two Type S-3 Sampling Heads, Type R241 Programmer, 33³/₈-inch high equipment rack, a drawer, a foot switch, a utility panel and two probe choppers. The utility panel provides mounting for the Type S-3 Sampling Heads, a trigger input connector, power supply output connectors, pulse generator output and trigger input connectors, and a program connector that has 14 program lines available for programming peripheral equipment plus the necessary lines for operating the probe choppers.

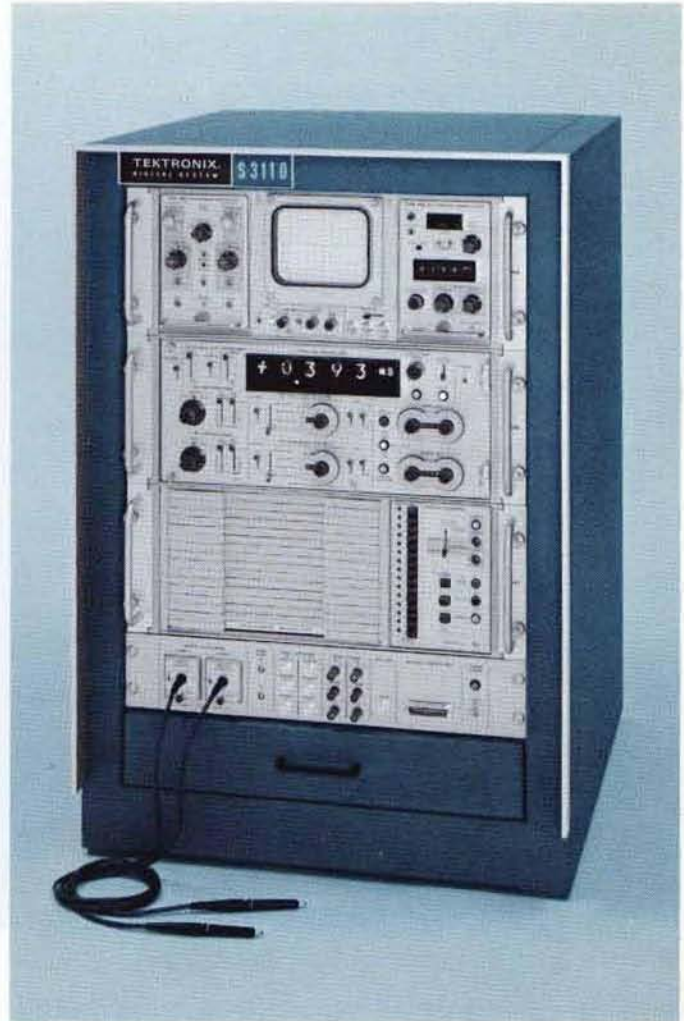

CHARACTERISTICS

VERTICAL AMPLIFIER

The included 10X or 100X probe attenuators must be used with the included probe choppers. Vertical characteristics are stated with the 10X attenuator.

Voltage measurements are from 20 mV/div to 2 V/div (8 div full scale) accurate within 3%.

Bandwidth is equivalent to DC to 875 MHz.

Risetime is less than or equal to 400 ps.

Input characteristics are 1 M Ω paralleled by 2 pF.

Programmable DC offset is from +9.95 V to -9.95 V in 50-mV steps.

TYPE S-3110

TIME BASE

Programmable sweep time/div is from 100 ps/div to 0.5 s/div in 30 calibrated steps, accurate within 3%.

Programmable digital delay range is from 0 to 999.9 μ s in increments of 100 ps, 1 ns or 100 ns, depending on the sweep time/div.

Automatic triggering eliminates the need for trigger adjustments over a wide range of trigger amplitudes, shapes and repetition rates. Automatically triggers on signals of 100 mV to 500 mV amplitude over a frequency range from DC to 100 MHz.

DIGITAL UNIT

Units of measure are read out in V, mV, ns, μ s, ms, s.

Numerical readout is from -3999 to +3999.

Programmable measurement limits are from -3999 to +3999.

Data output is in parallel BCD code, 29 lines, (1, 2, 4, 8; true = ground, false = +12 V).

PROGRAMMER

Programs up to 15 measurements. Test modes include automatic sequence of up to 15 measurements, manual or external program sequence through 15 measurements or single measurement operation. Out-of-limits measurements can stop the automatic sequence if desired. Each program has one program card with 159 bits that are selected by inserting diodes between the proper clips. Typically 15 to 20 diodes will provide the necessary program conditions. A foot switch provides remote operation of the Programmers advance and reset functions.

DISPLAY UNIT

CRT display is 8 x 10 cm with P31 phosphor.

Calibrator provides 20 kHz accurate within 0.05%, and approximately 1-kHz signals; amplitudes of 0.5 V and 5 V P-P within 2% into ≥ 100 -k Ω load, or 50 mV and 500 mV P-P within 2% into a 1% 50- Ω load.

INPUT-OUTPUT PANEL

The input-output panel of the Type S-3110 provides in one convenient location the input and output facilities of the system. The panel is 3 1/2 inches high and provides the following facilities: mountings for 2 Sampling Heads; 2 probe power connections for FET probes (room is available for mounting probe power supplies inside); 2 sets of pulse generator trigger and output connectors; 2 sets of power supply output connectors; Type 3T6 trigger input; a 36-pin connector which provides probe-chopper drive lines and 14 program lines for peripheral equipment; and a system master power switch and pilot light.

POWER REQUIREMENTS

105 V to 125 V or 180 V to 272 V, 48 Hz to 66 Hz, 340 watts at 115 V and 60 Hz. Rear panel selector on each instrument provides rapid accommodations for six line-voltage ranges.

DIMENSIONS

The Type S-3110 is 33 3/8 inches high, 23 inches wide and 25 1/2 inches deep. Instruments are mounted on slide-out tracks and individually can be pulled out, tilted and locked in any one of seven positions for convenient access.

Includes: Type R568 Oscilloscope; Type 3T6 Programmable Sampling Sweep; Type 3S6 Programmable Sampling Unit; two Type S-3 Sampling Heads; Type R230 Digital Unit; Type R241 Program Unit; equipment rack and storage drawer; two probe choppers; foot switch; utility panel; and includes the standard accessories of the above instruments.

TYPE S-3111

The Type S-3111 is identical to the standard Type S-3110 with the exception that a pulse generator and power supply are added, and supplied in a 42-inch high equipment rack. The pulse generator is a Tektronix Type 115 MOD 814R, mounted in a rack adapter that permits adding another pulse generator at a later date. The power supply is a Power Designs, Inc. Model 2005 mounted in a rack adapter that permits adding another supply at a later date.

The Tektronix Type 115 MOD 814R features output connectors on the rear panel, 10-ns to 100- μ s separate and variable rise-times and falltimes, 100-ns to 10-ms pulse periods, 50-ns to 500- μ s pulse delay or burst time, 50-ns to 500- μ s pulse width, +5 V to -5 V DC offset and up to ± 10 V amplitude into 50 Ω . See page 18 for further information.

The Power Designs, Inc. Model 2005 Precision Power Source features a digitally-selected operating range from 0 to 20 V, 0 to 500 mA; accuracy is within 0.1% ± 1 mV; load and line regulation is less than 0.0005% or 100 μ V; noise and ripple is less than 100 μ V, P-P; and stability is less than 100 μ V drift per 8 hours.

The Type S-3110 and S-3111 Digital Measurement Systems are available with different Sampling Heads featuring up to 25-ps risetimes, and data recording options. Consult your Field Engineer, Representative or Distributor for further information.



TYPE **240** **R240** PROGRAM CONTROL UNIT

- **CONTROLS TYPE 568 OSCILLOSCOPE AND TYPE 230 DIGITAL UNIT**
- **PROGRAM BRANCHING FOR DIAGNOSTIC TESTING**
- **SERIAL TO PARALLEL CONVERTOR**
- **PROGRAM PREPARATION, MODIFICATION AND VERIFICATION**
- **PROGRAM STORAGE**
 - Disc Memory Option*
 - Punched Tape Reader Option*
- **FIXED WORD LENGTH**
 - 48 4-bit Characters*
- **EXPANDABLE WITH TYPE 250**
 - 192 or 384 Additional Program Lines*

The Type 240 and Type R240 Program Control Units are designed to provide automated measurements utilizing the Type 568 Oscilloscope with the Type 3T5 or 3T6 and 3S5 or 3S6 Programmable Plug-In Units and the Type 230 Digital Unit. The Type 240 accepts program data serial-by-bit from the optional Disc Memory, serial-by-character from an optional Punched Tape Reader or from an external source. Programs may be originated or modified manually from the front panel of the Type 240. If other equipment needs to be externally programmed, a Type R250 Auxiliary Program Unit may be added to the Type 240.

Measurement rates in excess of 100 measurements per second are achieved using a Disc Memory. Sorting, classifying and diagnostic test routines are obtained using the Disc Memory. The Disc Memory also permits random access to a library of up to 1600 independent measurements. This feature permits a computer or other control device to have complete control over the test measurements, making calculations from the test data and using the Disc Memory for further measurements and sorting at the maximum test rates.

The Punched Tape Reader provides a maximum measurement rate of 6 measurements per second and is used in low-speed measurement systems. The Disc Memory can be added later to achieve maximum measurement rates and a library of 1600 measurement programs. The Punched Tape Reader is also used for loading measurement programs into the Disc Memory. The Type 240 may be used without the Disc Memory or Punched Tape Reader by providing program data externally in a serial-by-character form, asynchronously at up to 600-kHz character rate. Data sources include paper or magnetic Tape Readers and computer data output.

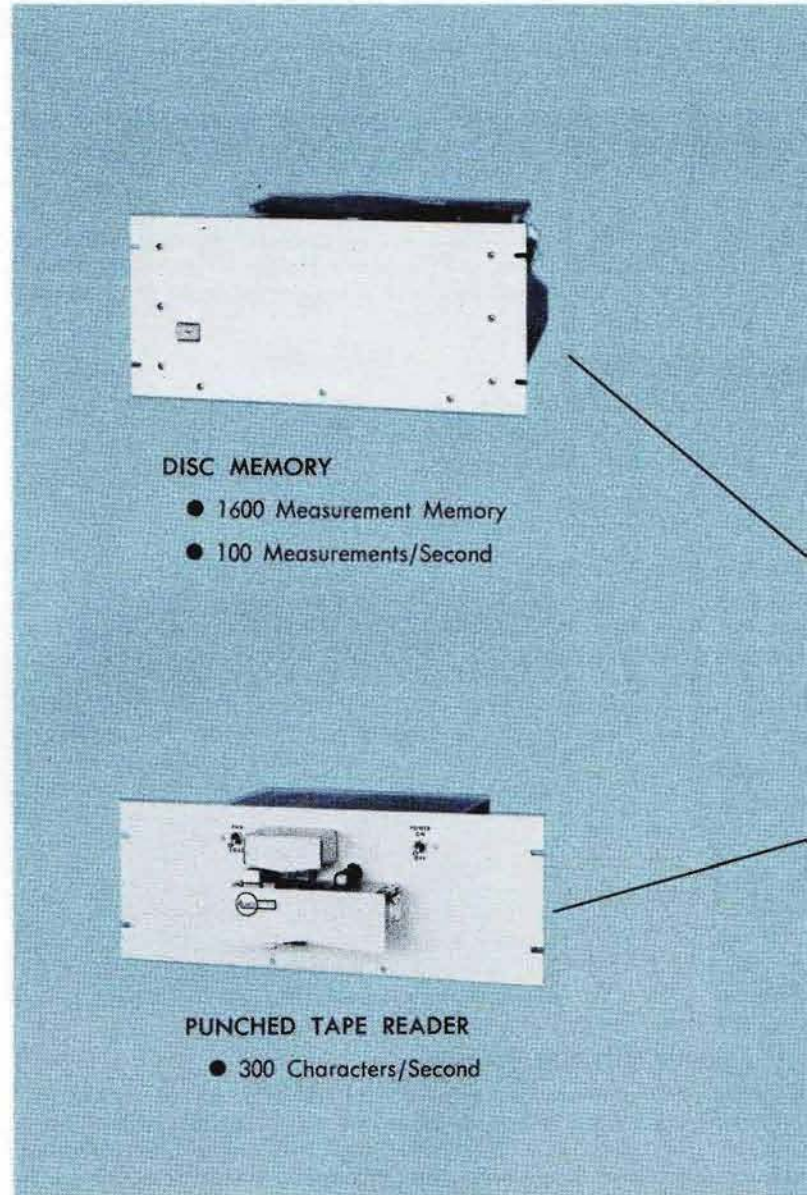

DISC MEMORY

- 1600 Measurement Memory
- 100 Measurements/Second

PUNCHED TAPE READER

- 300 Characters/Second

The Type 240 has a fixed word length of 48 4-bit characters that normally are used to program the measurement address, Type 568 Oscilloscope with the Type 3T5 or 3T6 and 3S5 or 3S6 Programmable Plug-In Units, and the Type 230 Digital Unit. The 192 program lines use negative logic, with true being a saturated NPN transistor to ground and false being an open collector. The Type 240 Program can also be used to program other equipment.

The Type R250 Auxiliary Program Unit expands the programming capabilities of the Type 240, permitting programming of pulse generators, power supplies, test fixtures, automatic handlers, and other devices required for automated measurement systems. The Type R250 provides program buffering, digital-to-analog conversion and patch panel capabilities. One Type R250 provides an additional 192 program lines; two Type R250's provide 384 program lines.

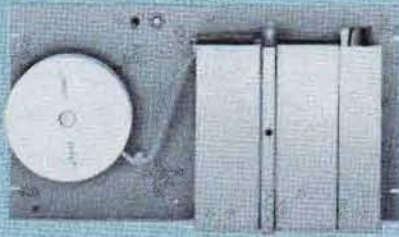

TAPE PUNCH

● 60 Characters/Second

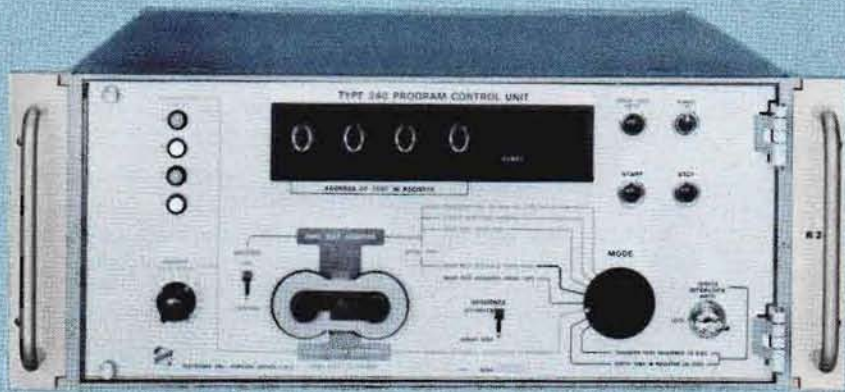

TYPE 240 PROGRAM CONTROL UNIT

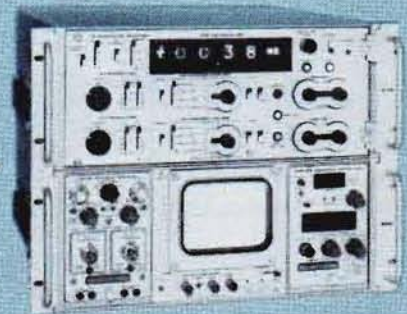

TYPE 568/230 DIGITAL OSCILLOSCOPE

- Voltage Measurements
- Time Measurements



TYPE R250 AUXILIARY PROGRAM UNIT

● 192 Additional Program Lines

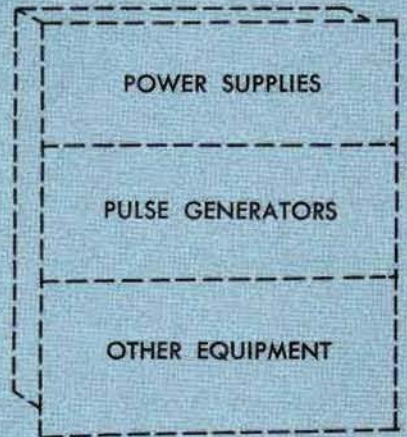

TYPE **240** **R240**

OPERATING MODES

The Type 240 has eight operating modes that are selected by the front panel mode switch. It will perform any of the eight functions after receiving the start command from an external source or the front panel. The functions are as follows:

TRANSFER TEST ON DISC TO TAPE

This function loads the shift registers of the Type 240 with program data from the Disc Memory as selected by the disc test address. When the register is full, the program data is shifted out of the register to the Tape Punch. When the Tape Punch has punched a complete program tape, the Type 240 is returned to a ready condition.

LOCATE NEXT DISC ADDRESS

This function locates the next disc address after a complete measurement has been made. Measurement programs on the disc are spaced to achieve minimum program access time, providing measurement rates in excess of 100 measurements per second.

READ TEST FROM DISC

This function loads the register with program data from the disc sector selected and tells the Type 568/230 to make the measurement. At the end of the measurement, the Type 240 returns to the ready condition.

READ TEST SEQUENCE FROM DISC

This function loads the shift register with program data from the disc sector selected and tells the Type 568/230 to make the measurement. At the end of the measurement, a print command from the Type 230 loads the shift register with data from the disc sector selected by the next program test address. In the automatic sequence mode, this sequence continues until the Type 240 receives a stop signal and returns to the ready condition.

In this mode of operation the Type 240 can be programmed to branch to a new measurement sequence and stop the sequence on out-of-limits measurements. For example when making a risetime measurement, a within-limits measurement would continue the normal measurement sequence; an above-limit measurement (slow risetime) can stop the sequence to reject the component, and a below-limit measurement (fast risetime) can branch to a new measurement sequence for reclassifying the component. Out-of-limit measurements are normally programmed to repeat, to check for possible measurement error.

READ TEST SEQUENCE FROM TAPE

This function loads the shift register data from the Punched Tape Reader, tells the Type 230 to make a measurement, and continues making measurements until the Type 240 receives a stop signal. The Punched Tape Reader can program the Type 240 to stop the measurement sequence on out-of-limit measurements. Out-of-limit measurements are normally programmed to repeat, to check for possible measurement error.

EXAMINE OR MODIFY CHARACTERS IN REGISTER

This function displays on the character data lights the data that is in the shift register. Characters are selected by the character address switches and the characters can be modified with the use of the new data switch and the modify pushbutton.

WRITE TEST IN REGISTER ON DISC

This function permits new or modified program data in the register to be written on the disc sector selected. A write inner-lock key prevents accidental writing and changing of data that is already written on the Disc Memory.

TRANSFER TAPE SEQUENCE TO DISC

This function loads the Type 240 shift register with new program data from the Punched Tape Reader and writes the program data on the disc sector selected. The write inner-lock key must be turned on and prevents accidental writing on the Disc Memory.

PROGRAM INPUTS

The Type 240 program inputs are in one of two forms: either serial by 4-bit character plus parity at up to 600-kHz character rate, or the Disc Memory input is serial by bit (4 bits plus parity per character) at a 3-MHz bit rate. The optional Disc Memory and Punched Tape Reader are designed specifically for use with the Type 240. The optional Disc Memory provides a storage capacity of 1600 measurements for the Type 240/250 Measurement System (1024 complete measurements for a Type 240/250/250 Measurement System). The program access time for the Disc Memory is 17 ms average and can be optimized to approximately 1 ms through the use of minimum access time programming. The optional Punched Tape Reader provides a maximum speed of 300 characters per second and is used in low-speed measurement systems and for loading programs into the Disc Memory. Other data sources could be used, including magnetic tape readers and computers.

DISC TEST ADDRESS

The disc test address can be selected manually from the front panel or can be controlled externally by a computer or other control device. This permits random access to the Disc Memory's library of up to 1600 independent measurements. For external control of the disc test address, 12 program lines are required with negative logic (true = 0 V to +2 V, false = +6 V to +12 V) plus one external enable line.

PROGRAM LINE OUTPUTS

The Type 240 has 192 program lines that are normally used to program the Type 568 Oscilloscope with the Type 3T5 or 3T6 and 3S5 and 3S6 Programmable Plug-In Units, and the Type 230 Digital Unit. These lines can be used to program other equipment when the Type 568 and Type 230 are not used. The 192 program lines feature negative logic, with true being a saturated NPN transistor to ground and false being an open collector. Space is available on the program boards for special circuitry such as logic level conversion, logical inversion, gating, etc.

OTHER CHARACTERISTICS

POWER REQUIREMENTS

90 V to 136 V or 180 V to 272 V, 50 to 60 Hz, 194 watts at 115 V and 60 Hz. Rear panel selector provides rapid accommodation for 6 line-voltage ranges.

TYPE 240 DIMENSIONS AND WEIGHT

Height	8 in	20.3 cm
Width	16 ³ / ₄ in	42.7 cm
Depth	21 ⁷ / ₈ in	55.5 cm
Net weight	41 lb	18.6 kg

TYPE R240 DIMENSIONS AND WEIGHT

Height	7 in	17.8 cm
Width	19 in	48.3 cm
Depth	22 ³ / ₄ in	57.8 cm
Net weight	44 lb	20 kg

INCLUDED STANDARD ACCESSORIES

Type 240 only adapter (013-0095-00); Punched Tape Reader only adapter (013-0096-00); 5 36-pin cables with labels (012-0131-00); 36-pin cable with label (012-0131-01); Type 240 program format table tablet (070-0884-00); 2 instruction manuals (070-0749-00). Type R240 also includes mounting tracks (351-0085-00) and mounting hardware.

OPTIONAL ACCESSORIES

DISC MEMORY

Disc Memory is an 8-track rotation Disc Memory capable of storing 200 measurements per track or a total of 1600 measurements when used with the Type 240 or 240/250 Program Units (1024 measurements with the Type 240/250/250). The format for any test is made up of a fixed word length of 96 characters of 4 bits each plus parity (144 characters with Type 240/250/250). The Disc Memory is 8¾ inches high, 19 inches wide and 19¾ inches deep with a total weight of 62 lb. The instrument is factory wired for 108-V to 132-V operation, 190 watts, 60 Hz. The Disc Memory is made by Data Disc, Inc. especially for Tektronix.

Disc Memory, order 020-0024-00

Disc Memory for Type 240/250/250 System, order 020-0025-00

Includes: extender card (012-0151-00); Type 240 to Disc Memory cable (012-0133-01).



PUNCHED TAPE READER

The Punched Tape Reader is designed for use with the Type 240 for programming the Type 568/230 Digital Oscilloscope System or for loading programs into the Disc Memory. Programs may be generated on the Tape Punch or any standard ASCII tape punch. The Punched Tape Reader has a maximum speed of 300 characters per second. Measurement programs are fixed word length and require 48 4-bit characters plus parity when using the Type 240, 96 4-bit characters plus parity when using a Type 240/250, and 144 4-bit characters plus parity when using a Type 240/250/250 Measurement System. The Punched Tape Reader is 7 inches high, 19 inches wide, 7¾ inches deep and weighs 26 lb. Power requirements are 95 V to 130 V, 150 watts, 60 Hz. The Punched Tape Reader is made by Remex Electronics, Inc. especially for Tektronix.

Punched Tape Reader, order 020-0026-00

Includes: Type 240 to Punched Tape Reader cable (012-0147-00).

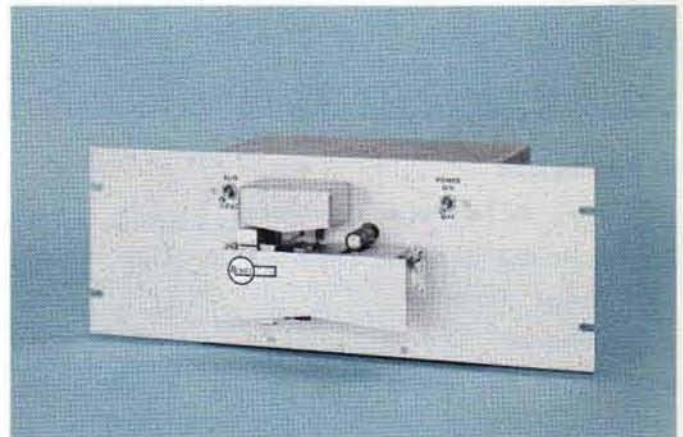

TAPE PUNCH

The Tape Punch is designed to be used with the Type 240 Program Control Unit, and is used for generating new program tapes from the Type 240. Programs stored in the Disc Memory may be transferred via the Type 240 to the Tape Punch for permanent storage. The Tape Punch has a maximum speed of 60 characters per second. It is 10½ inches high, 19 inches wide, 12¾ inches deep and weighs 38 lb. The tape Punch is factory wired for 105-V to 125-V operation, 320 watts, 60 Hz. The perforator mechanism is made by Tally, Inc. especially for Tektronix.

Tape Punch, order 020-0027-00

Includes: Type 240 to Punched Tape Reader/Tape Punch cable (012-0146-00).

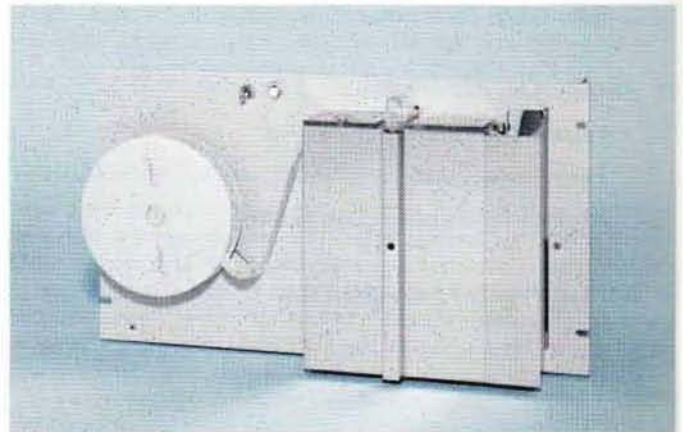



TYPE **R250** AUXILIARY PROGRAM UNIT

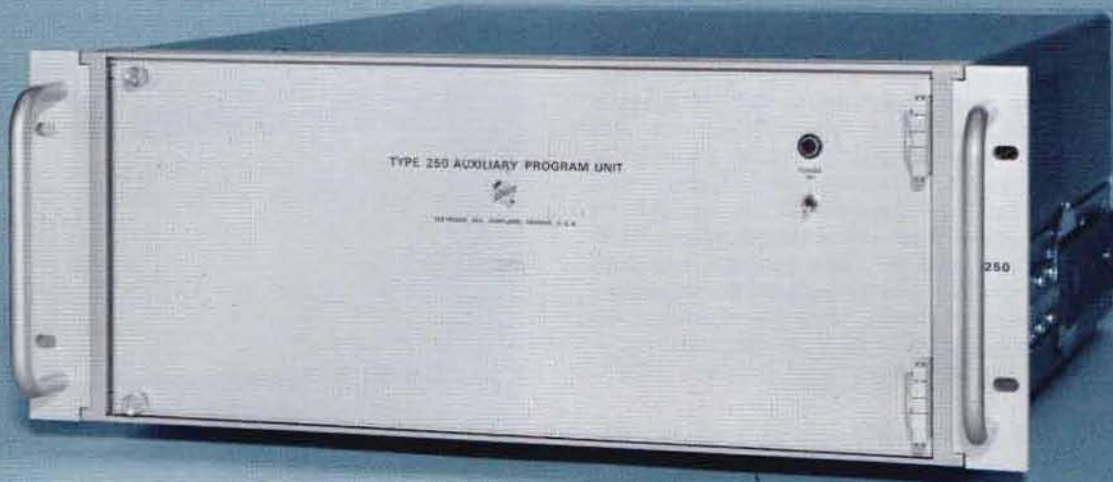

- **PROGRAMS**

- Type R116 Pulse Generator**

- Type R293 Pulse Generator**

- Power Supplies**

- Fixtures**

- Other Equipment**

- **192 PROGRAM LINES**

- 48 4-bit Characters**

- **PROGRAM BUFFERING**

- Level Conversion**

- Level Inversion**

- Digital-To-Analog Conversion**

- **PATCH-PANEL CAPABILITIES**

The Type R250 Auxiliary Program Unit is designed for use with the Type 240 Program Control Unit and permits external programming of additional equipment such as power supplies, pulse generators and fixtures. The Type R250 is a system component. The customer needs to do systems engineering and intra-connection wiring for operation. The Type R250 requires 12 program assembly cards for operation.

Up to two Type R250's may be used with the Type 240, providing an additional 192 program lines per Type R250. The Type R250 has 48 4-bit characters with 192 program lines. It features program buffering, digital-to-analog conversion and patch panel capabilities.

Systems engineering is required with the shift register cards and the program boards. The customer must determine the proper interface required from the Type R250 to the auxiliary equipment to be programmed. Then two program boards are selected and wired to each shift register card to obtain the necessary program functions. Three program boards are available offering the following functions: standard program boards with negative logic programming, resistance program boards, and conductance program boards.

Two Tektronix programmable pulse generators are available and listed under optional equipment. They come complete with the program assembly cards and cables necessary for use with the Type R250.

TYPE R250

POWER REQUIREMENTS

90 V to 136 V or 180 V to 272 V, 50 to 60 Hz, 194 watts at 115 V and 60 Hz. Rear panel selector provides rapid accommodation for 6 line-voltage ranges.

TYPE R250 DIMENSIONS AND WEIGHT

Height	7 in	17.8 cm
Width	19 in	48.3 cm
Depth	22 ³ / ₄ in	57.8 cm
Net weight	41 ¹ / ₂ lb	18.8 kg

INCLUDED STANDARD ACCESSORIES

Type 240 to Type R250 interconnecting cable (012-0134-00)*; program format table (070-0886-00); two instruction manuals (070-0748-00).

TYPE R250 AUXILIARY PROGRAM UNIT requires 12 Program Assembly Cards

*If two Type R250's are to be used, indicate on your order that you need a 240/R250/R250 cable (012-0135-00) rather than a 240/R250 cable (012-0134-00).

REQUIRED PROGRAM ACCESSORIES

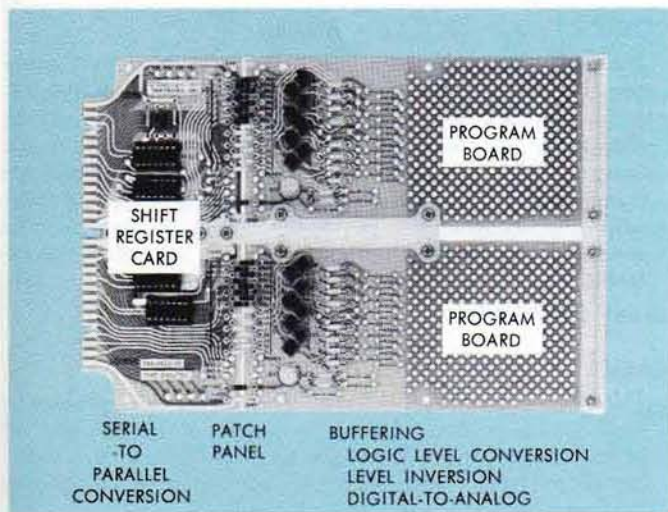

PROGRAM ASSEMBLY CARDS

Twelve program assembly cards are required for operation of the Type R250. Each program assembly card consists of one shift register card that does the serial-to-parallel conversion, and two program boards that provide program buffering. Wiring between the shift register card and the program boards is required. Interwiring connections provide patch-panel capabilities. Two Tektronix Programmable Pulse Generators are available with program assembly cards necessary for programming their functions.

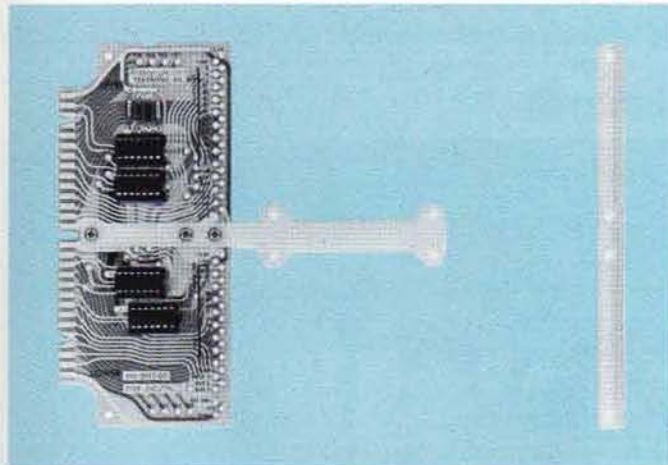

SHIFT REGISTER CARD

12 shift register cards are required for the operation of the Type R250. Each card contains a 4-character, 4-bit shift register providing a total of 16 bits for programming. The normal connection from the shift register is 8 bits to the upper program board and 8 bits to the lower program board. Two program boards are required with each shift register card. The program boards may be of the same or different types. The shift register card provides the following connections: 16 program lines to an associated rear panel connector, 8 lines to an adjacent program board on the right, and 8 lines to an adjacent program board on the left.

Order 020-0020-00

STANDARD PROGRAM BOARD

The standard program board contains separate buffer amplifiers for 8 program lines and has provisions for adding isolation diodes and RC delay networks for each program line. The standard program board must be mounted on the shift register card, and inter-wiring connections must be made. The board provides negative logic with true being a saturated NPN transistor to ground, and false being an open collector. Space is available on the board for special circuitry, such as logic level conversion, logical inversion gating, etc.

Order 020-0021-00

please turn page for additional information

TYPE R250

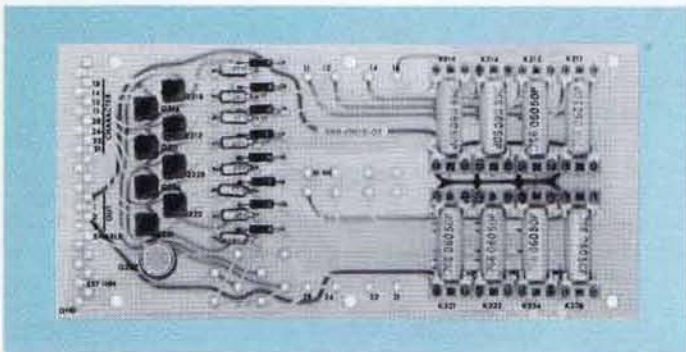
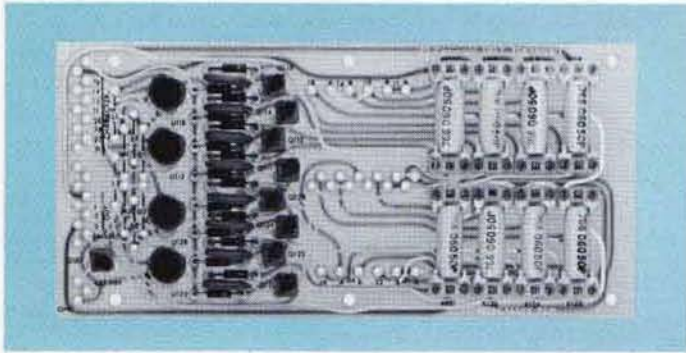

RESISTANCE PROGRAM BOARD

The resistance program board includes buffer drivers, amplifiers, and reed relay switches and coils for switching 8 resistors in a series of resistive networks. Eight program bits from the shift register provide 2 decades of resistance changes (1% increments) for programming analog functions. The resistance program board provides digital-to-analog conversion necessary for programming analog equipment. The resistance program board must be mounted on the shift register card, and inter-wiring connections must be made. Proper resistors must be wired on the board to program the steps desired in the external equipment.

Order 020-0023-00

CONDUCTANCE PROGRAM BOARD

The conductance program board is similar to the resistance board, except that 8 resistors are switched in a parallel resistance network. This gives 100 increments of conductance change for programming analog conversions which require linear change of conductance. The conductance program board must be mounted on the shift register card, and inter-wiring connections must be made. Proper resistors must be wired on the board to program the steps desired in the external equipment.

Order 020-0022-00

CABLES

The 192 program lines of the Type R250 are available on seven 36-pin connectors on the rear panel. Cables are required to connect the Type R250 to the programmable instruments. Interconnecting cables are included with the optional Tektronix programmable equipment.

6-ft shielded interconnecting cable with 36-pin connector on both ends, order 012-0131-00

8-ft shielded interconnecting cable with 36-pin connector on one end, no connector on other end, order 012-0132-00

OPTIONAL EQUIPMENT



TYPE R116 MOD 703L

The Type R116 MOD 703L Programmable Pulse Generator is a modified Tektronix Type R116 Programmable Pulse Generator furnished with 5 Program Assembly Cards and interconnecting

cables necessary for the Type R250. Program assembly cards program the Type R116 and are calibrated to the Type R116. The input and output connectors of the Type R116 are moved to the rear panel.

TYPE R250

PROGRAMMING BITS required for all range and incremental programming plus mode, trigger source and polarity programming is 79. If all functions do not require programming, one or more of the programming assembly boards need not be used. Front panel controls are accurate within the indicated tolerances plus an additional 2%.

PULSE PERIOD is programmed in 5 decade ranges (100 ns, 1 μ s, 10 μ s, 100 μ s, 1 ms). Each range can be programmed from X1.0 to X10.9 in 0.1 incremental steps. Accurate within 5% on 100-ns range, within 3% on all other ranges.

PULSE DELAY/BURST is programmed in 4 decade ranges (10 ns, 100 ns, 1 μ s, 10 μ s) with each range programmed from X5.0 to X54.5 in 0.5 incremental steps. Accurate within (3% + 10 ns).

PULSE RISETIME AND PULSE FALLTIME are programmed from 10 ns to 109 μ s. The risetime and falltime is the result of $(t_r/t_f \text{ range}) \times (t_r \text{ or } t_f \text{ multiplier}) \times (\text{amplitude multiplier})$. Range is programmed in 4 decade steps (1 ns, 10 ns, 100 ns, 1 μ s). Rise-time and falltime multipliers are separately programmable, but share a common range program. Multiplier ranges are from X1.0 to X10.9 in 0.1 incremental steps. Accurate within 10% above 10 ns on the 1-ns and 10-ns range, within 5% on the 100-ns and 1- μ s range. When $(t_r/t_f \text{ range}) \times (t_r \text{ or } t_f \text{ multiplier}) \times (\text{amplitude multiplier})$ is less than 10 ns, the output risetime or falltime is less than 11 ns, uncalibrated.

PULSE AMPLITUDE is programmed in 3 ranges (0.2 V, 0.5 V, 1 V) with multipliers from X2.0 to X9.9 in 0.1 incremental steps. Amplitude into 50 Ω is accurate within (3% + 15 mV) on 0.2-V range; within (3% + 25 mV) on 0.5-V range; within (3% + 50 mV) on 1-V range.

PULSE WIDTH is programmed in 4 decade ranges (10 ns, 100 ns, 1 μ s, 10 μ s) with each range programmed from X5.0 to X54.5 in 0.5 incremental steps. Accurate within 5% on 10-ns range, within 3% on all other ranges.

PULSE DC OFFSET RANGE is $-X4.9$ to $+X4.9$ in 0.1 incremental steps, times the pulse amplitude range. Accurate within (5% + 100 mV).

TYPE R116 MOD 703L

Includes: 5 program assemblies for the Type R250; board P7, pulse delay (672-0207-01); board P8, pulse period, mode (672-0208-01); board P9, pulse width, amplitude, t_r/t_f decade, offset (672-0208-02); board P10, pulse width multiplier, amplitude multiplier (672-0209-01); board P11, pulse risetime multiplier, falltime multiplier (672-0209-02); Type R116 MOD 703L to Type R250 interconnecting cable; test format tables; standard accessories of Type R116; two instruction manuals with MOD 703L information added.



TYPE R293 MOD 703M

The Type R293 MOD 703M is a modified Tektronix Type R293 Programmable Pulse Generator and Power Supply Unit furnished with a program assembly (1 shift register card with 2 program boards installed and wired) for the Type R250, designed to program the pulse amplitude and pulse width of the Type R293. All input and output connectors of the Type R293 are moved to the rear panel. The following performance characteristics apply to the Type R293 MOD 703M programmed by the Tektronix Type 240 Program Control Unit via the Type R250 Auxiliary Program Unit and using the program assembly card furnished with the Type R293. Other characteristics of the Type R293 Programmable Pulse Generator and Power Supply Unit may be found in Tektronix Catalog #27, pages 278 and 279.

PULSE AMPLITUDE is programmed with 4 bits in 0.5-V increments over a range of 6 V to 12 V, accurate within 3% of programmed value.

PULSE WIDTH is programmed with 10 bits in 1-ns increments over a range from 2 ns to 250 ns, accurate within (3% + 3 ns).

TYPE R293 MOD 703M

Includes: Program assembly board for Type R250 (672-0210-01); Type R293 to Type R250 interconnecting cable; measurement format table; two instruction manuals with MOD 703M additions; plus included standard accessories of the Type R293.



TYPE S-3130 DIGITAL MEASUREMENT SYSTEM



- **DYNAMIC MEASUREMENT**
PULSE RISETIME AND FALLTIME
PULSE WIDTH AND PERIOD
PROPAGATION DELAY AND STORAGE TIME
PULSE AMPLITUDE AND SATURATION VOLTAGE
MANY OTHER SPECIFIC MEASUREMENTS
- **1600 MEASUREMENT STORAGE**
- **PROGRAMMABLE**
PULSE GENERATOR
POWER SUPPLIES
- **100 MEASUREMENTS PER SECOND**
- **400-ps RISETIME**
- **PROGRAM BRANCHING FOR DIAGNOSTIC TESTING**
- **100 ps/DIV to 500 ms/DIV**
CALIBRATED SWEEP RANGE
- **20 mV/DIV to 2 V/DIV**
CALIBRATED VOLTAGE RANGE

TYPE S-3130

The Type S-3130 Digital Measurement System is a dynamic measurement system intended for measuring the performance of active devices under simulated operating conditions. It is designed to test integrated circuits, transistors, diodes, circuit modules, circuit boards and sub-assemblies in all segments of the electronic industry. Typical areas of application are found in production testing, QC, incoming inspection and preproduction.

The Type S-3130 can sequence through measurements at a rate of more than 100 measurements per second. The Disc Memory provides local storage and random access to 1600 independent measurements, and permits sorting and classifying. Diagnostic test routines may also be performed. Provisions are made for a computer or other control device to control the measurement or measurement routine. The computer can make calculations based on test data and employ the Disc Memory for further measurements.

The following instruments comprise the Type S-3130: Type R568 Oscilloscope with the Type 3T6 Programmable Sampling Sweep and Type 3S6 Programmable Sampling Unit, two Type S-3 Sampling Heads, Type R240 Program Control Unit, Type R250 Auxiliary Program Unit, Type R116 MOD 703L Programmable Pulse Generator, four Programmable Power Supplies, a Disc Memory, Punched Tape Reader, Probe Choppers, and a dual-bay enclosed cabinet with an operator table containing Test Station at one side. Several options for the Type S-3130 are available to satisfy specific measurement requirements.

VERTICAL AMPLIFIER

Vertical characteristics are stated with the 10X attenuator. Either the 10X or 100X attenuators must be used with the included probe choppers.

Voltage measurements are from 20 mV/div to 2 V/div (8 div full scale) accurate within 3%.

Bandwidth is equivalent to DC to 875 MHz.

Risetime is less than or equal to 400 ps.

Input characteristics are 1 M Ω paralleled by 2 pF.

Programmable DC offset is from +9.95 V to -9.95 V in 50-mV steps.

TIME BASE

Programmable sweep time/div is from 100 ps/div to 0.5 s/div in 30 calibrated steps, accurate within 3%.

Programmable digital delay range is from 0 to 999.9 μ s in increments of 100 ps, 1 ns or 100 ns, depending on the sweep time/div.

Automatic triggering eliminates the need for trigger adjustments over a wide range of trigger amplitudes, shapes and repetition rates. Automatically triggers on signals of 100-mV to 500-mV amplitude over a frequency range from DC to 100-MHz.

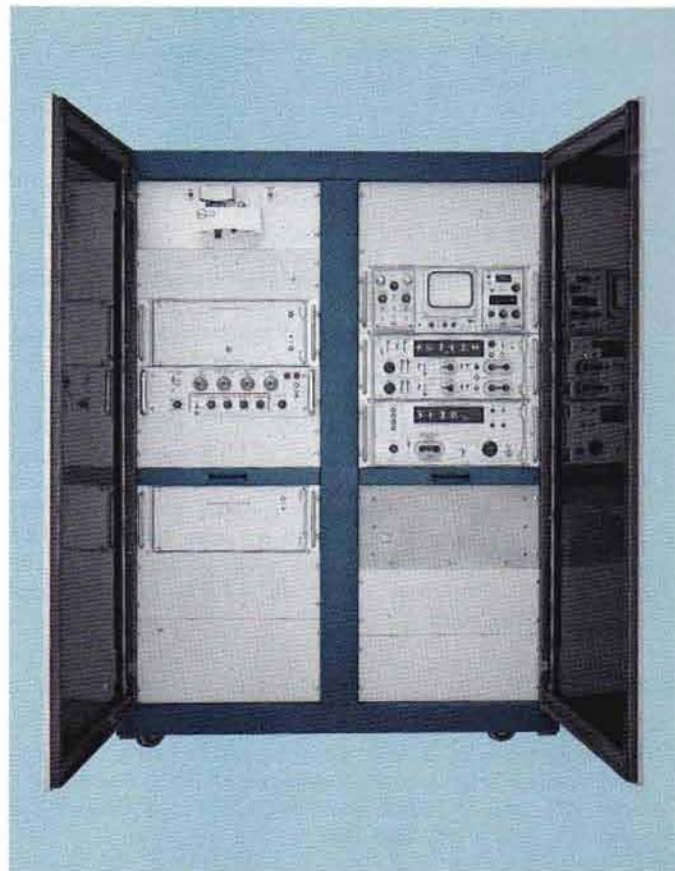

DIGITAL UNIT

Units of measure are readout in V, mV, ns, μ s, ms, s.

Numerical readout is from -3999 to +3999.

Programmable measurement limits are from -3999 to +3999.

Data output is in parallel BCD code, 29 lines; 1, 2, 4, 8; true = ground, false = +12 V.

MEMORY AND PROGRAMMING

Storage capacity is 1600 measurements. Programming format is a fixed word length of 96 4-bit characters. A parity check is made on each character read into the Type 240 Program Control Unit. Program access time is 17 ms average and can be optimized to approximately 1 ms through minimum-access time programming. 360 parallel program lines are available to various systems instruments.

THREE 40-VOLT PROGRAMMABLE POWER SUPPLIES

Operating ranges from 0 to \pm 40 V, programmed in 10-mV steps, repeatable within 0.5%, \pm 3 mV. Output slewing rate is 20 V/ms. Load regulation is within 0.25% or 1 mV, whichever is greater. Line regulation is within 0.02% or 0.5 mV, whichever is greater. Ripple is less than 3 mV RMS.

TYPE S-3130

80-VOLT PROGRAMMABLE POWER SUPPLY

Operating range is from 0 V to ± 79.9 V, programmed in 100-mV steps, repeatable within 1.0%, ± 3 mV. Output slewing rate is 20 V/ms. Load regulation is within 0.25% or 1 mV, whichever is greater. Line regulation is within 0.02% or 0.5 mV, whichever is greater. Ripple is less than 3 mV RMS.

PROGRAMMABLE PULSE GENERATOR

The Type R116 Programmable Pulse Generator is modified (MOD 703L) to include 5 program assembly cards, that provide digital-to-analog conversion of program data. The Type R116 is calibrated with the program assembly cards that are mounted in the Type R250. The input and output connectors of the Type R116 are moved to the rear panel.

All functions of the Type R116 MOD 703L are programmed in the Type S-3130. These functions include: pulse period from 100 ns to 10.9 ms; pulse delay/period from 50 ns to 545 μ s; pulse width from 50 ns to 545 μ s; pulse amplitude from 0.4 V to 9.9 V; pulse risetime and falltime from 10 ns to 109 μ s; pulse DC offset from -4.9 V to $+4.9$ V. For additional information see page 43.

DISPLAY UNIT

CRT display is 8 x 10 cm with P31 phosphor. Calibrator provides 20 kHz accurate within 0.05%, and approximately 1-kHz signals; amplitudes of 0.5 V and 5 V P-P within 2% into ≥ 100 -k Ω load, or 50 mV and 500 mV P-P within 2% into a 1% 50- Ω load.

TEST STATION

The Test Station is in the operator table and provides the interface between the Type S-3130 and the device under test. Test inputs and outputs of the Type S-3130, including 32 program lines, are available on a 56-pin connector and through 50- Ω connectors located in the Test Station. A test fixture card that contains a socket for the device under test, and the appropriate test circuitry for input and output signals, can quickly and easily be inserted into the Test Station. This feature permits the test fixture to be easily changed when various devices are to be checked. Two unwired test fixture cards are included with the Type S-3130. They require circuit design and wiring to obtain a proper interface to the device under test. A system performance check-out test fixture card is also included. Consult your Field Engineer, Representative, or Distributor for quotations on wired test fixture cards for specific devices and tests.

DIMENSIONS

The Type S-3130 is 62 $\frac{1}{2}$ inches high, 99 inches wide, and 46 inches deep, including the operator table. Instruments are mounted on slide-out tracks and individually can be pulled out, tilted, and locked in any one of seven positions for convenient access.

POWER REQUIREMENTS

105 V to 125 V, 60 Hz, approx 1000 watts at 115 V and 60 Hz. Rear panel selectors on each instrument provide rapid accommodation for line-voltage ranges.

INSTALLATION

A Tektronix System Technician installs the Type S-3130. He checks the complete system for proper operation, and assures that it meets or exceeds published specifications.

FACTORY TRAINING

Tektronix provides an intensive 3-week System Training course on the Type S-3130. Theory of operation, programming, calibration, and trouble-shooting are discussed for each System instrument, as well as the complete System. Classes are held at the Tektronix Industrial Park, Beaverton, Oregon.

TYPE S-3130 DIGITAL MEASUREMENT SYSTEM

Includes the following instruments in a dual-bay enclosed cabinet with operator table containing a Test Station at one side: Type R568 Oscilloscope; Type R230 Digital Unit; Type R240 Program Control Unit; Type R250 Program Unit; Type 3S6 Programmable Sampling Unit; Type 3T6 Programmable Sampling Sweep; two Type S-3 Sampling Heads; Type R116 Programmable Pulse Generator MOD 703L; Disc Memory; Punched Tape Reader; four Programmable Power Supplies; two Probe Choppers; two unwired test fixture cards; a performance check-out test fixture card; and includes the standard accessories of the above instruments.

PUNCHED TAPE PROGRAMMING ONLY

The Type S-3131 is identical to the standard Type S-3130 with the exception that the Disc Memory is deleted and programming is accomplished with the Punched Tape Reader. The maximum measurement rate with the Punched Tape Reader is 3 measurements per second. The Disc Memory can be added to the system at any time.

TYPE S-3131 DIGITAL MEASUREMENT SYSTEM

DISC MEMORY PROGRAMMING ONLY

The Type S-3132 deletes the Punched Tape Reader from the standard Type S-3130 and maintains the maximum measurement rate of 100 measurements per second. The Punched Tape Reader can be added to the system at any time.

TYPE S-3132 DIGITAL MEASUREMENT SYSTEM

OPTIONS

DUAL-TEST STATIONS

Dual-Test Stations are available for the Type S-3130 that permits full use of its measurement speed of 100 measurements per second. This lets the Type S-3130 scan the two test stations, making measurements from either station on command. If the Type S-3130 is making a measurement at one station and receives a start command from the other station, it finishes the first measurement sequence before switching stations.

Each station has separate test fixture cards that permit checking different devices at each station. The station selects its own measurement sequence, indicates the measurement limit results (high, low, go), has a start and reset button, and indicates the station's condition of test (in process or waiting).

Order 015-0133-00

SELF-CALIBRATION

The self-calibration option checks and adjusts, when necessary, the vertical deflection factor (5 mV/div to 100 mV/div) and the horizontal sweep rates (1 ns/div to 0.5 s/div) to within 1%*.

Order 015-0131-00

TAPE PUNCH

The Tape Punch provides punched tape copies of program data stored in the Disc Memory. The Tape Punch can be ordered installed, when ordering a Type S-3130.

TYPE R250 AUXILIARY PROGRAM UNIT

An additional Type R250 can be added to the Type S-3130 System. The Type R250 adds 192 program lines that can be used to program additional power supplies, pulse generators, programmable fixtures, automatic handles, or other programmable equipment. Consult your Tektronix Field Engineer, Representative, or Distributor for a quotation on the Type R250 designed to do your specific programming job.

The Type S-3130 is also available with different Sampling Heads featuring up to 25-ps risetime capabilities, and data recording options. Consult your Field Engineer, Representative, or Distributor for additional information.

*Accuracy on 1 mV/div and 10 mV/div positions is within 5% and 2% respectively.

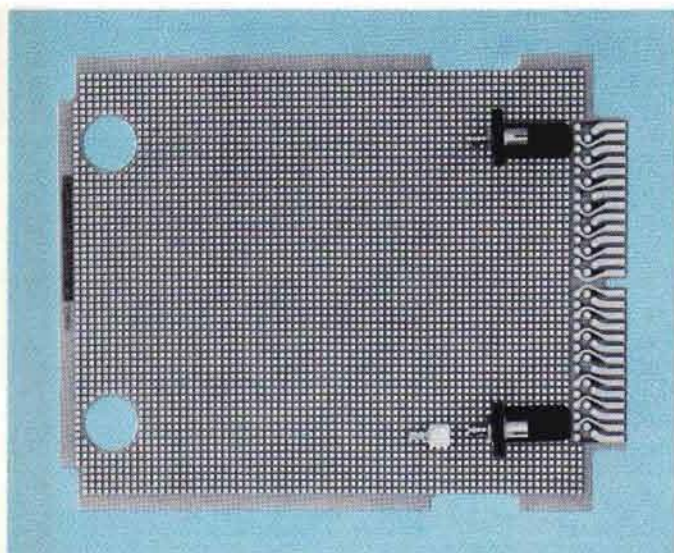

TEST FIXTURE CARDS

Additional unwired test fixture cards can be ordered at any time. They require circuit design and wiring to obtain a proper interface to the device under test. The fixture card mates to the 56-pin connector in the Type S-3130 and has a coaxial connector for the pulse generator input and has two probe connectors mounted on the card.

Order 670-1016-00

TEKTRONIX, INC.

P. O. Box 500, Beaverton, Oregon 97005

Telephone: (503) 644-0161 TWX—503-291-6805 Telex: 036-691 Cable: TEKTRONIX

FIELD ENGINEERING OFFICES

ALABAMA

Huntsville
Telephone: (205)881-2912

ARIZONA

Phoenix (Scottsdale)
Telephone: (602)946-4273
Tucson Area: Enterprise 383

CALIFORNIA

Alhambra
Telephone: (213)576-1601
From L.A. call: 283-0501

Orange
Telephone: (714)633-3450

Palo Alto
Telephone: (415)326-8500

San Diego
Telephone: (714)283-6225

Santa Barbara
Telephone: ((805)963-1848
From Island of Oahu,
Hawaii Area: Enterprise 5-700

Van Nuys
Telephone: (213)987-2600
From L.A. call: 873-6868

Walnut Creek
Telephone: (415)935-6101
From Oakland, Berkeley, Richmond,
Albany & San Leandro: 254-5353

COLORADO

Denver
Telephone: (303)757-1249

CONNECTICUT

Hartford (East Hartford)
Telephone: (203)289-8695

Stamford
Telephone: (203)325-3817

FLORIDA

Orlando
Telephone: (305)841-2382
From the Cape Kennedy Area:
636-0343
Also serves Puerto Rico and
U.S. Virgin Islands

GEORGIA

Atlanta
Telephone: (404)633-0344

ILLINOIS

Park Ridge
Telephone: (312)825-6666

Hinsdale
Telephone: (312)325-3050

INDIANA

Indianapolis
Telephone: (317)546-2408

KANSAS

Kansas City (Mission)
Telephone: (913)HEdrick 2-1003

MARYLAND

Baltimore (Lutherville)
Telephone: (301)825-9000
From Harrisburg, Lancaster and
York Area call: Enterprise 1-0631

Rockville
Telephone: (301)427-0700

MASSACHUSETTS

Boston (Waltham)
Telephone: (617)894-4550

MICHIGAN

Detroit (Southfield)
Telephone: (313)358-3122

Lansing
Telephone: (517)393-5280

MINNESOTA

Minneapolis
Telephone: (612)545-2581
St. Paul (Edina)
Telephone: (612)920-1860

MISSOURI

St. Louis
Telephone: (314) JACkson 4-0900

NEW JERSEY

Cherry Hill
Telephone: (609)667-4333

Springfield
Telephone: (201)379-1670

NEW MEXICO

Albuquerque
Telephone: (505)268-3373
Southern New Mexico Area:
Enterprise 678

NEW YORK

Buffalo
Telephone: (716)633-7861

Endicott
Telephone: (607) Pioneer 8-8291

Poughkeepsie
Telephone: (914)471-3620

Roslyn Heights, L.I.
Telephone: (516) HT 4-2300

Syracuse
Telephone: (315)455-6666

NORTH CAROLINA

Greensboro
Telephone: (919)274-4647

OHIO

Cleveland
Telephone: (216)884-6558

Columbus (Worthington)
Telephone: (614)888-4040

Dayton
Telephone: (513)293-4175

PENNSYLVANIA

Philadelphia (Bala-Cynwyd)
Telephone: (215) Tennyson 9-3111

Pittsburgh (Monroeville)
Telephone: (412)351-3345

TEXAS

Dallas
Telephone: (214) MEIrose 1-4560

Houston
Telephone: (713) NATIONAL 2-8141
New Orleans, Louisiana Area:
WX 3093

San Antonio
Telephone: (512) TAYlor 6-0686

UTAH

Salt Lake City
Telephone: (801)484-8501

VIRGINIA

Alexandria
Telephone: (703)751-6096

Hampton
Telephone: (703)826-4020

WASHINGTON

Seattle
Telephone: (206) CHerry 3-2494
From Pullman, Richland, Spokane,
Yakima: Zenith 9369

From Portland, Corvallis, Eugene
(Oregon): Commerce 9369

WISCONSIN

Milwaukee
Telephone: (414)476-6850

TEKTRONIX INTERNATIONAL FIELD OFFICES

AUSTRALIA

Tektronix Australia Pty. Limited
Sydney .. Telephone: 211-2666
Melbourne .. Telephone: 51-1592
Adelaide .. Telephone: 23-2811

CANADA

Tektronix Canada Ltd.
Montreal .. Telephone: (514)731-3761
Ottawa .. Telephone: (613)828-5171
Toronto .. Telephone: (416)638-6404
Vancouver .. Telephone: (604)736-0265

FRANCE

Relations Techniques Intercontinentales
Paris .. Telephone: 727-43.09 & 727-08.36
Lyon .. Telephone: (78) 72.00.70
Nice .. Telephone: (93) 84.05.93
Rennes .. Telephone: (99) 00.84.42
Toulouse .. Telephone: (61) 42.04.50

JAPAN

Sony/Tektronix Corporation
Tokyo .. Telephone: 493-3311 (Arear 03/Tokyo)

SWITZERLAND

Tektronix International A.G.
Zug .. Telephone: 042 49192

UNITED KINGDOM

Tektronix U.K. Ltd.
Harpenden, Herts .. Telephone: Harpenden 61251

INTERNATIONAL DISTRIBUTORS

Supplied and Supported by Tektronix Limited, P. O. Box 36, St. Peter Port, Guernsey, Channel Islands
Telephone: Guernsey 23411, Telex: 41193

ANGOLA

Equipamentos Tecnicos, Lda.
Luanda .. Telephone: Luanda 6917

AUSTRIA

Inglomark Markowitsch & Co.
Wien .. Telephone: (0222) 83-05-08

BELGIUM

Regulation Mesure, SPRL
Bruxelles .. Telephone: 71.20.20

DENMARK

Tage Olsen A.S.
Copenhagen .. Telephone: (01) 29.48.00

FINLAND

Into O/Y
Helsinki .. Telephone: 11123

GREECE

Marios Dalleggio Representations
Athens .. Telephone: 710.669

ISRAEL

Eastronics Limited
Tel Aviv .. Telephone: 446060

ITALY

Silverstar Ltd.
Milano .. Telephone: 46.96.551/2/3/4/5 &
49.80.151/2/3/4/5
Roma .. Telephone: 855.366, 869.009,
854.554 & 854.529
Torino .. Telephone: 540.075 & 543.527

LEBANON

Projects
Beirut .. Telephone: 241200

MOZAMBIQUE

Equipamentos Tecnicos, Lda.
Lourenco Marques .. Telephone: 2601

The NETHERLANDS

C.N. Rood, N.V.
Rijswijk .. Telephone: The Hague 98.51.53

NORWAY

Morgenstjerne & Co. A/S
Oslo .. Telephone: 20-16-35

PORTUGAL

Equipamentos de Laboratorio Lda.
Lisboa .. Telephone: 73.34.36 & 73.34.37

REPUBLIC OF SOUTH AFRICA

Protea Physical & Nuclear Instrumentation (Pty) Ltd.
Johannesburg .. Telephone: 838-8351

SPAIN

C. R. Mares, S.A.
Barcelona .. Telephone: 257.62.00
Madrid .. Telephone: 243-08-38

SWEDEN

Erik Ferner, A.B.
Bromma .. Telephone: 08/252870
Goteborg .. Telephone: 031-444130

TURKEY

M. Suheyl Erkman
Istanbul .. Telephone: 441546

WEST GERMANY

Rohde & Schwarz Handels-GmbH
Berlin .. Telephone: 34 05 36

Rohde & Schwarz Vertriebs-GmbH
Karlsruhe .. Telephone: 2 39 77

Hamburg .. Telephone: 38 14 66

Koeln .. Telephone: 23 30 06

Munchen .. Telephone: 52 10 41

INTERNATIONAL DISTRIBUTORS

Supplied and Supported by Tektronix, Inc., P. O. Box 500, Beaverton, Oregon, U.S.A. 97005
Telephone: (503) 644-0161 Telex: 036-691 Cable: TEKTRONIX

ARGENTINA

Coasin S.A.
Buenos Aires .. Telephone: 52-3185

BRASIL

Importacao Industria E Comercio Ambriex, S.A.
Rio de Janeiro .. Telephone: 42-7990 & 42-7291

CHILE

Pentz y Cia., Ltda.
Santiago .. Telephone: 63010

COLOMBIA

Manuel Trujillo Venegas e Hijo Ltda.
Bogota .. Telephone: 48-57-72

INDIA

Hinditron Services Private Limited
Bombay

MEXICO

Fredin S.A.
Mexico .. Telephone: 46-44-21

NEW ZEALAND

W & K McLean, Ltd.
Auckland .. Telephone: 34-541

PAKISTAN

Pak-Land Corporation
Karachi .. Telephone: 47315

PERU

Importaciones y Representaciones Electronicas, S.A.
Lima .. Telephone: 72076

VENEZUELA

Tecnica Nuclear de Venezuela, C.A.
Caracas .. Telephone: 54-39-56

TEKTRONIX FIELD SERVICES

Tektronix Customers are urged to take advantage of the many field services available to them through Tektronix Field Engineering Offices and Overseas Representatives. Some of these services are described below.



ORDERING—There are many types of oscilloscopes, each designed for a specific application area. Your Field Engineer can help you select the one best suited to your present and future needs, and he will be happy to arrange a demonstration of the instrument . . . in your application if you so desire.

If you are a Purchasing Agent or Buyer, your Field Engineer or his secretary can provide information on prices, terms, shipping estimates, and best method of transportation on instruments, accessories, and replacement parts.

OPERATION—Your Tektronix Oscilloscope can be most useful to you when you are familiar with all control functions. Your Field Engineer will be glad to demonstrate the use of your instrument in various applications to help you become more familiar with its operation. If your instrument is to be used by several engineers, your Field Engineer will be happy to conduct informal classes on its operation in your laboratory.

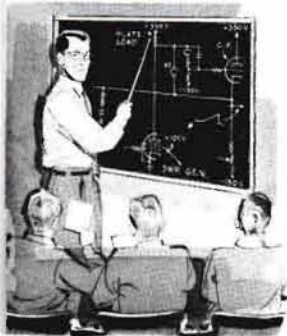

In a large laboratory, your Field Engineer can be of service to your maintenance engineers by conducting informal classes on test and calibration procedures, trouble-shooting techniques, and general maintenance.

MAINTENANCE—Tektronix willingly assumes much of the responsibility for continued efficient operation of the instruments it manufactures. If you should experience a stubborn maintenance problem, your Field Engineer will gladly help you isolate the cause. Often a telephone discussion with him will help you get your instrument back in operation with minimum delay. If yours is a



If you are responsible for the maintenance of a large quantity of Tektronix Instruments, ask your Field Engineer about the free factory training course in maintenance and calibration.



APPLICATIONS—Perhaps the answers you need in a specific application can be obtained faster and easier through use of your Tektronix Oscilloscope. Your Field Engineer can help you find out, and if use of your oscilloscope is indicated, help you with procedures. He may also be able to suggest many time-saving uses for your oscilloscope in routine checks and measurements.

INSTRUMENT RECONDITIONING—An older Tektronix Oscilloscope, properly reconditioned, can give you many additional years of service. Your Field Engineer will gladly explain the advantages of instrument reconditioning, major repair, and recalibration that can be performed at a nearby Field Service Center. Ask your Field Engineer about this service to Tektronix customers.



COMMUNICATIONS—Your Field Engineer is a valuable communication link between you and the factory. He knows the exact person to contact in each circumstance, and he can reach that person fast and easily. Let him help speed your communications on any problem related to your Tektronix Instruments.

CONTENTS

INTRODUCTION

Introduction	Inside Front Cover
Tektronix Field Services	1
Contents	2
Reference Chart	6
Reference Information	9
Ordering Information	12
Field Offices and Overseas Distributors	13
Instrument Dimensions	17
Abbreviations	19
Glossary of Terms	20

PORTABLE OSCILLOSCOPES

321A	DC to 6 MHz—AC/DC or Battery	28
422, R422	DC to 15 MHz—AC, AC/DC or Battery	34
453, R453	DC to 50 MHz—Sweep Delay	38
454, R454	DC to 150 MHz—Sweep Delay	43

SPECTRUM ANALYZERS

491, R491	10 MHz to 40 GHz Portable	48
Plug-ins for 530, 540, 550, 580-Series Oscilloscopes		
1L5	50 Hz to 1 MHz Plug-in Unit	142
1L10	1 MHz to 36 MHz Plug-in Unit	144
1L20	10 MHz to 4.2 GHz Plug-in Unit	145
1L30	925 MHz to 10.5 GHz Plug-in Unit	145
Plug-ins for 560-Series Oscilloscopes		
3L5	50 Hz to 1 MHz Plug-in Unit	183
3L10	1 MHz to 36 MHz Plug-in Unit	185

LOW-FREQUENCY OSCILLOSCOPES

502A, RM502A	100 μ V/cm Dual-Beam	52
503, RM503	DC to 450 kHz—X-Y	55
504, RM504	DC to 450 kHz	57

GENERAL-PURPOSE OSCILLOSCOPES

310A	DC to 4 MHz	23
317, RM17	DC to 10 MHz	25
515A, RM15	DC to 15 MHz	59
516	DC to 15 MHz—Dual-Trace	62

SPECIAL-PURPOSE OSCILLOSCOPES

410	Physiological Monitor	31
507	High Voltage, Surge Test	281
519	350-ps Risetime	64
RM544	1-ns Risetime	281
Mod 720A		

TELEVISION OSCILLOSCOPES

453	DC to 50 MHz Television	
MOD 127C	Oscilloscope	38
520, R520	NTSC Vectorscope	67
520, R520	PAL Vectorscope	71
529, RM529	Waveform Monitor	75
TV Accessories		79

TYPE 530, 540, 550, 580 SERIES PLUG-IN UNIT OSCILLOSCOPES

Type 530-Series Oscilloscopes

531A, RM31A	DC to 15 MHz	80
533A	DC to 15 MHz—X100 Magnifier	83
535A, RM35A	DC to 15 MHz—Sweep Delay	86
536	DC to 11 MHz—X-Y	89

Type 540-Series Oscilloscopes

543B, RM543B	DC to 33 MHz—X100 Magnifier	92
544, RM544	DC to 50 MHz—X100 Magnifier	95
545B, RM545B	DC to 33 MHz—Sweep Delay	98
546, RM546	DC to 50 MHz—Sweep Delay	101
547, RM547	DC to 50 MHz—Sweep Delay	
	Automatic Display Switching	104
549	Split-Screen Storage—Sweep Delay	108

Type 550-Series Oscilloscopes

551	DC to 27 MHz—Dual-Beam Vertical	113
555	DC to 33 MHz—Dual-Beam—Sweep Delay	280
556, R556	DC to 50 MHz—Dual-Beam—Sweep Delay	116

Type 580-Series Oscilloscopes

581A	DC to 80 MHz	223
585A, RM585A	DC to 80 MHz—Sweep Delay	225
81A	Plug-in Adapter (for 1 and Letter-Series Plug-in Units)	228
82	DC to 80 MHz Dual-Trace Plug-in	229
86	DC to 80 MHz Plug-in	230

PLUG-IN UNITS

FOR TYPE 530, 540, 550, 580-SERIES OSCILLOSCOPES

Multi-Trace Plug-ins

1A1	DC to 50 MHz Dual-Trace	131
1A2	DC to 50 MHz Dual-Trace	133
1A4	DC to 50 MHz Four-Trace	134
CA	DC to 24 MHz Dual-Trace	280
M	DC to 20 MHz Four-Trace	280

CONTENTS

TYPE 560-SERIES PLUG-IN UNIT OSCILLOSCOPES

561A, RM561A	DC to 15 MHz—X-Y	151
564, RM564	Split-Screen Storage—X-Y	155
565, RM565	Dual-Beam—Delayed Sweep	160

PLUG-IN UNITS

FOR TYPE 560-SERIES OSCILLOSCOPES

Multi-Trace Plug-ins

3A1	DC to 10 MHz Dual-Trace	281
3A3	100 μ V/div Dual-Trace Differential	167
3A6	DC to 10 MHz Dual-Trace	172
3A72	DC to 650 kHz Dual-Trace	176
3A74	DC to 2 MHz Four-Trace	177

Differential Plug-ins

2A61	Differential	164
2A63	Differential	165
3A3	100 μ V/div Dual-Trace Differential	167
3A7	Differential Comparator	173

Sampling Plug-ins

3S1	350-ps Dual-Trace Sampling	187
3S2	Dual-Trace Sampling	188
S1	350-ps Sampling Head	189
S2	50-ps Sampling Head	189
3S3	350-ps Dual-Trace Sampling-Probe	190
3T2	Random Sampling Sweep	191
3T4	Programmable Sampling Sweep	192
3T77A	Sampling Sweep	193

Spectrum Analyzer Plug-ins

3L5	50 Hz to 1 MHz Spectrum Analyzer	183
3L10	1 MHz to 36 MHz Spectrum Analyzer	185

Single-Trace Plug-ins

2A60	DC to 1 MHz	163
3A5	DC to 15 MHz Automatic/ Programmable Amplifier	169
3A75	DC to 4 MHz	178

Special Purpose Plug-ins

3A8	Operational Amplifier	174
3C66	Carrier Amplifier	181

Time-Base Plug-ins

2B67	Time-Base	166
3B3	Time-Base—Delayed Sweep	179
3B4	Time-Base—X50 Magnifier	180

Plug-in Unit Power Supply

129	Plug-in Unit Power Supply	264
-----	---------------------------	-----

Differential Plug-ins

1A5	DC to 50 MHz Differential Comparator	136
1A6	DC to 2 MHz Differential	138
1A7A	10 μ V/cm Differential	139
D	DC Differential	280
E	AC Differential	280
G	DC to 20 MHz Differential	121
W	DC to 20 MHz Differential Comparator	129
Z	Differential Comparator	280

Sampling Plug-ins

1S1	350-ps Sampling	147
1S2	Time-Domain Reflectometer	149

Spectrum Analyzer Plug-ins

1L5	50 Hz to 1 MHz Spectrum Analyzer	142
1L10	1 MHz to 36 MHz Spectrum Analyzer	144
1L20	10 MHz to 4.2 GHz Spectrum Analyzer	145
1L30	925 MHz to 10.5 GHz Spectrum Analyzer	145

Single-Trace Plug-ins

B	DC to 20 MHz	120
H	DC to 15 MHz	122
K	DC to 30 MHz	123
L	DC to 30 MHz	124

Special Purpose Plug-ins

O	Operational Amplifier	125
Q	Transducer and Strain Gage	127
T	Time-Base Generator	89

Plug-in Unit Power Supplies

127	Plug-in Unit Power Supply	262
132	Plug-in Unit Power Supply	267
133	Plug-in Unit Power Supply	268

CONTENTS

SAMPLING OSCILLOSCOPES

Plug-ins for 530, 540, 550, 580-Series Oscilloscopes	
1S1	350-ps Sampling 147
1S2	90-ps Reflectometer and Sampling . 149
Plug-ins for 560-Series Oscilloscopes	
3S1	350-ps Dual-Trace Sampling 187
3S2	Dual-Trace Sampling 188
S1	350-ps Sampling Head 189
S2	50-ps Sampling Head 189
3S3	350-ps Dual-Trace Sampling-Probe . 190
3T2	Random Sampling Sweep 191
3T4	Programmable Sampling Sweep 192, 216
3T77A	Sampling Sweep 193
661	90-ps Sampling Oscilloscope 246
4S1	350-ps Dual-Trace Sampling 248
4S2A	90-ps Dual-Trace Sampling 249
4S3	350-ps Dual-Trace Sampling-Probe . 250
5T3	Sampling Sweep 251

DIGITAL READOUT AND PROGRAMMABLE OSCILLOSCOPES

567, R567	Digital Readout Oscilloscope 196
6R1A	Digital Unit 198
262	Programmer 200
568, R568	Digital Readout Oscilloscope 202
230, R230	Digital Unit 204
S-3100	Programmable Measurement System 207
Plug-ins for 567, 568 Digital Oscilloscopes	
3A2	Analog/Digital Dual-Trace Amplifier 211
3B2	Analog/Digital Time-Base 211
3S1	350-ps Dual-Trace Sampling 187
3S2	Dual-Trace Sampling 188
S1	350-ps Sampling Head 189
S2	50-ps Sampling Head 189
3S3	350-ps Dual-Trace Sampling-Probe . 190
3T2	Random Sampling Sweep 191
3T4	Programmable Sampling Sweep 192, 216
3T77A	Sampling Sweep 193

AUTOMATIC/PROGRAMMABLE OSCILLOSCOPES

561A, RM561A	DC to 15 MHz—X-Y 151
564, RM564	Split-Screen Storage—X-Y 155
3A5	DC to 15 MHz Automatic/Programmable Amplifier Unit 169
3B5	Automatic/Programmable Time-Base Unit 170
263	3A5/3B5 Programmer 171

STORAGE INSTRUMENTS

549	Split-Screen Storage—Sweep Delay 108
564, RM564	Split-Screen Storage—X-Y 155
601	5-Inch Storage Display Unit 231
611	11-Inch Storage Display Unit 234

PHYSIOLOGICAL MONITOR

410	Physiological Monitor 31
-----	------------------------------------

TRANSISTOR CURVE TRACER

575	Transistor Curve Tracer 217
175	High-Current Adapter 221

RUGGEDIZED OSCILLOSCOPES

321A	DC to 6 MHz, AC/DC or Battery . . 28
422, R422	DC to 15 MHz, AC, AC/DC or Battery 34
453, R453	DC to 50 MHz—Sweep Delay . . . 38
454, R454	DC to 150 MHz—Sweep Delay . . . 43
647A, R647A	DC to 100 MHz 237
10A1	Differential Comparator Unit 240
10A2A	DC to 100 MHz Dual-Trace Unit . . . 242
11B1	Time-Base—X50 Magnifier Unit . . . 243
11B2A	Time-Base—Delayed Sweep Unit . . 244

DUAL-BEAM OSCILLOSCOPES

502A, RM502A	100 μ V/cm Dual-Beam 51
551	DC to 27 MHz—Dual-Beam Vertical 113
555	DC to 33 MHz—Dual-Beam Sweep Delay 280
556, R556	DC to 50 MHz—Dual-Beam Sweep Delay 116
565, RM565	Dual-Beam—Sweep Delay 160

CONTENTS

PULSE AND SIGNAL GENERATORS

106	Square-wave Generator	253
109	Pulse Generator	254
111	Pretrigger Pulse Generator	255
114	Variable Pulse Generator	257
R116	Programmable Pulse Generator	258
184	Time-Mark Generator	274
191	Constant-Amplitude Signal Generator	275
284	Pulse Generator	277
R293	Programmable Pulse Generator	278
160-Series		
160A	Power Supply	269
161	Pulse Generator	270
162	Waveform Generator	271
163	Pulse Generator	272
360	Indicator Unit	273

PREAMPLIFIER AND AMPLIFIER

122	Low-Level Preamplifiers	260
125	Power Supply	261
1121	X100 Amplifier	265

PLUG-IN UNIT POWER SUPPLIES

127	Plug-in Unit Power Supply	262
129	Plug-in Unit Power Supply	264
132	Plug-in Unit Power Supply	267
133	Plug-in Unit Power Supply	268

TRACE-RECORDING CAMERAS

C-12	Trace-Recording Camera	284
C-27	Trace-Recording Camera	286
C-30	Trace-Recording Camera	288
C-40	Trace-Recording Camera	289

SCOPE-MOBILE® CARTS

Scope-Mobile Carts	294
--------------------	-----

OTHER INSTRUMENTS

113	Delay Cable	256
130	L-C Meter	266
281	Time Domain Reflectometer Pulser	276
282	Probe Adapter	277
283, R283	Real Time Adapter	281
292	Semi-Conductor Tester Power Supply	281
360	Indicator Unit	273

PROBES AND ACCESSORIES

Probe Reference Chart	296
Voltage Probes	298-303, 306-311, 316-320
Current Probes	304-305, 312-315
Accessories	321-335

REFERENCE CHARTS

This table provides a reference for bandwidth (at 3-dB down) and risetime capabilities of Tektronix Oscilloscopes.

Prices listed in this table are for cabinet model oscilloscopes and include the plug-in units (when applicable) required to obtain the stated bandwidth.

A more complete description can be found in the individual instrument section.

Call your Tektronix Field Office or overseas Representative for assistance in selecting the instrument for your particular application. See pages 12 through 16 for the location of these offices.

TEKTRONIX OSCILLOSCOPES

(according to bandwidth capabilities)

MAXIMUM BANDWIDTH	RISE-TIME	OSCILLOSCOPE	PLUG-IN UNIT	MINIMUM	DUAL TRACE	CALIBRATED SWEEP DELAY	RACK-MOUNT AVAILABLE	PAGE	
				DEFL FACTOR					DEFL FACTOR AT MAX BW
Equiv to 7 GHz	50 ps	Type 561A	3S2, S2, S2 & 3T2	$\frac{2 \text{ mV/cm}}{2 \text{ mV/cm}}$	Yes	Time Positions Through Full Time Base (uncal)	Yes	187-189	
		Type 564		$\frac{2 \text{ mV/cm}}{2 \text{ mV/cm}}$				213-214	
		Type 568 Digital Readout						202	
Equiv to 3.9 GHz	90 ps	Type 530, 540, 550, 580 Series	1S2	$\frac{5 \text{ mV/cm}}{5 \text{ mV/cm}}$	No	Time Positions Through Full Time Base (uncal)	—	80-119 223-225	
		Type 661	4S2A, 5T3	$\frac{2 \text{ mV/cm}}{2 \text{ mV/cm}}$	Yes		No	246	
Equiv to 1 GHz	350 ps	Type 530, 540, 550, 580 Series	1S1	$\frac{2 \text{ mV/cm}}{2 \text{ mV/cm}}$	No	Time Positions Through Full Time Base (uncal)	—	80-119 223-225	
		Type 661	4S1, 5T3	$\frac{2 \text{ mV/cm}}{2 \text{ mV/cm}}$	Yes		No	246	
1 GHz	350 ps	Type 519	—	$\frac{\leq 10 \text{ V/cm}}{\leq 10 \text{ V/cm}}$	No	(uncal)	No	65	
Equiv to 1 GHz	350 ps	Type 561A	3S2, S1, S1 & 3T2	$\frac{2 \text{ mV/cm}}{2 \text{ mV/cm}}$	Yes	Time Positions Through Full Time Base (uncal)	Yes	187-189	
		Type 564		$\frac{2 \text{ mV/cm}}{2 \text{ mV/cm}}$				213-214	
Equiv to 1 GHz	350 ps	Type 561A	3S1 & 3T77A	$\frac{2 \text{ mV/div}}{2 \text{ mV/div}}$	Yes	Time Positions Through Full Time Base (uncal)	Yes	151	
		Type 564 Storage							155
		Type 567 Digital Readout							196
		Type 568 Digital Readout							202
150 MHz	2.4 ns	Type 454 Ruggedized Portable	—	$\frac{5 \text{ mV/div}}{20 \text{ mV/div}}$	Yes	Yes	Yes	43	
100 MHz	3.5 ns	Type 647A Ruggedized	10A2A & 11B2A	$\frac{10 \text{ mV/cm}}{10 \text{ mV/cm}}$	Yes	Yes	Yes	237	
80 MHz	4.4 ns	Type 581A	82	$\frac{10 \text{ mV/cm}}{100 \text{ mV/cm}}$	Yes	No	No	223	
		Type 585A	82	$\frac{10 \text{ mV/cm}}{100 \text{ mV/cm}}$	Yes	Yes	Yes	225	

REFERENCE CHARTS

MAXIMUM BAND-WIDTH	RISE-TIME	OSCILLOSCOPE	PLUG-IN UNIT	MINIMUM DEFL FACTOR	DUAL TRACE	CALI-BRATED SWEEP DELAY	RACK-MOUNT AVAIL-ABLE		PAGE
				DEFL FACTOR AT MAX BW					
50 MHz	7 ns	Type 453 Ruggedized Portable	—	$\frac{5 \text{ mV/div}}{20 \text{ mV/div}}$	Yes	Yes	Yes		38
		Type 544 with 100X Mag	1A1		Yes	No	Yes		95
		Type 546	1A1						101
		Type 547 Sweep Switching	1A1	$\frac{5 \text{ mV/cm}}{50 \text{ mV/cm}}$	Yes	Yes	Yes		104
		Type 556 Dual Beam	1A1 (2)						116
33 MHz	11 ns	Type 543B with 100X Mag	1A1		Yes	No	Yes		92
		Type 545B	1A1	$\frac{5 \text{ mV/cm}}{50 \text{ mV/cm}}$	Yes	Yes	Yes		98
		Type 555 Dual Beam	1A1 (2)		Yes	Yes	No		280
30 MHz	12 ns	Type 549 Storage	1A1	$\frac{5 \text{ mV/cm}}{50 \text{ mV/cm}}$	Yes	Yes	No		108
27 MHz	13 ns	Type 551 Dual Beam	1A1 (2)	$\frac{5 \text{ mV/cm}}{50 \text{ mV/cm}}$	Yes	No	No		113
15 MHz	24 ns	Type 422 AC, DC, or Battery Portable	—	$\frac{10 \text{ mV/div}}{10 \text{ mV/div}}$	Yes	No	Yes (AC)		34
		Type 515A	—	$\frac{50 \text{ mV/div}}{50 \text{ mV/div}}$	No	No	Yes		60
		Type 516	—	$\frac{50 \text{ mV/div}}{50 \text{ mV/div}}$	Yes	No	No		63
		Type 531A	1A1		Yes	No	Yes		80
		Type 533A with 100X Mag	1A1	$\frac{5 \text{ mV/cm}}{50 \text{ mV/cm}}$	Yes	No	No		83
		Type 535A	1A1		Yes	Yes	Yes		86
		Type 561A Automatic/Programmable Type 564 Automatic/Programmable Storage	3A5 & 3B5	$\frac{1 \text{ mV/div}}{10 \text{ mV/div}}$	No	Delayed Sweep Magnifier	Yes		151
11 MHz	32 ns	Type 536 X-Y	1A1	$\frac{5 \text{ mV/div}}{50 \text{ mV/div}}$	Yes	No	No		89

continued

REFERENCE CHARTS

MAXIMUM BAND-WIDTH	RISE-TIME	OSCILLOSCOPE	PLUG-IN UNIT	MINIMUM DEFL FACTOR	DUAL TRACE	CALIBRATED SWEEP DELAY	RACK-MOUNT AVAILABLE		PAGE
				DEFL FACTOR AT MAX BW					
10 MHz	35 ns	Type 317	—	$\frac{10 \text{ mV/div}}{10 \text{ mV/div}}$	No	No	Yes		25
		Type 561A	3A6 & 3B3						151
		Type 564 Storage	3A6 & 3B3	$\frac{10 \text{ mV/div}}{10 \text{ mV/div}}$	Yes	Yes	Yes		155
		Type 565 Dual Beam	3A6 (2)						160
6 MHz	60 ns	Type 321A AC, DC, or Battery Portable	—	$\frac{10 \text{ mV/div}}{10 \text{ mV/div}}$	No	No	No		28
4 MHz	90 ns	Type 310A	—	$\frac{10 \text{ mV/div}}{10 \text{ mV/div}}$	No	No	No		23
1 MHz	0.35 μs	Type 502A Dual Beam & X-Y	—	$\frac{100 \mu\text{V/cm}}{200 \text{ mV/cm}}$	No	No	Yes		51
450 kHz		Type 503 Differential & X-Y	—	$\frac{1 \text{ mV/cm}}{1 \text{ mV/cm}}$	No	No	Yes		54
		Type 504	—	$\frac{5 \text{ mV/cm}}{5 \text{ mV/cm}}$	No	No	Yes		57

REFERENCE INFORMATION

DESCRIPTIONS AND SPECIFICATIONS

All present regular-production Tektronix Instruments and Accessories are listed and described in this catalog. We hope that it contains the right kind and amount of information for you.

THE OSCILLOSCOPE

The principal Tektronix instrument is the cathode-ray oscilloscope, which is a three-dimensional display device. These three axes are designated: X (time-base or horizontal plane), Y (amplitude or vertical plane), and Z (brightness range of display). The X and Y axes convey precise quantitative information and are usually specified as TIME per division and/or VOLTS per division. The Z axis is usually modulated by blanking or unblanking voltages in order to eliminate retrace time from the presentation.

We have tried to describe all of the more significant features, capabilities, and limitations of Tektronix instruments in a way that will be of the most value to most customers. This cannot be done without knowingly omitting some things meaningful to only a few.

ENVIRONMENTAL CHARACTERISTICS

The following instruments are specifically designed for the more severe environments often encountered when they are used in portable or mobile applications:

321A, 422 and R422, 453 and R453, 454 and R454, 491 and R491, 647A and R647A.

The environmental characteristics listed include some or all of the following:

Temperature, Altitude, Humidity, Vibration, Shock, Electromagnetic interference (EMI, previously RFI), and Transportation.

Sample production instruments are tested periodically as part of a continual quality control process. Complete tests on every production instrument are undesirable as well as uneconomical.

The specifications for humidity, vibration, shock and transportation are intended to be beyond what can be expected in use, and operation at these extremes may cause minor physical deterioration. Such operation, however, should not cause electrical performance deterioration outside specifications. The specifications for temperature and altitude are such that continual use at the limits will not cause significant short term deterioration. Naturally, higher temperature operation can be expected to reduce long term reliability and should be avoided if possible. The EMI test is completely non-destructive.

For more specific information on the environmental characteristics and how they apply to the above instruments, please refer to the page covering that instrument.

BANDWIDTH AND RISETIME MEASUREMENTS

BANDWIDTH

Frequency-response characteristics are at the 3-dB down points unless otherwise stated.

Equipment for measuring frequency response (bandwidth) must be carefully selected to assure accurate readings. A generator which is correct in amplitude at just the low frequency and high frequency check points could prove misleading. Uniform frequency response measurements require a generator with "flat" output amplitude characteristics over its entire frequency range. Loading placed on the generator must also be considered. High frequency sinewave generators must usually be terminated to match their output impedance. For oscilloscopes having an upper frequency response in the area from 350 kilohertz through 100 megahertz, Tektronix uses Type 191 Constant Amplitude Signal Generator to check for high frequency roll-off characteristics.

RISETIME

A characteristic of importance to the pulse-measurement field is risetime. This parameter is generally a good indication of relative bandwidth. In short, faster risetime means greater bandwidth (in the direction of higher frequencies). The risetime of Tektronix Oscilloscopes is determined using a terminated 50- Ω pulse source (25 Ω -source impedance). Several factors must be considered in making risetime measurements. For reasonably accurate readings of risetime, the oscilloscope should be approximately 5 times faster than the signal to be measured. When risetime of the signal approaches risetime of the oscilloscope, the true signal risetime can be computed. Risetime of cascaded signals is calculated by taking the square root of the sum of the squares (of signal and oscilloscope risetimes). For example, a signal with a risetime of one nanosecond viewed on an oscilloscope with a risetime capability of one nanosecond will appear as approximately 1.4 nanoseconds.

RISETIME MEASUREMENT EQUIPMENT

In order to measure actual risetime of the oscilloscope, the input pulse should be free of overshoot and ringing, since risetime is generally measured between the 10% and 90% amplitude points on a waveform. Proper termination of the input-pulse source must also be considered. Tektronix uses Type 106 Square-wave Generator (approximately 1-ns risetime), or Type 109 Pulse Generator (less than 0.25-ns risetime) for checking risetime of general-purpose oscilloscopes.

VOLTAGE RATINGS

In general, peak to peak input voltage ratings are for DC and low-frequency values. Because of possible damage to input components, especially solid-state devices, continuous derating is required as frequency is increased. This is especially true with RF at high-sensitivity settings.

REFERENCE INFORMATION

MECHANICAL AND ELECTRICAL CONSIDERATIONS

VENTILATION

In general, a standard oscilloscope using 250 watts of power or more will have filtered forced-air cooling.

CLEARANCE

Under normal conditions, at least two inches of unobstructed space around the oscilloscope should be maintained to assure safe operating temperature. When rack-mounting an instrument, add approx 3 inches to the depth of the instrument for adequate clearance of rear connections (power cords, etc.). Should the chassis temperature become excessive, a thermal-cutout switch will interrupt the power and keep it off until a safe operating temperature is reached.

CONSTRUCTION

The oscilloscope chassis and cabinet are of aluminum alloy for lightweight durability.

FINISH

The oscilloscope front panel is anodized and the cabinet has blue-vinyl finish.

POWER REQUIREMENTS

In general, instruments are factory wired for operation at 115 volts AC. Newer instruments provide quick-change line-

voltage selectors for convenient selection of line-voltage operating ranges. Transformer taps in other instruments can be changed to accommodate specific line-voltage operating ranges or factory wired for a specific range if specified on the purchase order. Tektronix instruments are designed with electronically-regulated power supplies to compensate for changing line voltages.

TEKTRONIX-MANUFACTURED COMPONENTS

When standard commercially-available components do not meet rigid requirements of Tektronix Oscilloscopes and associated instruments, and suppliers cannot fulfill adequately this demand for these specialized components, Tektronix manufactures them.

Some of these special components manufactured by Tektronix for exclusive use in its own equipment include cathode-ray tubes, transformers, and ceramic terminal strips—in addition to precision potentiometers, capacitors, wire-wound resistors, inductors, semiconductor and solid-state devices.

Designed compactly for reliability and efficiency these Tektronix-manufactured components incorporate the highest standards of craftsmanship in meeting the special needs of particular instruments.

PHOTOGRAPHIC WRITING SPEED

Photographic writing speed is a figure of merit which describes the ability of a particular camera, film, oscilloscope, and phosphor to record fast moving traces. The writing speed figure expresses the maximum single event spot velocity (usually in centimeters per microsecond) which may be recorded on film.

The results achieved are a function of the combined system performance of the oscilloscope, camera, film, recording technique, and the ability of the film reader to make a consistent interpretation of the results. Prefogging and postfogging of the recording film improves the apparent photographic writing speed of a particular system but the results are unpredictable and difficult to repeat.

The illustration below shows one way in which writing speed can be measured. There is displayed a single trace of a damped sinewave whose frequency and amplitude is such that the rapidly rising and falling portions of the first cycle or two fail to record. The peak to peak amplitude of the sinewave should be three to four times as great as the horizontal distance occupied by one cycle.

The writing speed capability of the oscilloscope is determined as follows: mask out the sinewave peaks on the photograph leaving the central one-third visible. View the photograph while backlit. Starting from the left, find the first rapidly rising or falling portion of the damped sinewave which is discernible. Let D represent the vertical distance in centimeters between the peaks which are connected by this portion. The writing speed in centimeters per microsecond is calculated by:

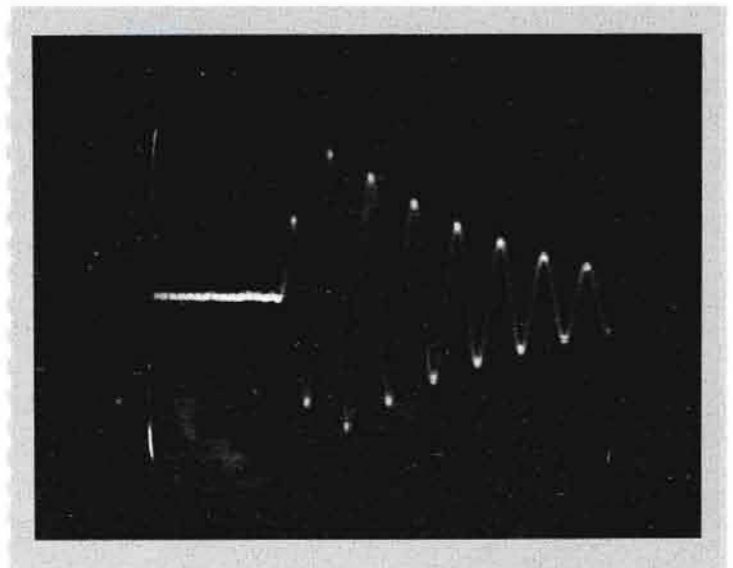

Photographic writing speed = $3.14Df$ where f is the frequency of the damped sinewave in megahertz.

Although the writing speed is an important characteristic of the oscilloscope, it does not completely describe the ability of the oscilloscope to present detailed information.

REFERENCE INFORMATION

CATHODE-RAY-TUBE PHOSPHOR DATA

The catalog description of each oscilloscope indicates the phosphor normally supplied. However, for specific applications, you may want to specify another phosphor. The phosphor data chart will help in your selection.

For more specific information regarding the best-suited phosphor for your particular application, please confer with your Tektronix Field Engineer, Representative or Distributor. He will know the factors that must be considered in

selection of a phosphor for any given application. For example, Type P11 is excellent for waveform photography but due to its short persistence, it is not well suited for applications requiring visual observation of low speed phenomena.

Phosphors are rated in several parameters, such as color of fluorescence or phosphorescence, decay, etc. The following table describes the more commonly used phosphors.

PHOSPHOR DATA CHART

Phosphor	Fluorescence	Phosphorescence Where Different Than Fluorescence	Relative Luminance ^(A)	Relative Photographic Writing Speed ^(B)	Decay to 0.1% (in ms)	Relative Burn Resistance	Comments
P-1	Yellowish-green	—	50%	20%	95	Medium	Replaced by P-31 in most applications.
P-2	Bluish-green	Yellowish-green	55%	40%	120*	Medium high	Good compromise for high and low speed applications.
P-4	White	—	50%	40%	20	Medium high	Television displays
P-7	Blue	Yellowish-green	35%	75%	1500*	Medium	Long decay, double layer screen.
P-11	Purplish-blue	—	15%	100%	20	Medium	For photographic applications
P-15	Bluish-green	—	15%	15%	0.05	Very high	Very short decay for flying spot scanner use.
P-31	Yellowish-green	—	100%	50%	32	High	General purpose, brightest available phosphor.

^(A) Taken with a Spectra Brightness Spot Meter which incorporates a CIE standard eye filter. Representative of 10 kV aluminized screens. P-31 as reference.

^(B) P-11 as reference with Polaroid 410 film. Representative of 10 kV aluminized screens.

* Low level lasts over one minute under conditions of low ambient illumination.



INTERNATIONAL FIELD OFFICES AND DISTRIBUTORS

TEKTRONIX INTERNATIONAL FIELD OFFICES

AUSTRALIA	Tektronix Australia Pty. Limited, 4-14 Foster Street, Sydney, N.S.W. 2010 Telephone: 211-2666 Cable: TEKTRONIX AUSTRALIA Tektronix Australia Pty. Limited, Suite 20, 67 Queen's Road, Melbourne, Victoria 3004 .. Telephone: 51-1592 Tektronix Australia Pty. Limited, 128 Gilles Street, Adelaide, South Australia 5000 .. Telephone: 23-2811
CANADA	Tektronix Canada Ltd., 5050 de Sorel Street, Montreal 9, Quebec Telephone: (514) 731-3761 Telex: 01-2867 ... Cable: TEKANADA Tektronix Canada Ltd., 28A Northside Road, Bells Corners, Ottawa 6, Ontario ... Telephone: (613) 828-5171 Telex: 01-3419 Tektronix Canada Ltd., 1177 Finch Avenue West, Downsview, Ontario ... Telephone: Toronto (416) 638-6404 Telex: 02-2776 Tektronix Canada Ltd., 2180 West Broadway, Vancouver, British Columbia .. Telephone: (604) 736-0265 Telex: 04-50262
FRANCE	Relations Techniques Intercontinentales, 134, Avenue de Malakoff, Paris XVI Telex: 25.002 ... Cable: RELATEK, Paris ... Telephone: 727-49.09 & 727-08.36 Relations Techniques Intercontinentales, Centre Regional de Lyon, 166, Avenue Berthelot (69) Lyon 7° Telephone: (78) 72.00.70 Relations Techniques Intercontinentales, Centre Regional de Nice, 11, Avenue Valdiletta, (6) Nice Telephone: (93) 84.05.93 Relations Techniques Intercontinentales, Centre Regional de Rennes, 6, Avenue Barthou, (35) Rennes Telephone: (99) 00.84.42 Relations Techniques Intercontinentales, Centre Regional de Toulouse, 15, rue Joseph Vie, (31) Toulouse Telephone: (61) 42.04.50
JAPAN	Sony/Tektronix Corporation, P. O. Box 14, Haneda Airport, Tokyo Telephone: 493-3311 Telex: 2262 or 2436 (Area 03/Tokyo)
SWITZERLAND	Tektronix International A.G., Alpenstrasse No. 9, 6300 Zug (P. O. Box 57, CH-6301 Zug) Telex: 78808 ... Cable: TEKINTAG ... Telephone: 042 49192
UNITED KINGDOM	Tektronix U.K. Ltd., Beaverton House, Station Approach, Harpenden, Herts Telex No. 25559...Cable: TEKTRONIX HARPENDEN...Telephone: Harpenden 61251

INTERNATIONAL DISTRIBUTORS

SUPPLIED AND SUPPORTED BY TEKTRONIX, INC., P.O. BOX, 500, BEAVERTON, OREGON, U.S.A. 97005
Telephone: (503)644-0161 Telex: 036-691 Cable: TEKTRONIX

ARGENTINA	Coasin S.A., Virrey del Pino 4071, Buenos Aires ... Telex: 012-2284 Telephone: 52-3185 Cable: COASIN, Buenos Aires
BRASIL	Importação Industria E Comércio Ambriex, S.A., Av. Graça Aranha 226-6°, Rio de Janeiro, ZC-00 Cable: RAIOCARDIO Rio de Janeiro ... Telephone: 42-7990 & 42-7291 Importação Industria E Comércio Ambriex, S.A., Av. Pacaembu, 811 São Paulo ... Telephone: 37-7611
CHILE	Pentz y Cia., Ltda., Casilla 2839, Santiago Cable: PETIER Santiago .. Telephone: 63010
COLOMBIA	Manuel Trujillo Venegas e Hijo Ltda., Calle 54 #9-33 Apto. 102, Apartado Aéreo No. 20702, Bogotá 2, D.E. Cable: TRUVEHIJO Telephone: 48-57-72
HONG KONG	Intronics Limited, 4 Hankow Road, Suite 4A, Kowloon, Hong Kong Telephone: 672141 Cable: INTRONICS Hong Kong
INDIA	Hinditron Services Private Limited, Manesha, 69/A Nepean Sea Road, Bombay 6 Telex: 594 Cable: TEKHIND (BOMBAY)
MEXICO	Fredin S.A., Melchor Ocampo No. 212-505, Mexico 5, D.F., (P. O. Box 53-958, Mexico 17, D.F.) Telephone: 46-44-21
NEW ZEALAND	W & K McLean, Ltd., P. O. Box 3097, 103-105 Felton Mathew Avenue, Glen Innes, Auckland Cable: KOSFY Auckland Telephone: 34-541
PAKISTAN	Pak-Land Corporation, Central Commercial Area, Iqbal Road, P.E.C.H. Society, Karachi 29 Cable: PAKLAND Pakistan Telephone: 47315
PERU	Importaciones y Representaciones Electronicas, S.A., Franklin D. Roosevelt 105, Lima .. Telephone: 72076 Cable: IREING, Lima
URUGUAY	Compañía Uruguaya De Rayos X y Electromedicina S.A., Mercedes 1300, Yaguaron 1449, Montevideo Cable: CURZRAY, Montevideo Telephone: 8 58 29
VENEZUELA	Tecnica Nuclear de Venezuela, C.A., (Apartado Del Este 10.507) Plaza Morelos Edificio Eso, Caracas.... Cable: TECNUC Caracas Telephone: 54-39-56



INTERNATIONAL DISTRIBUTORS

INTERNATIONAL DISTRIBUTORS

SUPPLIED AND SUPPORTED BY TEKTRONIX LIMITED, P.O. Box 36, ST. PETER PORT, GUERNSEY, CHANNEL ISLANDS
Telephone: Guernsey 23411, Telex: 41193

Tektronix Limited maintains a warehouse of United States-made instruments, accessories and parts on the Island of Guernsey to quickly support these distributors in filling customer orders. Technical support of customers and distributors is also available from this facility. In addition, Tektronix has manufacturing facilities within the European Economic Community and European Free Trade Association.

ANGOLA	Equipamentos Tecnicos, Lda., Rua Serpa Pinto 39, Caixa Postal 6319, Luanda ... Telephone: Luanda 6917 Cable: EQUIPAL Luanda
AUSTRIA	Inglomark Markowitsch & Co., Mariahilfer Strasse 133, Wien 15 Telephone: (0222) 83-05-08 Telex: (1) 1393... Cable: INGLOMARK Wien
BELGIUM	Régulation Mesure, SPRL, 22, Rue Saint-Hubert, Bruxelles 15..... Telephone: 71.20.20 Telex: 02-21520... Cable: MEREG Bruxelles
DENMARK	Tage Olsen A.S., 1, Ronnegade, Copenhagen O Telephone: (01) 29.48.00 Telex: 5788... Cable: TOCOPEN, Copenhagen
FINLAND	Into O/Y, P. O. Box 153, 11, Meritullinkatu, Helsinki Telephone: 11123 Cable: INTO, Helsinki
GREECE	Marios Dalleggio Representations, 2, Alopekis Street, Athens 139 Telephone: 710.669 Cable: DALMAR Athens
ISRAEL	Eastronics Limited, 75 Haifa Road, (P.O. Box 21029) Tel Aviv Telephone: 446060 Telex: 033-638... Cable: EASTRONIX Tel Aviv
ITALY	Silverstar Ltd., Via Dei Gracchi N20, Milano Telephone: 469.6551, 2, 3, 4, 5 Cable: SILVERSTAR, Milano
	Silverstar Ltd., Via Paisiello N.30, Roma ... Cable: SILVERSTAR, Roma ... Telephone: 855.366 & 869.009
	Silverstar Ltd., Via Castelfidardo N.21, Torino Telephone: 400.75 & 435.27 Cable: SILVERSTAR, Torino
LEBANON	Projects, P. O. Box 5281, Beirut Cable: PROJECTS Beirut ... Telephone: 241200
MOZAMBIQUE	Equipamentos Tecnicos, Lda, Av. 24 de Julho, 1847, Lourenco Marques Telephone: 2601 Cable: EQUIPAL Lourenco Marques
The NETHERLANDS	C. N. Rood, N. V., 13, Cort van der Lindenstraat, P. O. Box 4542, Rijswijk Telex: 31238 ... Cable: ROODHOLLAND G.V. ... Telephone: The Hague 98.51.53
NORWAY	Morgenstjerne & Co. A/S, Wesselsgt 6, Oslo 1 Telephone: 20-16-35 Telex: 1719 ... Cable: MOROF Oslo
PORTUGAL	Equipamentos de Laboratorio Lda, Rue Pedro Nunes 47, Lisboa 1 Telephone: 73.34.36 & 73.34.37 Cable: EQUILAB, Lisboa
REPUBLIC OF SOUTH AFRICA	Protea Physical & Nuclear Instrumentation (Pty) Ltd., Wemmer, Johannesburg Telephone: 838-8351 Telex: J7337 ... Cable: MANLU
SPAIN	Carlos Rafael Marés, S.L., Valencia 333, Barcelona (9) Telephone: 257.62.00 Telex: 54676 ... Cable: SERAM Barcelona
	Carlos Rafael Marés, S.L., Gaztambide, 54-1°, Madrid (15) Telephone: 243-08-38 Cable: SERAM Madrid
SWEDEN	Erik Ferner, A.B., Snormakarvagen 35, Box 56, Bromma Telephone: 08/252870 Telex: 10312 ... Cable: SCIENTRON, Stockholm
	Erik Ferner, A.B., O. Annebergsvagen 19, Box 30, Partille, Goteborg Telephone: 031-444130
TURKEY	M. Suheyl Erkman, Necatibey Cad No. 207, Galata, Istanbul Telephone: 441546 Cable: INGMESUER Istanbul
WEST GERMANY	Rohde & Schwarz Handels-GmbH, 1000 Berlin 10, Ernst-Reuter-Platz 10 Telephone: 34 05 36 Telex: 0 181 636 ... Cable: ROHDESCHWARZ Berlin
	Rohde & Schwarz Vertriebs-GmbH, 7500 Karlsruhe, Kreisstrasse 39 Telephone: 2 39 77 Telex: 7 826 730 ... Cable: ROHDESCHWARZ Karlsruhe
	Rohde & Schwarz Vertriebs-GmbH, 2000 Hamburg 50, Grosse Bergstrasse 213-217 ... Telephone: 38 14 66 Telex: 0 213 749 ... Cable: ROHDESCHWARZ Hamburg
	Rohde & Schwarz Vertriebs-GmbH, 5000 Koeln, Hohe Strasse 160-168 Telephone: 23 30 06 Telex: 08 882 917 ... Cable: ROHDESCHWARZ Koeln
	Rohde & Schwarz Vertriebs-GmbH, 8000 München, Dachauer Strasse 109 Telephone: 52 10 41 Telex: 0 522 953 ... Cable: ROHDESCHWARZVERTRIEB München



GENERAL AND ORDERING INFORMATION

CUSTOMERS OUTSIDE THE UNITED STATES

To provide you with personal assistance in ordering as well as servicing Tektronix instruments, we have established Field Engineering Offices and technically qualified Tektronix distributors in many countries throughout the world. The Tektronix office or distributor in your country will be pleased to help you select the instrument that best suits your requirements in performance, and provide you with prompt ordering service.

SERVICE

If you require service, replacement parts, a warranty question resolved, or other help, please notify the Tektronix facility through which you ordered your instrument. They will process all orders for repair parts promptly, and provide emergency parts service when needed to restore an instrument to operating condition. They will also arrange for fast service with necessary recalibration or repair work on your instrument.

COUNTRIES WITH TEKTRONIX FIELD ENGINEERING OFFICES

AUSTRALIA
CANADA
FRANCE
JAPAN
SWITZERLAND
UNITED KINGDOM
Listed on page 12

The Tektronix Field Engineering office in your country will provide you with quotations and accept your orders. Normally, prices quoted are FOB your plant.

WARRANTY

All Tektronix instruments are warranted against defective material and workmanship for one year from date of shipment. Tektronix transformers, manufactured in our own plant, are warranted for the life of the instrument.

PLEASE DO NOT RETURN INSTRUMENTS OR PARTS BEFORE RECEIVING DIRECTIONS.

COUNTRIES WITH TEKTRONIX DISTRIBUTORS

Listed on pages 12 and 13

Your Tektronix distributor will provide you with quotations FOB your country and accept your orders.

COUNTRIES WITH NO TEKTRONIX DISTRIBUTOR OR TEKTRONIX FIELD ENGINEERING OFFICE

Please address your inquiries and orders to:

Tektronix, Inc.
International Marketing Dept.
P. O. Box 500
Beaverton, Oregon, USA 97005

INFORMATION AND QUOTATIONS

Staff Field Engineers will be pleased to provide you with information on Tektronix instruments and answer your technical questions. A pro forma invoice will be issued, if requested, indicating price and sales conditions. When pro forma invoice or purchase order acknowledgement is issued, we will indicate the documents needed to ship your order. We will be glad to prepare necessary export documentation for you and make all shipping arrangements.

METHOD OF PAYMENT

We would like to make our products available to customers on open account terms, whenever conditions permit. Other credit terms are available for a customer's particular requirements. However, due to political, foreign exchange, and regulatory conditions in many areas of the world, credit terms are not always available. In those cases, advance payment or irrevocable letters of credit are required.

SHIPMENTS

Unless otherwise requested, shipments will be made by the most economical method.



UNITED STATES FIELD ENGINEERING OFFICES

TEKTRONIX, INC.

Tektronix, Inc., an Oregon Corporation, Home Office & Factory, P. O. Box 500, Beaverton, Oregon 97005
Telephone: (503) 644-0161 TWX—503-291-6805 Telex: 036-691 Cable: TEKTRONIX

FIELD ENGINEERING OFFICES

- ALABAMA** Huntsville... 3322 South Memorial Parkway, Suite 27, Huntsville 35801
Telex 05-9422 ... Telephone: (205)881-2912
- ARIZONA** Phoenix... 7045 E. Camelback Road, Scottsdale 85251...Telex 066-701 ... Telephone: (602)946-4273
Tucson Area: Enterprise 383
- CALIFORNIA**
- San Diego... Suite 107, 6150 Mission Gorge Road, San Diego 92120
Telex 069-525 ... Telephone: (714)283-6225
 - *Orange Area*... 1722 E. Rose Avenue, Orange 92667...Telex 6-78432 ... Telephone: (714)633-3450
 - *Alhambra Area*... 1525 S. Garfield Avenue, Suite D, Alhambra 91801
Telex: 6-74397 ... Telephone: (213)576-1601
From L.A. call: 283-0501
 - *Santa Barbara Area*... 1310 Santa Barbara Street, Santa Barbara 93104
Telex 658-411 ... Telephone: (805)963-1848
Island of Oahu, Hawaii Area: ENterprise 5-700
 - *Van Nuys Area*... 16930 Sherman Way, Van Nuys 91406...Telex 06-74396 ... Telephone: (213)987-2600
From Los Angeles telephones: 873-6868
 - *Walnut Creek Area*... 1709 Mt. Diablo Blvd., Walnut Creek 94596...Telex 033-644 ... Telephone: (415) 935-6101
From Oakland, Berkeley, Richmond, Albany and San Leandro: 254-5353
 - *Palo Alto Area*... 3750 Fabian Way, Palo Alto 94303...Telex 34-8411 ... Telephone: (415)326-8500
- COLORADO** Denver... 2120 South Ash Street, Denver 80222...Telex 045-662 ... Telephone: (303)757-1249
- CONNECTICUT** Hartford... 809 Main Street, East Hartford 06108 ... Telephone: (203)289-8695
- FLORIDA** Stamford... 125 Strawberry Hill Avenue, Stamford 06902...Telex 096-5917 ... Telephone: (203)325-3817
- Orlando... Suite 185, 1010 Executive Center Drive, Orlando 32803
Telex 56-4465 ... Telephone: (305)841-2382
From The Cape Kennedy Area: 636-0343
- GEORGIA** Atlanta... Suite 106, 1680 Tullie Circle, N.E., Atlanta 30329...Telex 05-42233 ... Telephone: (404)633-0344
- ILLINOIS** Chicago... 400 Higgins Road, Park Ridge 60068...Telex 02-53374 ... Telephone: (312)825-6666
119 East Ogden Avenue, Suite 111, Hinsdale 60521 .. Telex 02-53694 .. Telephone: (312)325-3050
- INDIANA** Indianapolis... 3937 North Keystone Avenue, Indianapolis 46205...Telex 027-348
Telephone: (317)546-2408
- KANSAS** Kansas City... 5845 Horton, Suite 106, Mission 66202...Telex 04-2321 ... Telephone: (913)HEDrick 2-1003
- MARYLAND** Baltimore... 1045 Taylor Avenue, Towson 21204...Telex 087-804 ... Telephone: (301)825-9000
From Harrisburg, Lancaster and York Area call ENterprise 1-0631
- Rockville... 1500 East Jefferson Street, Rockville 20852...Telex 89-2337 ... Telephone: (301)427-0700
 - Boston... 244 Second Avenue, Waltham 02154...Telex 094-6301 ... Telephone: (617)894-4550
- MASSACHUSETTS** Detroit... 22132 West Nine Mile Road, P. O. Box 363, Southfield 48075
Telex 023-400 ... Telephone: (313)358-3122
- MICHIGAN** Minneapolis... Suite 115, 7515 Wayzata Boulevard, Minneapolis 55426
Telex 029-699... Telephone: (612) 545-2581
- MINNESOTA** St. Paul... Pentagon Office Park, 4930 West 77th Street, Edina 55435 ... Telephone: (612)920 1860
Telex 29-5393
- MISSOURI** St. Louis... 119 North Harvey, St. Louis 63135...Telex: 044-851 ... Telephone: (314) Jackson 4-0900
- NEW JERSEY** Cherry Hill... 909 Kings Highway North, Cherry Hill 08034...Telex 84-5338... Telephone: (609)667-4333
- Springfield... 964 South Springfield Avenue, Springfield 07081...Telex 1-26344 ... Telephone: (201)379-1670
 - Albuquerque... 1258 Ortiz Drive, S.E., Albuquerque 87108...Telex 074-6421 ... Telephone: (505)268-3373
Southern New Mexico Area: Enterprise 678
- NEW MEXICO** Buffalo... 965 Maryvale Drive, Buffalo 14225... Telex 091-385 ... Telephone: (716) 633-7861
- Endicott... 3214 Watson Blvd., Endwell 13763...Telex 093-319 ... Telephone: (607)Pioneer 8-8291
 - Poughkeepsie... 12 Raymond Ave., Poughkeepsie 12603...Telex 96-816 ... Telephone: (914)471-3620
 - Syracuse... East Molloy Road & Pickard Drive, P.O. Box 155, Syracuse 13211
Telex 093-739 ... Telephone: (315)455-6666
- NEW YORK** New York City and Long Island... 125 Mineola Avenue, Roslyn Heights, L. I., N. Y. 11577
Telex: ROSN 01-26446 ... Telephone: (516)HT 4-2300
- Northern N.J... 964 South Springfield Avenue, Springfield, New Jersey 07081...Telex 1-26344
Telephone: (201)379-1670
 - Hudson River Valley, Westchester County, Connecticut... 125 Strawberry Hill Ave., Stamford, Connecticut 06902
Telex: 096-5917 ... Telephone: (203)325-3817
- NORTH CAROLINA** Greensboro... 1011 Homeland Avenue, Greensboro 27405...Telex 57-4416 ... Telephone: (919)274-4647
- OHIO** Cleveland... 5562 Pearl Road, Suite 101, Cleveland 44129...Telex 098-5217 ... Telephone: (216)884-6558
Columbus... 12 West Selby Blvd., Suite 5, Worthington 43085
Telex: WOGN 024-684 ... Telephone: (614)888-4040
- PENNSYLVANIA** Dayton... 3309 Office Park Drive, Dayton 45439...Telex 02-88225 ... Telephone: (513)293-4175
- Philadelphia... 126 Presidential Blvd. North, Bala-Cynwyd 19004...Telex 083-4218
Telephone: (215)TEnnyson 9-3111
 - Pittsburgh... 3834 Northern Pike, Monroeville 15146...Telex 086-761 ... Telephone: (412)351-3345
- North Central Area—contact our Endicott, New York Office*
South Central Area—contact our Baltimore, Maryland Office
- TEXAS** Dallas... 2600 Stemmons Freeway, Suite 162, Dallas 75207...Telex 073-2217
Telephone: (214)MEIrose 1-4560
- Houston... 3723 Westheimer, Suite H, Houston 77027...Telex 077-494 ... Telephone: (713)NAtional 2-8141
New Orleans, Louisiana Area: WX 3093
 - San Antonio... 8031 Broadway, San Antonio 78209...Telex: 76-7456 ... Telephone: (512)TAylor 6-0686
 - Salt Lake City... 65 West 2950 South, Salt Lake City 84115 ... Telephone: (801)484-8501
- UTAH** Alexandria... Suite 102, 201 Lincolnia Road, Alexandria 22304...Telex 8-9406 ... Telephone: (703)751-6096
- VIRGINIA** Newport News... 618C Dresden Drive, Newport News 23601...Telex 82-3409 ... Telephone: (703)595-3301
- WASHINGTON** Seattle... 410 Baker Boulevard, Andover Industrial Park, Seattle 98188
Telex 032-488 ... Telephone: (206)CHerry 3-2494
From Portland, Corvallis, Eugene (Oregon): Commerce 9369
From Pullman, Richland, Spokane, Yakima: Zenith 9369
- WISCONSIN** Milwaukee... Mayfair Plaza, 2421 North Mayfair Road, Milwaukee 53226
Telex: 2-6604 ... Telephone: (414)476-6850

• Also Service Center

Area Code Numbers are in parenthesis preceding telephone number.

Instrument Dimensions

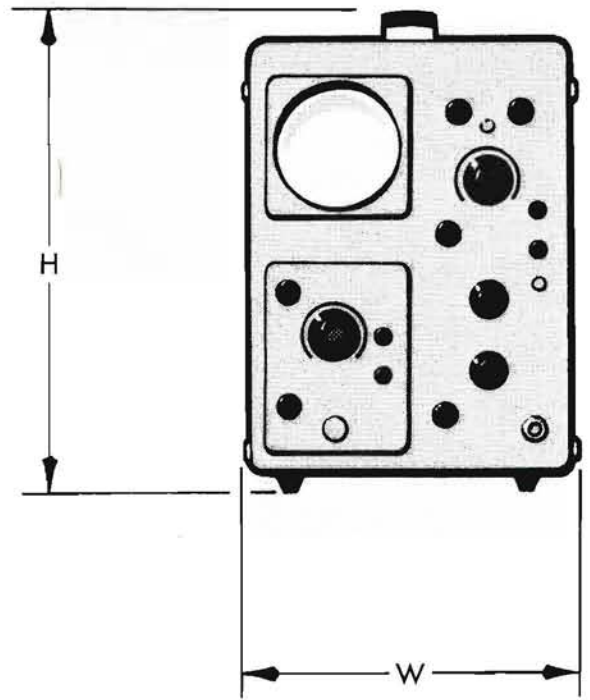
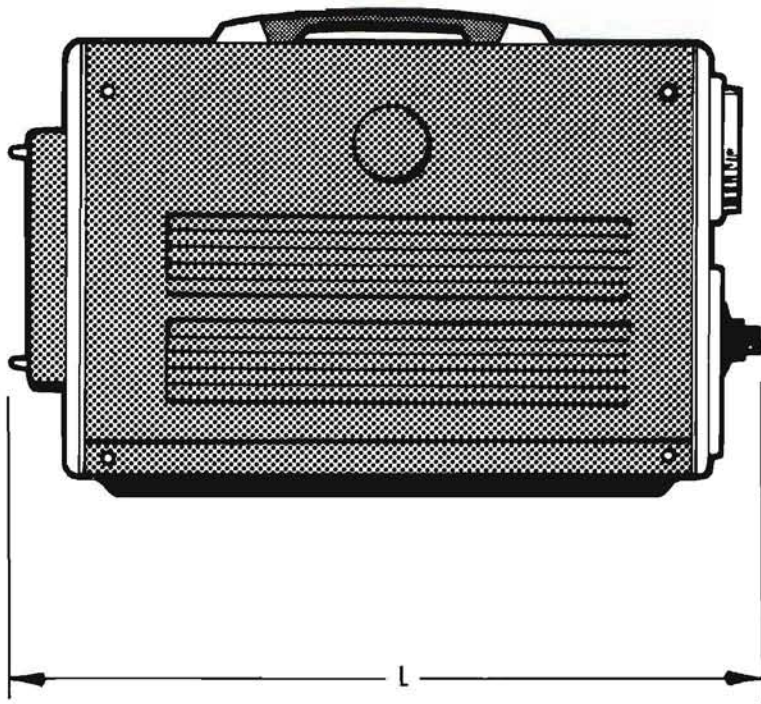

CABINET MODEL INSTRUMENTS		
Symbol	Description	Definition
H	Height	Bottom of feet or rails to top of handle (resting down).
W	Width	Overall width including latch mounting.
L*	Length	Front of front protrusion to greatest rear permanent protrusion, excluding cables.

* Note: Plug-in units could change dimension "L".

Instrument Dimensions

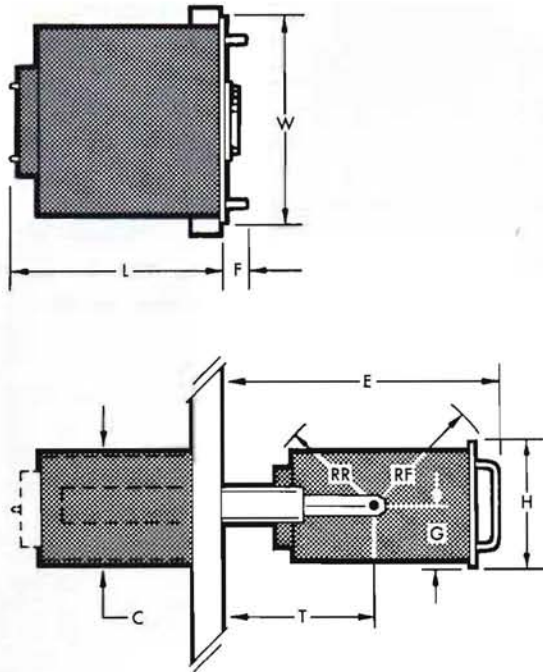

RACK MOUNT INSTRUMENTS		
EXCLUSIVE OF PLUG-IN UNITS AND PROBES		
Symbol	Description	Definition
H	Height	Height of front panel.
W*	Width	Width of front panel.
L	Length	Rack front to rearmost permanent fixture, excluding cables.
F	Forward Clearance	Back of front panel to foremost protrusion.
G	Vertical Axis	Bottom of front panel to horizontal plane of rotation.
E	Extended Inst.	Maximum forward clearance with instrument out and horizontal.
RF	Radius — front	Front radius of rotation.
RR	Radius — rear	Rear radius of rotation.
T	Track	Rack front to pivot point.
C	Cabinet	Cabinet height.

* Note: Instruments mount to a standard 19-inch wide rack.

These instruments mount with sliding tracks in a cabinet that mounts to a standard 19 in wide rack.

These instruments mount with sliding tracks to a standard 19 in wide rack. Rear support for sliding tracks is required, such as an enclosed rack.

These instruments bolt directly to a standard 19 in wide rack. They can be ordered at additional cost, with tilt-lock, sliding tracks. Rear support for tracks is required.

TYPE	MOUNTING DIMENSIONS																				
	H		L		F		G		E		RF		RR		T		C				
	in	cm	in	cm	in	cm	in	cm	in	cm	in	cm	in	cm	in	cm	in	cm			
RM15	8 ³ / ₄	22.2	22 ¹ / ₁₆	57.6	1 ³ / ₄	4.5	2 ³ / ₈	6.1	29 ¹ / ₁₆	75.4	13 ¹ / ₁₆	34.8	12 ³ / ₈	31.4	16 ¹ / ₂	41.9	8 ¹ / ₂	21.6			
RM17	7	17.8	18 ⁷ / ₈	46.0	1 ³ / ₄	4.5	2 ³ / ₈	7.3	29 ¹ / ₁₆	53.8	12 ⁷ / ₁₆	31.8	8 ⁵ / ₁₆	21.1	9 ¹ / ₈	23.2	6 ³ / ₁₆	17.3			
RM31A, RM35A	14	35.6	22 ¹ / ₁₆	57.6	2	5.1	6 ¹ / ₂	17.8	29 ¹ / ₁₆	74.7	14 ¹ / ₁₆	35.7	12 ⁷ / ₁₆	31.9	16 ¹ / ₄	41.3	13 ¹ / ₁₆	35.1			
RM122	5 ¹ / ₄	13.3	6	15.2	1 ⁵ / ₁₆	2.4												4	10.2		
RM125	5 ¹ / ₄	13.3	13 ⁹ / ₁₆	34.5	7 ⁷ / ₈	2.2													4 ¹ / ₁₆	10.3	
RM502A	12 ¹ / ₄	31.1	22 ³ / ₄	57.8	1 ¹ / ₁₆	4.6	5 ⁷ / ₈	14.9	28 ¹ / ₄	71.7	15 ⁵ / ₈	39.7	10 ⁵ / ₁₆	26.2	13 ¹ / ₈	33.2	11 ¹ / ₄	28.6			
RM503, RM504	7	17.8	17	43.2	1 ³ / ₄	4.5	3 ¹ / ₂	8.9	22 ¹ / ₁₆	57.6	11 ¹ / ₁₆	30.3	7 ³ / ₄	19.7	11 ¹ / ₈	28.3	6 ⁷ / ₈	17.5			
RM529	5 ¹ / ₄	13.3	18 ¹ / ₄	46.4	1 ³ / ₄	4.5	2 ³ / ₈	6.1	21 ¹ / ₄	54.0	12 ⁷ / ₈	30.8	8 ¹ / ₁₆	21.5	9 ³ / ₈	23.8	5 ⁵ / ₈	13.1			
RM543B, RM544 RM545B, RM546 RM547	14	35.6	22 ¹ / ₁₆	57.7	1 ⁵ / ₁₆	5.0	6 ¹ / ₁₆	17.3	28 ³ / ₄	33.0	13 ¹ / ₂	34.3	12 ⁵ / ₁₆	32.9	16 ¹ / ₄	41.3	13 ⁵ / ₁₆	35.4			
RM561A	7	17.8	18 ⁷ / ₁₆	46.9	1 ³ / ₄	4.5	2 ³ / ₈	6.1	24 ³ / ₁₆	60.8	13 ³ / ₄	34.9	7 ⁷ / ₈	20.0	11	27.9	6 ³ / ₄	17.2			
RM564	7	17.8	18 ⁷ / ₁₆	46.9	1 ³ / ₄	4.5	2 ³ / ₈	6.1	24 ³ / ₁₆	60.8	13 ³ / ₄	34.9	7 ⁷ / ₈	20.0	11	27.9	6 ³ / ₄	17.2			
RM565	12 ¹ / ₄	31.1	22 ³ / ₁₆	56.4	1 ¹ / ₁₆	4.6	2 ³ / ₈	6.1	30 ¹ / ₂	77.4	15 ⁷ / ₁₆	39.1	13 ¹ / ₁₆	33.2	16 ⁵ / ₈	42.2	12 ³ / ₁₆	31.0			
RM567	12 ¹ / ₄	31.1	22 ³ / ₁₆	56.4	1 ¹ / ₁₆	4.6	7 ⁷ / ₈	19.4	31 ¹ / ₁₆	80.1	16 ¹ / ₈	41.0	11 ¹ / ₁₆	28.3	16 ⁵ / ₈	42.2	14 ¹ / ₁₆	38.0			
RM585A	14	35.6	22 ¹ / ₁₆	57.7	2	5.1	6 ¹ / ₂	17.8	29 ¹ / ₁₆	74.7	14 ¹ / ₁₆	35.7	12 ⁷ / ₁₆	31.6	16 ¹ / ₄	41.3	13 ¹ / ₁₆	35.1			
R116	5 ¹ / ₄	13.3	17 ⁹ / ₁₆	44.6	1 ⁵ / ₈	4.1	1 ³ / ₄	4.5	25 ³ / ₄	65.4	11 ⁹ / ₁₆	29.4	8 ¹ / ₄	21.0	14 ⁵ / ₈	37.2	5 ¹ / ₁₆	12.8			
R230	7	17.8	21	53.3	3 ¹ / ₁₆	9.4	1 ³ / ₄	4.4	28 ⁵ / ₈	88.8	14 ⁷ / ₁₆	36.6	10 ¹ / ₁₆	25.8	15 ⁵ / ₈	23.6	7	17.8			
R293	3 ¹ / ₂	8.8	16 ³ / ₁₆	41.4	1 ⁷ / ₈	4.8	1 ³ / ₄	4.5	22 ¹ / ₁₆	56.4	9 ⁵ / ₈	24.5	8 ³ / ₁₆	20.8	12 ⁵ / ₈	32.1	3 ³ / ₈	8.6			
R422	7	17.8	12 ¹ / ₂	31.8	1 ¹ / ₁₆	4.6	3 ¹ / ₂	8.9	16 ⁵ / ₈	42.3								6 ³ / ₄	17.2		
R453	7	17.8	17 ³ / ₈	44.1	1 ¹ / ₁₆	4.6	3 ¹ / ₂	8.9	20 ¹ / ₁₆	52.6	11 ⁵ / ₈	29.5	7 ⁷ / ₈	20.0	9 ⁵ / ₁₆	23.7	6 ³ / ₄	17.2			
R454	7	17.8	17 ³ / ₈	44.1	1 ¹ / ₁₆	4.6	3 ¹ / ₂	8.9	20 ¹ / ₁₆	52.6	11 ⁵ / ₈	29.5	7 ⁷ / ₈	20.0	9 ⁵ / ₁₆	23.7	6 ³ / ₄	17.2			
R491	7	17.8	17 ³ / ₈	44.2	2 ¹ / ₁₆	5.2	3 ¹ / ₂	8.9	21 ¹ / ₁₆	53.5	11 ¹ / ₁₆	30.4	8 ¹ / ₂	21.6	9 ³ / ₁₆	23.7	6 ¹ / ₁₆	17.3			
R520	7	17.8	17 ³ / ₄	44.8	2	5.1															
R556	14	35.6	22 ¹ / ₁₆	57.9	1 ³ / ₄	4.5	8 ¹ / ₈	20.7	30 ⁵ / ₁₆	77.0	13 ¹ / ₈	33.3	14 ¹ / ₄	36.2	18 ¹ / ₂	57.0	13 ³ / ₈	35.3			
R568	7	17.8	21	53.3	3 ¹ / ₁₆	9.4	1 ³ / ₄	4.4	28 ⁵ / ₈	88.8	14 ⁷ / ₁₆	36.6	10 ¹ / ₁₆	25.8	15 ⁵ / ₈	23.6	7	17.8			
R647A	7	17.8	19	48.3	1 ¹ / ₁₆	4.3	2 ¹ / ₁₆	6.2	27 ⁵ / ₁₆	70.9	13 ³ / ₈	34.5	8 ¹ / ₁₆	22.1	16 ³ / ₈	41.6	13 ³ / ₈	35.2			
127	8 ³ / ₄	22.2	21 ⁵ / ₈	55.0	1 ³ / ₄	4.5	2 ³ / ₈	6.1	28 ¹ / ₁₆	72.9	12 ³ / ₄	32.4	12 ¹ / ₄	31.1	16 ¹ / ₂	41.9	8 ¹ / ₂	21.6			
129	10 ¹ / ₂	26.6	21 ⁵ / ₈	55.0	2	5.1	1 ³ / ₄	4.5	29 ¹ / ₂	74.9	17 ⁵ / ₈	44.8	11 ¹ / ₁₆	28.3	13 ¹ / ₄	33.7	10 ¹ / ₂	26.8			
262	5 ¹ / ₄	13.3	17 ⁹ / ₁₆	44.6	1 ⁵ / ₈	4.1	1 ³ / ₄	4.5	20 ³ / ₄	52.7	11 ⁹ / ₁₆	29.4	8 ¹ / ₄	21.0	14 ⁵ / ₈	37.2	5 ¹ / ₁₆	12.9			
016-0086-01	5 ¹ / ₄	13.3	17 ⁵ / ₁₆	45.6	3 ⁷ / ₈	1.0													5 ⁹ / ₁₆	13.8	
437-0031-00	8 ³ / ₄	22.2	9 ¹ / ₁₆	24.6	1 ¹ / ₄	0.7														7 ¹ / ₁₆	18.0
437-0071-00	6 ¹ / ₁₆	17.0	13 ³ / ₈	34.0	1 ¹ / ₁₆	5.0														6 ¹ / ₁₆	16.8

Shipping Volumes

Type	Domestic Pack Volume Cu/ft	Export Pack Volume Cu/ft
B	0.9	1.5
CA	0.9	1.5
C-12	2.1	4.8
C-27	2.1	4.8
C-30	0.9	2.1
C-40	0.9	2.1
D	0.9	1.5
E	0.9	1.5
FM122	0.8	1.5
FM125	1.3	4.8
G	0.9	1.5
H	0.9	1.5
K	0.9	1.5
L	0.9	1.5
M	0.9	1.5
O	0.9	1.5
Q	0.9	1.5
RM15	5.2	9.9
RM17	5.2	9.9
RM31A	6.7	9.9
RM35A	6.7	9.9
RM122	1.9	3.1
RM125	3.5	5.6
RM502A	6.7	9.9
RM503	5.2	9.9
RM504	5.2	9.9
RM529	5.2	9.9
RM543B	6.7	9.9
RM544	6.7	9.9
RM545B	6.7	9.9
RM546	6.7	9.9
RM547	6.7	9.9
RM561A	5.2	9.9
RM564	5.2	9.9
RM565	6.7	9.9
RM567	6.7	9.9
RM585A	6.7	9.9
R116	5.2	9.9
R230	5.2	9.9
R283	2.4	3.6
R293	5.2	9.9
R422	5.2	9.9
R422150B	5.2	9.9
R422150E	5.2	9.9
R453	5.2	9.9
R454	5.2	9.9
R491	5.2	9.9
R556	10.3	11.2
R568	5.2	9.9
R647A	5.2	9.9

Type	Domestic Pack Volume Cu/ft	Export Pack Volume Cu/ft
T	0.9	1.5
W	0.9	1.5
Z	0.9	1.5
1A1	0.9	1.5
1A2	0.9	1.5
1A4	0.9	1.5
1A5	0.9	1.5
1A6	0.9	1.5
1A7A	0.9	1.5
1L5	1.2	2.1
1L10	1.2	2.1
1L20	1.2	2.1
1L30	1.2	2.1
1S1	1.9	3.1
1S2	1.9	3.1
2A60	1.0	1.7
2A61	1.0	1.7
2A63	1.0	1.7
2B67	1.0	1.7
3A1	1.0	1.7
3A2	1.0	1.7
3A3	1.0	1.7
3A5	1.0	1.7
3A6	1.0	1.7
3A7	1.0	1.7
3A72	1.0	1.7
3A74	1.0	1.7
3A75	1.0	1.7
3A8	1.0	1.7
3B2	1.0	1.7
3B3	1.0	1.7
3B4	1.0	1.7
3B5	1.0	1.7
3C66	1.0	1.7
3L5	1.0	1.7
3L10	1.2	2.1
3S1	1.0	1.7
3S2	1.0	1.7
S1	0.3	1.3
S2	0.3	1.3
3S3	1.0	1.7
3T2	1.0	1.7
3T4	1.0	1.7
3T77A	1.0	1.7
4S1	1.9	3.1
4S2A	1.9	3.1
4S3	1.9	3.1
5T3	1.0	1.7
6R1A	2.4	3.6
10A1	1.0	1.7

Type	Domestic Pack Volume Cu/ft	Export Pack Volume Cu/ft
10A2A	1.0	1.7
11B1	1.0	1.7
11B2A	1.0	1.7
21A	1.0	1.7
22A	1.0	1.7
81A	1.0	1.7
82	0.9	1.5
86	0.9	1.5
106	1.3	3.1
109	1.3	3.1
111	1.2	2.1
113	4.7	6.8
114	1.3	2.5
122	0.8	1.5
125	1.3	4.8
127	5.4	9.9
129	6.7	9.9
130	1.2	2.1
132	1.9	3.1
133	1.9	3.1
160A	1.3	4.8
161	0.8	1.5
162	0.8	1.5
163	0.8	1.5
175	4.9	9.9
184	1.3	3.1
191	1.3	3.1
200-1		
200-2		
201-1	13.2	14.5
201-2	13.2	14.5
202-1	13.2	14.5
202-2	13.2	14.5
205-1	18.4	20.2
205-2	18.4	20.2
205-3	18.4	20.2
230	5.2	9.9
262	5.0	9.9
263	1.3	3.1
283	0.9	1.5
284	1.3	3.0
292	0.9	1.5
310A	1.9	3.1
317	2.4	3.6
321A		
wo bat	1.9	3.1
360	1.3	3.6
410	1.9	3.6

Type	Domestic Pack Volume Cu/ft	Export Pack Volume Cu/ft
422		
w cover	3.7	5.5
422125B		
wo bat	3.7	5.5
453		
w cover	3.7	5.5
454		
w cover	3.7	5.5
491		
w cover	3.7	5.5
502A	4.1	7.5
503	3.5	5.6
504	3.5	5.6
507	5.4	7.5
507 P.S.	3.5	5.6
515A	3.5	5.6
516	3.5	5.6
519	7.8	10.4
520 NTSC	5.2	9.3
520 PAL	5.2	9.3
52	2.4	5.6
531A	5.4	7.5
533A	5.4	7.5
535A	5.4	7.5
536	5.4	7.5
543B	5.4	7.5
544	5.4	7.5
545B	5.4	7.5
546	5.4	7.5
547	5.4	7.5
549	5.4	7.5
551	5.4	7.5
551 P.S.	3.5	5.6
555	6.4	9.2
555 P.S.	3.5	5.6
556	10.3	11.2
561A	3.5	5.6
564	3.5	5.6
565	6.7	9.9
567	6.7	9.9
568	5.2	9.9
575	5.4	7.5
575122C	5.4	7.5
581A	5.4	7.5
585A	5.4	7.5
601	1.9	3.6
611	5.5	7.5
647A	3.5	5.6
661	5.4	7.5
1121	1.9	3.1

Symbols and Abbreviations

The user of this catalog may find some unfamiliar symbols and abbreviations. In general, Tektronix has adopted the Symbols For Units, IEEE Standard Number 260, dated January 15, 1965. The abbreviations have been adopted by Tektronix following a thorough study of available abbreviations and guidelines published by the National Bureau of Standards, United States Government, American Standards Association, and others.

Many of these symbols and abbreviations are new, and inconsistencies between this list and other sources such as instrument panels and existing instrument manuals will be found. Future instruments and manuals will reflect adherence to these new symbols and abbreviations.

Below are some of the symbols and abbreviations used in this catalog. Those symbols found in IEEE Standard Number 260 are marked with an asterisk.

alternating current	AC	giga	G	ohm	Ω
*ampere	A	*gigahertz	GHz	operational amplifier	op amp
amplitude modulation	AM	graticule	grat	oscilloscope	scope or CRO
approximate	approx	gravity unit	g		
approximately equal to	\approx or \cong	greater than	$>$	pair	pr
attenuation	atten	greater than or equal to	\geq	parts per million	P/M
audio frequency	AF	ground	gnd	peak to peak	P-P
automatic	auto			per	/
		*henry	H	*pico	p
bandwidth	bw	*hertz	Hz	*picoampere	pA
base	b	*hour	h	*picofarad	pF
*bel	B	impedance	Z	*picosecond	ps
		*inch	in	plus	+
calibrate	cal	inductance	L	plus and minus	+ and -
cathode-ray oscilloscope	CRO or scope	intermediate frequency	IF	plus or minus	\pm
cathode-ray tube	CRT			positive	pos
*centimeter	cm	kilo	k	pulse per second	p/s
clockwise	cw	*kilogram	kg	pulse-repetition rate	PRR
common-mode rejection	CMR	*kilohertz	kHz	pulse width	PW or t_p
common-mode rejection ratio	CMRR	kilohm	k Ω		
continuous wave	CW	kilometer	km	radio-frequency interference	RFI
counterclockwise	ccw	*kilovolt	kV	resistance	R
current	I			resistance-capacitance	RC
		less than	$<$	resistance-inductance	RL
*decibel	dB	less than or equal to	\leq	*revolution per minute	r/min
*decibel referred to one milliwatt	dBm	local oscillator	LO	risetime	t_r
deflection factor	DF	low frequency	LF	root mean square	RMS
*degree	$^\circ$	maximum	max		
*degree Celsius (centigrade)	$^\circ\text{C}$	mega	M	*second (time)	s
*degree Fahrenheit	$^\circ\text{F}$	*megahertz	MHz	serial number	SN
*degree Kelvin	$^\circ\text{K}$	*megohm	M Ω	signal	sig
delay	dly	*meter	m	signal-to-noise ratio	S/N
delay line	DL	micro	μ	standing-wave ratio	SWR
differential	diff	*microsecond	μs	storage time	t_s
direct current	DC	milli	m	sweep	swp
division	div	*millimeter	mm	synchronize	sync
		*millisecond	ms		
electromagnetic interference	EMI	*millivolt	mV	temperature	T
*farad	F	minus	-	time domain reflectometry	TDR
*foot	ft			tolerance	tol
*foot lambert	fL	nano	n	*volt	V
frequency modulation	FM	*nanosecond	ns		
		negative	neg	*watt	W

*IEEE Standard Number 260

Glossary of Terms

This glossary of oscilloscope terms is published to promote better communication through use of a common concept of terms.

Some of the terms are, in part, the result of work performed by the Subcommittee on Oscilloscopes, IEEE G-IM Committee on High Frequency Instruments.

The other terms have been recently adopted by Tektronix.

Accelerating Voltage—The cathode-to-viewing-area voltage applied to a cathode-ray tube for the purpose of accelerating the electron beam.

Alternate Operation—A means of displaying output signals of two or more channels by switching the channels, in sequence, after each sweep.

Astigmatism—In the viewing plane of the cathode-ray tube, any deviation of the indicating spot from a circular shape.

Bandwidth—A statement of the frequencies defining the upper and lower limits of a frequency spectrum where the amplitude response of an amplifier to a sinusoidal waveform becomes 0.707 (−3 dB) the amplitude of a reference frequency. When only one number appears, it is taken as the upper limit.

Beam Splitter—A device such as a prism or half-silvered mirror which splits a light beam into 2 or more beams not necessarily equal in intensity.

Bezel—The flange or cover used for holding an external graticule or CRT cover in front of the CRT in an oscilloscope. May also be used for mounting a trace recording camera or other accessory item.

Blanking—Extinguishing of the spot. Retrace Blanking is the extinction of the spot during the retrace portion of the sweep waveform. The term does not necessarily imply blanking during the holdoff interval or while waiting for a trigger in a triggered sweep system.

Brightness—The attribute of visual perception in accordance with which an area appears to emit more or less light. (See Luminance.)

Center Frequency (Radio Frequency or Intermediate Frequency)—That frequency which corresponds to the center of the reference coordinate.

Channel—A single path for transmitting electric signals, usually in distinction from other parallel paths.

Chopped Mode—A time-sharing method of displaying output signals of two or more channels with a single CRT gun, in sequence, at a rate not referenced to the sweep.

Chopping Rate—The rate at which channel switching occurs in Chopped Mode.

Chopping Transient Blanking—The process of blanking the indicating spot during the switching periods in Chopped Mode.

Common-Mode Rejection Ratio (CMRR)—The ratio of the deflection factor for a Common-Mode Signal to the deflection factor for a Differential Signal.

Common-Mode Signal—The instantaneous algebraic average of two signals applied to a balanced circuit, all signals referred to a common reference.

Contrast Ratio—The ratio of stored luminance to background luminance at a given operating voltage.

DC Balance—An adjustment of circuitry to avoid a change in DC level when changing gain.

DC Offset—A DC level which may be added to the input signal, referred to the input terminals.

DC Shift—An error in transient response with a time constant approaching several seconds.

Deflection Blanking—Blanking by means of a deflection structure in the CRT electron gun which traps the electron beam inside the gun to extinguish the spot, permitting blanking during retrace and between sweeps regardless of intensity setting.

Deflection Factor—The ratio of the input signal amplitude to the resultant displacement of the indicating spot. (e.g., volts/division.)

Delayed Sweep—1. A sweep that has been delayed either by a predetermined period or by a period determined by an additional independent variable. 2. Mode of operation of a sweep, as defined above.

Differential Amplifier—An amplifier whose output signal is proportional to the algebraic difference between two input signals.

Differential Signal—The instantaneous, algebraic difference between two signals.

Dispersion (Sweep Width)—The frequency sweep excursion over the frequency axis of the display. Can be expressed as frequency/full frequency axis or frequency (Hz)/div in a linear display.

Display Flatness—Uniformity of amplitude response over the rated maximum dispersion (usually in units of dB).

Dual-Beam Oscilloscope—An oscilloscope in which the cathode-ray tube produces two separate electron beams that may be individually or jointly controlled.

Dual-Trace—A mode of operation in which a single beam in a cathode-ray tube is shared by two signal channels. See Alternate Mode and Chopped Mode.

Dynamic Range, maximum useful—The ratio between the maximum input power and the spectrum analyzer sensitivity (usually in units of dB).

Dynamic Range, On Screen (Spectrum Analyzer)—The maximum ratio of signal amplitudes that can be simultaneously observed within the graticule (usually in units of dB).

Equivalent-Time Sampling—A sampling process in which at least one repetitive signal event is required for each sample taken. The time required for display construction is thus greater than the time represented in the display.

External Triggering—Introducing the Triggering Signal directly into the trigger circuit from an external source.

Flood Gun—A low-energy electron gun directing a large cone of electrons toward the entire storage target.

Fluorescence—Emission of light from a substance (a phosphor) during excitation by radiant energy.

Focus—The maximum convergence of the electron beam manifested by minimum spot size on the phosphor screen. (Note definition for Astigmatism.)

Glossary of Terms

Gaussian Response—A particular frequency response characteristic following the curve $y(f) = e^{-af^2}$. Typically, the frequency response approached by an amplifier having good transient response characteristics.

Graticule—A scale for measurement of quantities displayed on the cathode-ray tube of an oscilloscope.

Incidental Frequency Modulation (residual frequency modulation)—Short term frequency jitter or undesired frequency deviation caused by instabilities in the spectrum analyzer local oscillators. Incidental frequency modulation limits the usable resolution and dispersion (in units of Hz).

Information Writing Speed—The cathode-ray tube characteristic which is an indication of the maximum number of bits of information per second that can be photographically recorded and identified. Test conditions must be specified.

Input RC Characteristics—The DC resistance and capacitance to ground present at the input of an oscilloscope.

Intensity Modulation—The process and/or effect of varying the electron beam current in a cathode-ray tube resulting in varying brightness or luminance of the trace.

Internal Graticule—A graticule whose rulings are a permanent part of the inner surface of the cathode-ray tube faceplate.

Internal Triggering—The use of a portion of a deflection signal (usually the vertical deflection signal) as a triggering signal source.

Jitter—An aberration of a repetitive display indicating instability of the signal or of the oscilloscope. May be random or periodic, and is usually associated with the time axis.

Line Triggering—Triggering from the power-line frequency.

Logarithmic Display—A display in which the vertical deflection is a logarithmic function of the input signal voltage.

Luminance—The photometric equivalent of brightness.

Note: Luminance is recommended for the photometric quantity which has been called brightness. Use of this term permits brightness to be used entirely with reference to the sensory response. The photometric quantity has been confused often with the sensation merely because of the use of one name for two distinct ideas. Brightness will continue to be used properly in non-quantitative statements especially with reference to sensations and perceptions of light.

Magnified Sweep—A sweep whose time per division has been decreased by amplification of the sweep waveform rather than by changing the time constants used to generate it.

Oscillography—The art and practice of utilizing the oscillograph.

Oscilloscope—An oscillograph primarily intended for the immediate viewing of the graphic plot . . . most commonly used to denote a cathode-ray oscilloscope.

Overshoot—In the display of a step function (usually of time), that portion of the waveform which, immediately following the step, exceeds its nominal or final amplitude.

Parallax—The apparent displacement of an observed object due to the angle of observation.

Persistence—See Phosphor Decay.

Phase Lock—The synchronization of the local oscillator with a stable reference frequency.

Phosphor Decay—A phosphorescence curve, energy emitted versus time.

Phosphorescence—Emission of light from a substance after excitation has been removed.

Photographic Writing Speed—The maximum spot speed which produces a trace that can be photographically recorded without using film "fogging" techniques.

Postfogging—A technique of increasing the apparent sensitivity of film by a uniformly controlled exposure to light after the image producing exposure.

Prefogging—A technique of increasing the apparent sensitivity of film by a uniformly controlled exposure to light before the image producing exposure.

Preshoot—In the display of a step function (usually of time), that portion of the waveform which immediately precedes the step. Polarity of the excursion is usually but not necessarily opposite to that of the step which follows.

Random Sampling—A sampling process involving significant time-interval uncertainty between the signal and the sampling operation. Also the process of coherent display construction from such randomly-taken samples. May be employed by either real-time or equivalent-time sampling oscilloscopes.

Raster—A predetermined pattern of scanning lines which provides substantially uniform coverage of an area.

Real-Time Sampling—A sampling process in which more than one sample is taken for each signal event. The time required for display construction is the same as the time represented in the display.

Resolution (Cathode-Ray Tube)—A measure of the total number of trace lines discernible along the coordinate axes, bounded by the extremities of the graticule or other specific limits.

Resolution (Spectrum Analyzer)—The ability of the spectrum analyzer to display adjacent signal frequencies discretely. The measure of resolution is the frequency separation of two equal amplitude signals, the displays of which merge at the 3-dB down points (in units of Hz).

Ringling—An oscillatory transient occurring in the output of a system as a result of a suddenly applied change in input. Usually damped in time.

Risetime—The interval between the instants at which the instantaneous amplitude first reaches specified lower and upper limits. In the display of a step function of time, unless otherwise stated, these limits shall be 10% and 90% of the nominal or final amplitude of the step.

Rolloff—A gradually increasing loss or attenuation with increase or decrease of frequency beyond the substantially flat portion of the amplitude-frequency response characteristic of a system or transducer.

Rounding—In the display of a step function (usually of time), the loss of the corner following the step.

Sensitivity—Rating factor of spectrum analyzers ability to display signals.

1. Signal equals noise. That input signal level (usually in dBm) which results in a display where the signal level above the residual noise is equal to the residual noise level above the baseline; expressed as: signal + noise = twice noise.

2. Minimum discernible signal. That input signal level (usually in dBm) which results in a display where the signal is just distinguishable from the noise.

Glossary of Terms

Signal Delay—The transmission time of a signal through a network. The time is always finite, may be undesired, or may be purposely introduced.

Single Sweep—Operating mode for a triggered-sweep oscilloscope in which the sweep must be reset for each operation, thus preventing unwanted multiple display; particularly useful for trace photography. In the interval after the sweep is reset and before it is triggered it is said to be armed.

Spot—The illuminated spot that appears where the electron beam strikes the phosphor screen of a CRT.

Spot Size—See trace width.

Square Law Display—A display in which the vertical deflection is a linear function of the input signal power.

Stability—Property of retaining defined electrical characteristics for a prescribed period. Deviations from a stable state may be called *drift* or *jitter*. In triggered sweep systems, **triggering stability** may refer to the ability of the trigger and sweep system to maintain jitter-free display of high-frequency waveforms for relatively long (seconds to hours) periods of time. Also the name of the control used on some oscilloscopes to adjust the sweep for triggered, free running, or synchronized operation.

Stored Resolution—A measure of the tubes capability to display discrete elements of stored information usually defined by the number of line pairs resolvable per centimeter on the tube face.

Stored Writing Rate—The reciprocal of stored writing speed (seconds per centimeter or other units).

Stored Writing Speed—The speed (centimeters per second or other units) at which the writing beam will register stored information when scanning the storage target, under stated conditions of operation.

Sweep Accuracy—Accuracy of the trace horizontal (vertical) displacement compared with the reference independent variable, usually expressed in terms of average rate error as a percent of full scale. (See Sweep Linearity.)

Sweep Delay Accuracy—Accuracy of indicated sweep delay, usually specified in error terms.

Sweep Linearity—Maximum displacement error of the independent variable between specified points on the display area.

Sweep Lockout—Means for preventing multiple sweeps when operating in a single-sweep mode.

Sweep Magnifier—Circuit or control for expanding part of the sweep display. Sometimes known as sweep expander.

Sweep Range—The set of sweep time/division settings provided.

Sweep Reset—In oscilloscopes with single-sweep operation, the arming of the sweep generator to allow it to cycle once.

Sweep Switching (automatic)—Alternate display of two or more time bases or other sweeps using a single-beam CRT; comparable to dual- or multiple-trace operation of a deflection amplifier.

Sweep Time/Div—The nominal time required for the spot in the reference coordinate to move from one graticule division to the next. Also the name of the control used to select this time.

Synchronized Sweep—A sweep which would free-run in the absence of an applied signal but in the presence of the signal, is synchronized by it.

Tangential Noise Measurement—A procedure to determine displayed noise wherein a flat-top pulse or squarewave input signal is adjusted in amplitude until the two traces (or portions

of two traces) thus produced appear to be immediately adjacent or contiguous. Measurement of the resulting signal amplitude determines a noise value which bears a relationship to the value interpreted by the eye from a display.

Tilt—The slope associated with the flat portion of a nominally rectangular pulse of given time duration.

Time Domain Reflectometry—The technique of launching a pulse or step signal into a transmission medium with subsequent analysis of any reflections thus produced.

Trace Width—The distance between two points on opposite sides of a trace at which luminance is 50% of maximum. If the trace departs from a well-behaved (approximately Gaussian) form, it should be smoothed for the purpose of measurement.

Transient Response—Commonly, the characteristic response of a system to a unit step or unit impulse. Elements of transient response most commonly specified are: risetime, falltime, overshoot, undershoot, preshoot, and ringing.

Trigger—A pulse used to initiate some function (e.g., a Triggered Sweep or delay ramp). Where the terms Trigger and Triggering Signal are used together, Triggering Signal conventionally refers to a waveform applied to the triggering circuits and from which a trigger or trigger pulse is derived. Otherwise, Trigger may loosely refer to a waveform of any shape used as a signal from which to derive a trigger pulse, as in "trigger source", "trigger input", etc.

Trigger Countdown—A process that reduces the repetition rate of a triggering signal.

Triggering Level—The instantaneous level of a triggering signal at which a trigger is to be generated. Also the name of the control which selects the level.

Triggering Signal—The signal from which a trigger is derived.

Triggering Slope—The positive-going (+ slope) or negative-going (— slope) portion of a triggering signal from which a Trigger is to be derived. Also, the control which selects the slope to be employed.

Note: + slope and — slope apply to the slope of the waveform only, and not to the absolute polarity.

Unblinking—Turning on of the CRT beam.

Undershoot—In the display of a step function (usually of time), that portion of the waveform which, following any overshoot or rounding which may be present, falls below its nominal or final value.

Write Through Mode—That mode of operating a storage tube where the stored information is retained, and the writing beam is operated to produce a non-storing display, as in the conventional mode.

Writing Gun—A high-energy electron gun giving a narrow focused beam which can be deflected and is used to write the information to be stored.

Writing Speed—See Information Writing Speed.

Writing Speed Enhancement—A method of altering electrode potentials to increase the stored writing speed.

Writing Time/Div—The minimum time per unit distance required to record a trace. The method of recording must be specified.

X-Y Display—A rectilinear coordinate plot of two variables.

Z-Axis Amplifier—An amplifier for signals controlling a display perpendicular to the X-Y Axis (commonly intensity of the spot).

DC-to-4 MHz PORTABLE OSCILLOSCOPE



- **SMALL SIZE—LIGHT WEIGHT**
- **4-MHz BANDWIDTH**
- **10 mV/div DEFLECTION FACTOR**
- **AMPLITUDE CALIBRATOR**

The Type 310A Oscilloscope is an instrument you can take with you—easily, comfortably. Small size and low weight combined with operation on 50- to 800-hertz line frequency make this an ideal instrument for maintenance and calibration of specialized measuring and recording instruments at their point of use. Accurate calibration and excellent linearity assure precise time and amplitude measurements either in the laboratory or in the field. Panel design and controls contribute to operator convenience.

CHARACTERISTIC SUMMARY

VERTICAL

BANDWIDTH—0.1 V/div to 50 V/div, DC to 4 MHz. 10 mV/div to 50 mV/div, 2 Hz to 3.5 MHz.

RISE TIME—90 ns to 0.1 V/div, 100 ns to 10 mV/div.

CALIBRATED DEFLECTION FACTOR

DC-coupled, 0.1 V/div to 50 V/div.

AC-coupled only, 10 mV/div to 50 mV/div.

INPUT RC—1 megohm paralleled by approx 40 pF.

HORIZONTAL

CALIBRATED TIME BASE—0.5 μ s/div to 0.2 s/div.

X5 MAGNIFIER—Extends time base to 0.1 μ s/div.

EXTERNAL INPUT—1.5 V/div, DC to 500 kHz.

CRT

DISPLAY AREA—8 x 10 div. Each div equal to 1/4 inch.

ACCELERATING VOLTAGE—1.85 kV.

PHOSPHOR—P31.

OTHER

AMPLITUDE CALIBRATOR—50 mV to 100 V, approx 1-kHz squarewave.

POWER REQUIREMENTS—105 to 125 V or 210 to 250 V, 175 watts.

TYPE 310A

VERTICAL DEFLECTION

BANDWIDTH

DC to 4 MHz at 3-dB down to 0.1 V/div, 2 Hz to 3.5 MHz at 3 dB down to 10 mV/div. Low-frequency 3 dB down point, AC coupled: 2 Hz, 0.2 Hz with included 10X probe.

RISETIME

≈90 ns to 0.1 V/div; ≈100 ns to 10 mV/div.

DEFLECTION FACTOR

10 mV/div to 50 V/div in 12 calibrated steps (1-2-5 sequence), accurate within 3%. AC coupled at 10 mV/div to 50 mV/div. Uncalibrated, continuously variable between steps and to approx 125 V/div. Warning light indicates uncalibrated setting.

INPUT RC

1 megohm paralleled by approx 40 pF.

HORIZONTAL DEFLECTION

TIME BASE

0.5 μs/div to 0.2 s/div in 18 calibrated steps (1-2-5 sequence), accurate within 3%. Uncalibrated, continuously variable between steps and to approx 0.6 s/div. Warning light indicates uncalibrated setting.

X5 MAGNIFIER

Operates over full time base, increases fastest rate to 0.1 μs/div. Magnified time base accurate within 4% (5% at 0.1 μs/div).

EXTERNAL INPUT

1.5 V/div, adjustable. DC to 500 kHz at -3 dB. Input R approx 100 kΩ.

TRIGGERING

MODES

Manual or automatic. Automatic operation is useful between approx 60 Hz and 2 MHz, minimizes trigger adjustment for signals of different amplitudes, shapes and repetition rates. With no input, automatic triggering occurs at an approx 50 Hz rate, providing a convenient reference trace.

COUPLING

AC or DC.

SOURCES

Internal, external, or line.

REQUIREMENTS

0.25-div deflection or 0.2 V external from DC to 1 kHz, increasing to 2-div deflection or 2 V external at 5 MHz. AC coupling response -3 dB at 16 Hz. Automatic operation requires 0.25 div deflection or 0.2 V external from 60 Hz to 1 kHz, increasing to 2-div deflection or 2.0 V external at 2 MHz.

CRT

TEKTRONIX CRT

8 x 10-div display area; each div is 1/4 inch. 3-inch tube operates at 1.85-kV accelerating voltage. P31 phosphor normally supplied. Z-axis input is AC coupled to CRT cathode, requires 20 V peak to peak for beam modulation at normal intensity.

GRATICULE

External; variable edge lighting. Vertical and horizontal centerlines marked in 5 minor divisions per major 1/4-inch division.

OTHER CHARACTERISTICS

AMPLITUDE CALIBRATOR

50 mV to 100-V squarewave, 11 calibrated steps (1-2-5 sequence), accurate within 3%. Approx 1-kHz repetition rate.

POWER REQUIREMENTS

Wired for 105 to 125 VAC (117-V nominal). Transformer taps permit operation at nominal voltages of 110, 117, 124, 220, 234 and 248 VAC, 50 to 800 Hz (requires approx 4% higher line voltage at 800 Hz). Power consumption approx 175 W. Can be factory wired for any of the above nominal voltages, if so indicated on order.

DIMENSIONS AND WEIGHTS

Height	10 ⁷ / ₈ in	27.6 cm
Width	6 ¹⁵ / ₁₆ in	17.6 cm
Depth	17 ¹ / ₁₆ in	44.9 cm
Net Weight	23 ¹ / ₂ lb	10.7 kg
Domestic shipping weight	≈30 lb	≈13.6 kg
Export-packed weight	≈38 lb	≈17.3 kg

INCLUDED STANDARD ACCESSORIES

P6012 probe (010-0203-00); 18-in BNC-to-BNC patch cord (012-0087-00); 18-in BNC-to-banana plug patch cord (012-0091-00); BNC post jack (012-0092-00); 3-conductor power cord (161-0024-01); 3 to 2-wire adapter (103-0013-00); smoke gray filter (378-0550-00); two instruction manuals (070-0244-00).

OPTIONAL ACCESSORIES

Optional accessories increase measurement capability and provide added convenience. The standard probe supplied with the instrument satisfies most measurement requirements; optional probes may be better suited for particular applications. See catalog accessory pages for additional information on these and other items.

CARRYING CASE

Protects Type 310A, provides convenient accessory storage compartment, order 016-0028-01

C-30 CAMERA

f/1.9 lens; magnification variable from 1.5:1 to 0.7:1; Polaroid Land* Pack-film back

Type 310A to C-30 Camera adapter, order 016-0241-00

C-30 CAMERA CARRYING CASE

Holds the C-30 Camera, all standard accessories and extra film, order 016-0092-00

PROBES

P6007 100X Probe Package, order 010-0150-00

P6011 1X Miniature Probe Package, order 010-0193-00

FAN BASE



Provides filtered forced-air ventilation recommended for continuous operation at 25°C or higher. Tilts Type 310A for convenient viewing.

Order 016-0012-00 for 105 to 125 V, 50 to 60 Hz

Order 016-0013-00 for 210 to 250 V, 50 to 60 Hz

*Registered Trade-Mark Polaroid Corporation

Please refer to Terms and Shipment, General Information page.

DC-to-10 MHz
9-kV OSCILLOSCOPES

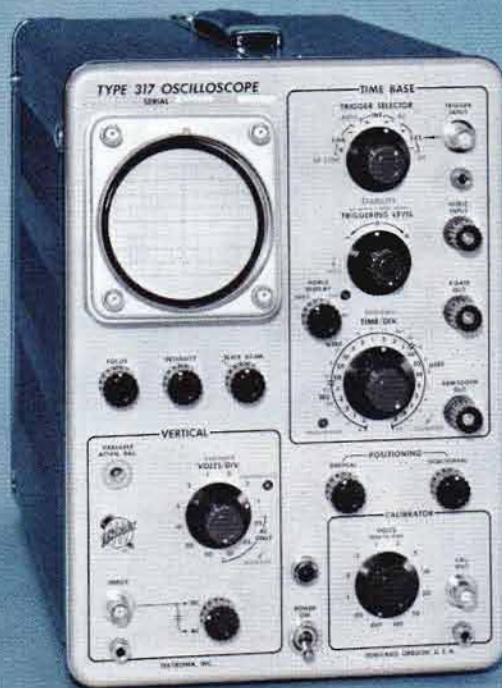

- **BRIGHT TRACE**
- **10-MHz BANDWIDTH AT 10 mV/div**
- **INTERNAL DELAY LINE**
- **COMPACT CABINET OR RACK MODELS**
- **AMPLITUDE CALIBRATOR**

The Type 317 is an excellent oscilloscope for the daylight conditions often encountered in the field and at production test stations. Its brilliant trace, provided by 9-kV accelerating potential on a Tektronix 3-inch cathode-ray tube, is easily readable in bright areas . . . even at low sweep-repetition rates. Its DC-to-10 MHz vertical response and wide sweep range provide the measurement capability necessary for many of today's complex field and test station applications. Of course, these fine characteristics make it an excellent laboratory oscilloscope, too.

CHARACTERISTIC SUMMARY

VERTICAL

BANDWIDTH—DC-coupled, DC to 10 MHz. AC-coupled, 2 Hz to 10 MHz.
RISETIME—35 ns.
CALIBRATED DEFLECTION FACTOR—
 DC-coupled, 0.1 V/div to 50 V/div.
 AC-coupled, 10 mV/div to 50 V/div.
INPUT RC—1 megohm paralleled by approx 40 pF.

HORIZONTAL

CALIBRATED TIME BASE—0.2 μ s/div to 2 s/div.
X5 MAGNIFIER—Extends calibrated time base to 40 ns/div.
EXTERNAL INPUT—1.4 V/div, DC to 500 kHz.

CRT

DISPLAY AREA—8 x 10 div. Each div equal to 1/4 inch.
ACCELERATING VOLTAGE—9 kV.
PHOSPHOR—P31.

OTHER

AMPLITUDE CALIBRATOR—50 mV to 100 V, approx 1-kHz squarewave.
POWER REQUIREMENTS—105 to 125 V or 210 to 250 V, 300 watts maximum.

TYPE **317** **RM17**

VERTICAL DEFLECTION

BANDWIDTH

DC to 10 MHz at 3-dB down to 0.1 V/div, 2 Hz to 10 MHz at 3-dB down to 10 mV/div. Low-frequency 3-dB point, AC coupled: 2 Hz, 0.2 Hz with included 10X probe.

RISETIME

≈35 ns.

DEFLECTION FACTOR

10 mV/div to 50 V/div in 12 calibrated steps (1-2-5 sequence), accurate within 3%. AC coupled at 10 mV/div to 50 mV/div. Uncalibrated, continuously variable between steps and to approx 125 V/div. Warning light indicates uncalibrated setting.

INPUT RC

1 megohm paralleled by approx 40 pF.

DELAY LINE

Permits viewing leading edge of displayed waveform.

HORIZONTAL DEFLECTION

TIME BASE

0.2 μs/div to 2 s/div in 22 calibrated steps (1-2-5 sequence), accurate within 3%. Uncalibrated, continuously variable between steps and to at least 5 s/div. Warning light indicates uncalibrated setting.

X5 MAGNIFIER

Operates over full time base, increases fastest rate to 40 ns/div. Magnified time base accurate within 5%.

EXTERNAL INPUT

1.4 V/div, adjustable. DC to 500 kHz at -3 dB. Input R approx 100 kΩ.

FRONT-PANEL OUTPUTS

≈20-V positive gate, ≈150-V positive-going sawtooth.

TRIGGERING

MODES

Manual or automatic triggering, high-frequency sync. Automatic operation is useful between approx 60 Hz and 2 MHz, minimizes trigger adjustment for signals of different amplitudes, shapes, and repetition rates. With no input, automatic triggering occurs at an approx 50-Hz rate, providing a convenient reference trace. High-frequency sync assures a steady display of sinewaves to 15 MHz.

COUPLING

AC to DC.

SOURCES

Internal, external, or line.

REQUIREMENTS

0.2-div deflection or 0.5 V external from DC to 1 kHz, increasing to 2-div deflection or 4 V external at 5 MHz. AC coupling response -3 dB at approx 16 Hz. Automatic operation requires 0.5-div deflection or 1 V external from 60 Hz to 1 kHz, increasing to 2-div deflection or 4 V external at 2 MHz. High-frequency sync requires 0.2-div deflection or 0.5 V external at 5 MHz, increasing to 2-div deflection or 4 V external at 15 MHz.



CRT

TEKTRONIX CRT

8 x 10-div display area; each div is 1/4 inch. 3-inch tube provides brilliant trace with 9-kV accelerating potential. P31 phosphor is normally supplied. Z-axis input is AC coupled to CRT cathode, requires 10 V peak to peak for beam modulation at normal intensity.

GRATICULE

External; variable edge lighting. Vertical and horizontal centerlines marked in 5 minor divisions per major 1/4-inch division.

OTHER CHARACTERISTICS

AMPLITUDE CALIBRATOR

50 mV to 100-V squarewave, 11 calibrated steps (1-2-5 sequence), accurate within 3%. Approx 1-kHz repetition rate.

POWER REQUIREMENTS

Wired for 105 to 125 VAC (117-V nominal). Transformer taps permit operation at nominal voltages of 110, 117, 124, 220, 234 and 248 VAC, 50 to 60 Hz. Power consumption 300 W maximum. Can be factory wired for any of the above nominal voltages, if so indicated on order.

CABINET MODEL DIMENSIONS AND WEIGHTS

Height	12 ³ / ₈ in	31.4 cm
Width	8 ¹ / ₂ in	21.6 cm
Depth	18 ¹ / ₁₆ in	47.5 cm
Net weight	33 lb	15.0 kg
Domestic shipping weight	≈46 lb	≈21.0 kg
Export-packed weight	≈57 lb	≈25.9 kg

RACK MODEL DIMENSIONS AND WEIGHTS

Height	7 in	17.8 cm
Width	19 in	48.3 cm
Rack depth	18 ¹ / ₈ in	46.0 cm
Net weight	36 ¹ / ₂ lb	16.6 kg
Domestic shipping weight	≈65 lb	≈29.5 kg
Export-packed weight	≈89 lb	≈40.5 kg

RACK-MOUNTING

Type RM17 withdraws from rack on slide-out tracks, tilts and locks in 7 positions. Further mounting information on catalog instrument dimension page.

INCLUDED STANDARD ACCESSORIES

P6012 probe (010-0203-00); 18-in BNC-to-BNC patch cord (012-0087-00); 18-in BNC-to-banana-plug patch cord (012-0091-00); BNC post jack (012-0092-00); 3-conductor power cord (161-0010-03); 3 to 2-wire adapter (103-0013-00); smoke gray filter (378-0550-00); two instruction manuals (070-0297-00). Type RM17 includes same accessories except two manuals (070-0325-00); also includes mounting tracks (351-0083-00) and hardware.

OPTIONAL ACCESSORIES

Optional accessories increase measurement capability and provide added convenience. The standard 10X probe supplied with the instrument satisfies most measurement requirements; optional probes may be better suited for particular applications. See catalog accessory pages for additional information on these and other items.

PROBES

P6007 100X Probe Package, order 010-0150-00

P6011 1X Miniature-Probe Package, order 010-0193-00

SUPPORTING CRADLE

Required to mount Type RM17 in backless rack, order 040-0345-00

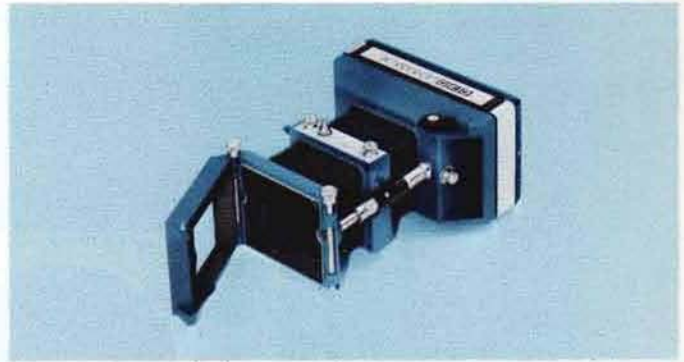

C-30 CAMERA

f/1.9 lens; magnification variable from 1.5:1 to 0.7:1;
Polaroid Land* Pack-film

Type 317 to C-30 Camera adapter, order 016-0241-00



C-30 CAMERA CARRYING CASE

Holds the C-30 Camera, all standard accessories and extra film, order 016-0092-00

*Registered Trade-Mark Polaroid Corporation

Please refer to Terms and Shipment, General Information page.

TYPE 321A

DC-to-6 MHz PORTABLE OSCILLOSCOPE



- 6 MHz BANDWIDTH AT 10 mV/DIV
- SMALL SIZE—LIGHT WEIGHT
- SOLID-STATE DESIGN
- LOW POWER CONSUMPTION
- AC, DC, OR BATTERY OPERATED
- DESIGNED FOR SEVERE ENVIRONMENTS

The Type 321A is a high-performance DC-to-6 MHz Oscilloscope. Its rugged mechanical and electrical design plus a choice of power options make it ideal for field operations requiring accurate waveform measurements. With internal batteries, it weighs 17 pounds; without batteries, it weighs 14 pounds.

CHARACTERISTIC SUMMARY

VERTICAL

BANDWIDTH—DC to 6 MHz.

RISETIME—58 ns

CALIBRATED DEFLECTION FACTOR—10 mV/div to 20 V/div, DC coupled.

INPUT RC—1 megohm paralleled by approx 35 pF.

HORIZONTAL

CALIBRATED TIME BASE—0.5 μ s/div to 0.5 s/div.

X5 MAGNIFIER—Extends time base to 0.1 μ s/div.

EXTERNAL INPUT—1 V/div, DC to 1 MHz.

CRT

DISPLAY AREA—6 x 10 div. Each div equal to 1/4 inch.

ACCELERATING VOLTAGE—4 kV.

PHOSPHOR—P31

OTHER

AMPLITUDE CALIBRATOR—500-mV squarewave peak to peak and internal 40-mV squarewave peak to peak at approx 2 kHz.

POWER OPTIONS—10 size D batteries; external DC supply of 11.5 to 35 V, \leq 700 mA; 115 VAC \pm 10% or 230 VAC \pm 10%, 45 to 800 Hz, 20 W.

VERTICAL DEFLECTION

BANDWIDTH

DC to 6 MHz at 3-dB down. Low-frequency 3-dB-down point with AC coupling is ≤ 2 Hz, extended to ≤ 0.2 Hz when using the included 10X probe.

RISETIME

≤ 58 ns.

DEFLECTION FACTOR

10 mV/div to 20 V/div in 11 calibrated steps (1-2-5 sequence), accurate within 3%. Uncalibrated, continuously variable between steps and to approx 50 V/div.

INPUT RC

1 megohm paralleled by approx 35 pF.

MAXIMUM INPUT VOLTAGE

600 V combined DC + peak AC.

HORIZONTAL DEFLECTION

TIME BASE

0.5 μ s/div to 0.5 s/div in 19 calibrated steps (1-2-5 sequence), accurate within 3%. Uncalibrated, continuously variable between steps and to approx 1.5 s/div.

X5 MAGNIFIER

Extends all time base steps, the fastest to 0.1 μ s/div. Magnified display accurate within 3%.

EXTERNAL INPUT

1 V/div $\pm 10\%$ with X5 magnifier. DC to ≥ 1 MHz at -3 dB. Input RC approx 100 k Ω paralleled by approx 30 pF.

TRIGGER

MODES

Automatic or manual level selection, or free run. Automatic operation is useful above 50 Hz, minimizes trigger adjustment for signals of different amplitudes, shapes, and repetition rates. With no input, automatic triggering occurs at an approx 50-Hz rate, providing a convenient reference trace.

COUPLING

AC or DC

SOURCES

Internal or external. External trigger input RC approx 100 k Ω paralleled by approx 5 pF.

REQUIREMENTS

0.2-div deflection or 1 V external from DC to 1 kHz, increasing to 1-div deflection or 3 V external at 6 MHz. Requirements increase below 600 Hz for internal AC-coupled triggering, and below approx 16 Hz with external AC-coupled triggering.

CRT

TEKTRONIX CRT

6 x 10-div display area; each div is $\frac{1}{4}$ inch. 3-inch tube provides bright trace, utilizes low heater power. 4-kV accelerating potential. P31 phosphor normally supplied. Z-axis input is AC coupled to CRT control grid, requires 15 V peak to peak for beam modulation at normal intensity.

GRATICULE

External; variable edge lighting when instrument is operated from AC line. Vertical and horizontal centerlines marked in 5 minor divisions per major $\frac{1}{4}$ -inch division.

ENVIRONMENTAL CAPABILITIES

TEMPERATURE

Operating (without batteries) -15°C to $+55^{\circ}\text{C}$.
(with batteries installed) 0°C to $+40^{\circ}\text{C}$.
Non-operating (without batteries) -55°C to $+75^{\circ}\text{C}$.
(with batteries installed) -40°C to $+60^{\circ}\text{C}$.

ALTITUDE

Operating: 15,000 ft max.
Non-operating: 50,000 ft max.

VIBRATION

Operating: 15 minutes along each of 3 axes at 0.025 in peak to peak displacement (4 g's at 55 c/s), 10 to 55 to 10 c/s in 1-minute cycles.

SHOCK

Operating: 20 g's, $\frac{1}{2}$ sine, 11-ms duration, 12 shocks total.
Non-operating: 60 g's, $\frac{1}{2}$ sine, 11-ms duration, 6 shocks total.

HUMIDITY

Non-operating: Meets electrical performance specifications after exposure to five cycles (120 hours) of Mil-Std-202C, Method 106B (omit freezing and vibration, and allow a post-test drying period at $+20^{\circ}\text{C}$ and 25% to 80% relative humidity).

TRANSPORTATION

In shipping carton: meets National Safe Transit test-vibration for one hour at slightly greater than 1 g; 18 in drop on any corner, edge, or flat surface of the shipping container.

OTHER CHARACTERISTICS

AMPLITUDE CALIBRATOR

500 mV at external jack; accurate within 2% at 25°C , within 3% throughout operating range. 40 mV applied internally to vertical amplifier; accurate within 3% at 25°C , within 4% throughout operating range. ≤ 2 - μ s risetime; 2 kHz $\pm 20\%$ repetition rate; 45% to 55% duty cycle.

POWER OPTIONS

Wired for 115 V RMS $\pm 10\%$, 45 to 800 Hz; tapped transformer also allows operation at 230 V $\pm 10\%$; 20-W maximum power consumption for oscilloscope only, 30-W maximum with internal batteries under full charge. Operates on external DC supply from 11.5 to 35 V DC; draws ≤ 700 mA. Operates on 10 internal size D batteries. Flashlight cells provide approx $\frac{1}{2}$ hour continuous operation (longer on intermittent operation). Alkaline cells such as Eveready E95, Burgess AL-2 or Mallory MN-1300 provide approx 2 $\frac{1}{2}$ hours continuous operation; NiCd rechargeable cells provide approx 5 $\frac{1}{2}$ hours continuous operation. Front-panel light indicates when internal batteries are low or, (using external power) when the voltage source drops too low for proper power supply regulation.

BATTERY CHARGER

Internal charger provides two different charging currents to the internal batteries (except dry cells). A trickle charge or a full charge is applied to the internal batteries when the instrument is turned off, but connected to the AC line.

TYPE 321A

DIMENSIONS AND WEIGHTS

Height	8 $\frac{3}{4}$ in	22.2 cm
Width	5 $\frac{3}{4}$ in	14.6 cm
Depth	16 $\frac{1}{2}$ in	41.9 cm
Net weight	14 $\frac{1}{4}$ lb	6.5 kg
Domestic shipping weight	≈22 lb	≈10.0 kg
Export packed weight	≈33 lb	≈15.0 kg

INCLUDED STANDARD ACCESSORIES

P6012 10X probe (010-0203-00); two 18 in BNC-to-banana plug patch cords (012-0091-00); DC power cord (161-0016-01); AC power cord (161-0015-01); 3 to 2-wire adapter (103-0013-00); smoke-gray light filter (378-0547-00); mesh filter, installed (378-0577-00); two instruction manuals (070-0425-00).

OPTIONAL ACCESSORIES

Optional accessories increase measurement capability and provide added convenience. The standard 10X probe supplied with the instrument satisfies most measurement requirements; optional probes may be better suited for particular applications. In addition to the listed optional probes, other probes are available for current and high-voltage measurements. See catalog accessory pages for additional information on these and other items.

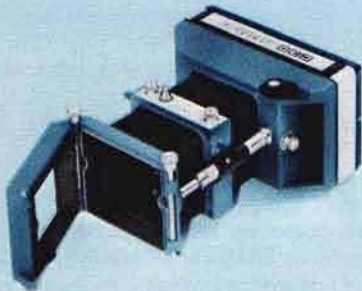

C-30 CAMERA

f/1.9 lens; magnification variable from 1.5:1 to 0.7:1; Polaroid Land* Pack-Film back

321A to C-30 Camera adapter, order 016-0242-00

*Registered Trade-Mark Polaroid Corporation



C-30 CAMERA CARRYING CASE

Holds the C-30 Camera, all standard accessories and extra film, order 016-0092-00



TYPE 321A CARRYING CASE

Protects Type 321A, provides convenient accessory storage compartment, order 016-0026-00

RECHARGEABLE BATTERIES

Each NiCd cell, order 146-0010-00

Set of 10 NiCd cells, order 016-0077-01

PROBES

P6007 100X Probe Package, order 010-0150-00

P6011 1X Miniature-Probe Package, order 010-0193-00

Please refer to Terms and Shipment, General Information page.

TYPE 410

PHYSIOLOGICAL MONITOR



NEW

- **DISPLAYS ECG, EEG, OR PULSE WAVEFORMS**
- **SIMPLE CONTROLS**
- **SOLID-STATE RELIABILITY, QUICK TURN ON**
- **PORTABLE, BATTERY POWERED**
- **HEART RATE BEEP**
- **RAPID OVERLOAD RECOVERY**

The Type 410 is designed for patient monitoring during surgery, recovery, and intensive care. Of special use to the anesthesiologist, it displays on a cathode-ray tube waveforms of the electrocardiogram (ECG), electroencephalogram (EEG), or pulse. During surgery, the Type 410 can give early warning of a developing problem. Other applications of the Type 410 include measurements of fetal ECGs, using the high-gain input (EEG) and electrodes supplied with the Monitor.

The Monitor can be conveniently positioned (using the optional mounting fixture) at the five-foot level on the anesthesiologist's gas machine for easy viewing, then lifted off and carried with the patient to the recovery room. The 12½-pound weight and battery operation permit easy mobility and continuous operation without disconnecting leads or power.

Ease of operation, with a minimum of controls, contributes to the usability of the Type 410, as do its other features: 4-second recovery after overdrive by defibrillator or cauterizer, output for strip-chart recorder, and a cabinet finish that is durable and washable.

TYPE 410



ECG MEASUREMENTS

Heart rates from 35 beats/min to 180 beats/min can be directly read by observing the point on the CRT graticule scale where the second R wave occurs. A beep sound coincident with each repetition of the ECG waveform provides an audible indication of heart rate, in addition to the waveform display. Thus a sudden change in heart rate can be quickly detected, even without constant observation of the display. Loss of signal to the Monitor for 2 to 4 seconds automatically increases the rate of the beep to an alarm level, and also provides a baseline on the CRT. Bandwidth in the ECG mode is ≤ 0.1 Hz to 250 Hz $\pm 15\%$. Deflection sensitivity is 20 mm/mV, accurate within 5%. Seven commonly-used leads can be selected: I, II, III, aV_R, aV_L, aV_F and V. Silver-silver chloride non-polarizing electrodes are supplied as standard accessories. The Type 410 is also compatible with common needle electrodes and inexpensive disposable surface electrodes.

EEG MEASUREMENTS

EEG input accepts the included silver-silver chloride EEG electrodes supplied with the Monitor. Optional EEG electrodes (identical except for color coding) are also available. Bandwidth in the EEG mode is ≤ 0.1 Hz to 100 Hz $\pm 15\%$. Deflection sensitivity is 10 mm/50 μ V, accurate within 5%.

PULSE MEASUREMENTS

Auxiliary input accepts the optional photosensitive pulse sensor. The pulse sensor, containing a light source and photo-resistor, is attached to the patient's finger. As the pulse occurs, the amount of blood in the finger changes the amount of light reaching the photo-resistor. The resulting display provides a quick indication of heart rate. A beep sounds coincident with each pulse, giving an audible as well as visible indication of the patient's heart activity. Loss of signal to the Monitor for 2 to 4 seconds automatically increases the rate of the beep to an alarm level, and provides a base line on the CRT. Bandwidth at the Auxiliary mode input is ≤ 0.1 Hz to 250 Hz $\pm 15\%$. Deflection sensitivity is 2 mm/mV, accurate within 5%.

HIGH COMMON-MODE REJECTION

$\geq 500,000:1$ throughout bandwidth with a balanced, low-impedance source. 50,000:1 AUX; 100,000:1 ECG; 150,000:1 EEG at 60 Hz with 5-k Ω source impedance unbalance between properly-applied electrodes. High common-mode rejection, with corresponding reduction of interference is obtained under actual operating conditions.

COMMON-MODE DYNAMIC RANGE

+3 V to -3 V.

DIFFERENTIAL DYNAMIC RANGE

Monitor characteristics are valid with an input terminal DC potential difference (offset) of up to 20 mV. Typically less than 10 mV difference exists between the non-polarizable silver-silver chloride electrodes supplied with the Type 410. At least 100 mV of either polarity can be applied with no more than 5% reduction in amplifier gain.

DIFFERENTIAL INPUT RESISTANCE

2 M Ω $\pm 15\%$ in EEG and ECG mode, 20 M Ω $\pm 15\%$ in Auxiliary mode.

DRIFT

≤ 0.5 cm per hour after 10-second warm-up.

NOISE

≤ 0.1 cm in the calibrated EEG mode, input shorted.

SWEEP SPEEDS

25, 50, and 100 mm per second; accurate within 5%.

AUDIO SIGNAL

Beep sounds at heart rate, providing audible indication of normal or arrhythmic heart rate. Automatic alarm sounds if there is a loss of signal for 2 to 4 seconds. Loudness is adjustable. Using the audio output jack disconnects the internal speaker.

WAVEFORM SIZE

Vertical size of ECG, EEG, and pulse waveforms is continuously variable from $\frac{1}{3}$ to 3 times the height of the calibrated display.

Pulse display—approx 75 beats/minute

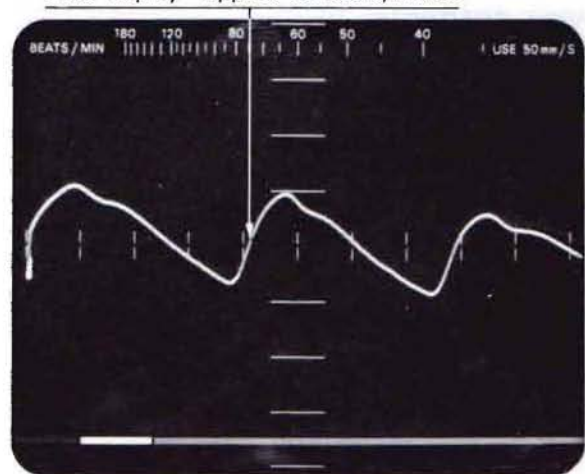

CRT

5-inch rectangular CRT has 8 x 10-cm viewing area. P-7 phosphor has long decay time for convenient viewing at slow sweep speeds. The external graticule has a graduated heart-rate scale at the top, a battery-condition scale at the bottom, and a vertical and horizontal center-line scale marked in centimeters.

BATTERY OPERATION

Removable battery pack contains 10 size "C" NiCd cells, provides 8 to 12 hours operation with maximum accessory load at +20°C to +25°C. Operating time depends on temperature. Maximum time is achieved at 22°C. Internal charger provides recharge in 21 to 24 hours, operates from 90 V to 136 VAC or 180 V to 272 VAC, 48 Hz to 440 Hz, requires ≤ 7 W at 115 V, 60 Hz. Monitor can also be operated from line (with reduced charge to battery pack).

CLEANING

Monitor and accessories can be damp wiped with mild soap and water.



DIMENSIONS AND WEIGHTS

Height	5 ³ / ₈ in	13.7 cm
Width without handle	8 ¹ / ₂ in	21.6 cm
Width with handle	9 ¹ / ₈ in	23.2 cm
Depth without handle	10 ³ / ₄ in	27.4 cm
Depth with handle	12 ⁷ / ₈ in	32.7 cm
Weight without accessories	12 ¹ / ₂ lb	5.6 kg
Domesic shipping weight	≈20 lb	≈11.4 kg
Export packed weight	≈30 lb	≈13.6 kg

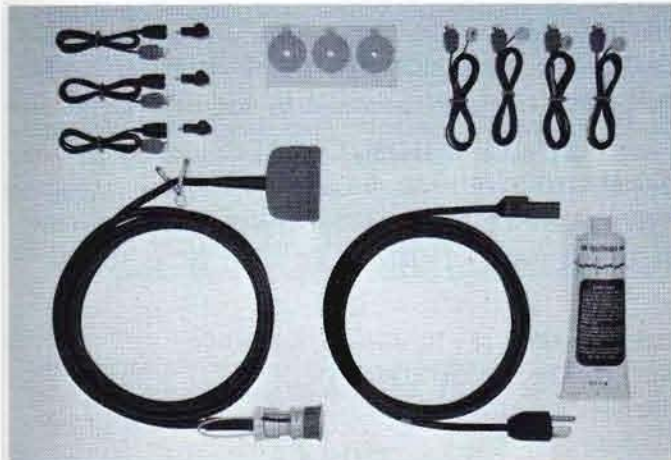

INCLUDED STANDARD ACCESSORIES

Power cable assembly (161-0037-00); patient cable assembly (012-0120-00); electrode LA black (012-0121-00); electrode

LL red (012-0121-02); electrode RL green (012-0121-05); electrode RA white (012-0121-09); package adhesive electrode rings (006-1099-00); tube electrode paste (006-1098-00), three 3-cable electrode adapter kits (012-0122-00), two instruction manuals (070-0658-00).

OPTIONAL ACCESSORIES

MOUNTING STAND

Mounts Type 410 at the five-foot level, permits swivelling and tipping the Monitor for convenient viewing. Hardware supplied with the fixture attaches to gas machine, bed, flat or round surface up to 1¹/₂ inch diameter. Order 016-0110-00

MOUNTING CUP

Mounts Type 410 to flat surface, permits tipping the Monitor for convenient viewing. Mounting screws not included; Order 407-0393-01

CHEST ELECTRODE

Brown color code. Order 012-0121-01

EEG ELECTRODE

Yellow color code, 2 required Order 012-0121-04 (each)

PULSE SENSOR ASSEMBLY

Photoresistive sensor for pulse measurements, used with Type 410 Auxiliary input. Order 015-0104-00



BATTERY PACK

Extra battery pack, in addition to the one supplied with the Type 410, allows one pack to charge while the other is powering the Monitor. Pack contains 10 size "C" NiCd cells and battery charger. Order 016-0107-00

Please refer to Terms and Shipment, General Information page.

TYPE **422** **R422**

DC-to-15 MHz PORTABLE OSCILLOSCOPES



- **SMALL SIZE—LIGHT WEIGHT**
- **DUAL TRACE**
- **SHARP, BRIGHT DISPLAYS**
- **DESIGNED FOR SEVERE ENVIRONMENTS**
- **AC AND AC/DC VERSIONS**
- **ILLUMINATED PARALLAX-FREE GRATICULE**

The Type 422 is a portable dual-trace oscilloscope that combines small size and light weight with the ability to make precise waveform measurements. It weighs under 22 pounds and occupies less than 0.6 cubic foot. To make it truly portable, the Type 422 is ruggedly constructed to withstand shock, vibration, and other extremes of environment. No longer need measurements be compromised due to adverse field conditions; the Type 422 brings the precision of the laboratory to the field.

Two models are available. One operates on AC; the other on AC or DC, with an optional battery pack for completely portable operation. The AC model is also available as Type R422, arranged in a rackmount panel assembly with a hinged-door compartment for storing accessories. The hinged door can be removed to allow the installation of a second Type 422 for applications that require two instruments. The entire assembly is mounted to the rack with slide-out tracks.

CHARACTERISTIC SUMMARY

VERTICAL

(2 Identical Channels)

BANDWIDTH—DC to 15 MHz.

RISETIME—23 ns.

CALIBRATED DEFLECTION FACTOR—10 mV/div to 20 V/div.

INPUT RC—1 megohm paralleled by approx 30 pF.

HORIZONTAL

CALIBRATED TIME BASE—0.5 μ s/div to 0.5 s/div.

X10 MAGNIFIER—Extends fastest time-base to 0.05 μ s/div.

EXTERNAL INPUT—1 V/div to 100 V/div, DC to 500 kHz.

CRT

DISPLAY AREA—8 x 10 divisions (0.8 cm/div).

ACCELERATING VOLTAGE—6 kV.

PHOSPHOR—P31

OTHER

AMPLITUDE CALIBRATOR—0.2 V peak to peak, internally; 2 V peak to peak, front-panel jack; 1-kHz squarewave (approx).

POWER OPTIONS—

AC Model: 115 V or 230 V \pm 10%, 45 to 440 Hz, approx 40 W.

AC/DC Model: AC mode—115 V or 230 V \pm 20%, 45 to 440 Hz except derate line voltage limits to +10% and -20% from 50 Hz to 45 Hz, approx 27 W. DC mode—11.5 V to 35 V, approx 23 W. Also accepts 24 V battery pack.

VERTICAL DEFLECTION

(2 Identical Channels)

BANDWIDTH

DC to 15 MHz at 3-dB down (each channel); 5 Hz to 5 MHz at 3-dB down, on X10 gain (channel 2). Low-frequency 3-dB-down point is ≈ 2 Hz with AC coupling (each channel), ≈ 0.2 Hz with included 10X probe.

RISETIME

23 ns each channel; 70 ns at X10 gain (channel 2).

DEFLECTION FACTOR

10 mV/div to 20 V/div in 11 calibrated steps, 1-2-5 sequence (each channel). Deflection factor extended to 1 mV/div in X10 position (channel 2). All steps accurate within 3%; 7.5% on X10 GAIN (channel 2). Uncalibrated, continuously variable between steps and to approx 50 V/div. Warning light indicates uncalibrated setting.

INPUT RC

1 megohm paralleled by approx 30 pF. Channel 1 and 2 time constants matched to $\pm 1\%$.

MAXIMUM INPUT VOLTAGE

300 V combined DC and peak AC.

OPERATING MODES

Channel 1 only; Channel 2 only; Channels 1 and 2 added algebraically; dual-trace chopped; dual-trace alternate. In chopped operation, successive 5- μ s segments of each channel are displayed at an approx 100-kHz rate. Channel 2 has polarity inversion. Common-mode rejection ratio is $\geq 100:1$ at 50 kHz with Channels 1 and 2 adjusted for equal gain.

DELAY LINE

Permits viewing of leading edge of triggering waveform.

HORIZONTAL DEFLECTION

TIME BASE

0.5 μ s/div to 0.5 s/div in 19 calibrated steps (1-2-5 sequence), accurate within 3%. Uncalibrated, continuously variable between steps and to approx 1.25 s/div. Warning light indicates uncalibrated vernier settings.

X10 MAGNIFIER

Operates over full time base, increases fastest rate to 50 ns/div. Accuracy of magnified time base is within 5%.

EXTERNAL INPUT

Variable between approx 10 V/div to 100 V/div and approx 1 V/div to 10 V/div with X10 magnifier. DC to ≥ 500 kHz at 3-dB down. Input RC approx 300 k Ω paralleled by approx 35 pF.

OTHER

Gate output (on front panel) is a negative-going rectangular pulse with same duration as time base; 0.5 V minimum; approx 600-ohm source impedance.

TRIGGER

MODES

Manual level selection; Automatic; Free Run. Automatic triggering may be used for signal repetition rates above 50 Hz, eliminating the need for re-adjusting trigger LEVEL while sequentially viewing signals of different amplitudes, shapes, and repetition rates. With no input, automatic triggering occurs at an approx 50-Hz rate, providing a convenient reference trace.

COUPLING

DC; AC; AC LOW FREQ REJECT.

SOURCES

Internal: Channels 1 and 2, Channel 1 only;
External: Input RC is approx 300 k Ω paralleled by approx 35 pF. Positive or Negative slope.

REQUIREMENTS

DC: 0.2-div deflection or 125 mV ext up to 5 MHz, increasing to 1 div or 0.6 V at 15 MHz.

AC: Same as DC except low-frequency response is 3-dB down at approx 25 Hz.

AC LOW FREQ REJECT: Same as DC except low-frequency response is 3-dB down at approx 25 kHz.

AUTOMATIC: Int: 0.8 div from 50 Hz to 4 MHz, increasing to 2.5 div at 15 MHz.

EXT: 0.6 V from 50 Hz to 7 MHz, increasing to 1.2 V at 15 MHz.

OTHER CHARACTERISTICS

AMPLITUDE CALIBRATOR

Approx 1-kHz squarewave, negative-going. Provides 0.2 V, internally, $\pm 0.7\%$, and 2 V, $\pm 2.7\%$, at Probe Cal jack on front panel.

TEKTRONIX CRT

Rectangular, 4-inch, with 0.8-cm divisions; 8 x 10-div display area. Illuminated internal graticule. 6-kV accelerating potential. External blanking, DC-coupled +2 V and greater will completely blank trace with normal INTENSITY settings. Phosphor is P31.

ENVIRONMENTAL FEATURES—AC MODEL

Temperature: Operating: -15°C to $+55^{\circ}\text{C}$.

Non-operating: -55°C to $+75^{\circ}\text{C}$.

Altitude: Operating: 15,000 ft, maximum.

Non-operating: 50,000 ft, maximum.

Humidity: Non-operating: Meets electrical performance specification after exposure to five cycles (120 hrs) of MIL-STD-202B, Method 106A (omit freezing and vibration, and allow a 24-hour post-test drying period at room ambient conditions of 25, $\pm 5^{\circ}\text{C}$ and 20 to 80% relative humidity).

Vibration: Operating: 15 minutes along each of 3 axes at 0.025 inch peak to peak displacement (4 g's at 55 c/s), 10-55-10 c/s in 1-minute cycles.

Shock: Operating: 30 g's, $\frac{1}{2}$ sine, 11-ms duration, 12 shocks total.

Non-operating: 60 g's, $\frac{1}{2}$ sine, 11-ms duration, 6 shocks total.

EMI: Meets interference requirements of MIL-I-6181D and MIL-I-16910A, Power line conducted: 150 kHz—25 MHz. Radiated (with mesh filter installed): 14 kHz—1000 MHz.

Transportation: National Safe Transit. 1 hour at approx 1 g vibration. 30 inch (18 inch for R422) drop on any corner, edge, or flat surface of the shipping container.

ENVIRONMENTAL FEATURES—AC/DC MODEL, with batteries

Same as AC MODEL, except,

Temperature: Operating: -15°C to $+40^{\circ}\text{C}$

Non-operating: -40°C to $+60^{\circ}\text{C}$

Humidity: With batteries, derate temperature from $+65^{\circ}\text{C}$ to $+60^{\circ}\text{C}$.

422 TYPE R422

POWER OPTIONS

AC Model: 115 V or 230 V $\pm 10\%$, 45 to 440 Hz. Requires approx 40 watts.

AC/DC Model: AC mode: 115 V or 230 V $\pm 20\%$ 45-440 Hz except derate line voltage limits to +10% and -20% from 50 Hz to 45 Hz. Approx 27 W. DC mode: 11.5 V—35 V, approx 23 watts (CONSTANT POWER—2 A max, 650 mA min). Accepts 24 V battery pack.



Panel dust cover provides storage for standard accessories.

DIMENSIONS AND WEIGHTS (Type 422)

Height	6 ¹⁵ / ₁₆ in	17.7 cm
Width	9 ³ / ₈ in	23.8 cm
Depth (including panel cover)		
AC Model	15 ³ / ₄ in	40.0 cm
AC/DC Model	18 ⁹ / ₁₆ in	47.2 cm
Depth (with extended handle)		
AC Model	17 ¹³ / ₁₆ in	45.4 cm
AC/DC Model	20 ⁵ / ₈ in	52.4 cm
Net weight (without front cover)		
AC Model	18 ³ / ₄ lb	8.5 kg
AC/DC Model without batteries	20 ¹ / ₂ lb	9.3 kg
AC/DC Model with batteries	27 ¹ / ₂ lb	12.5 kg
Weight (with front cover and accessories)		
AC Model	21 ¹ / ₄ lb	9.7 kg
AC/DC Model without batteries	23 lb	10.5 kg
AC/DC Model with batteries	30 lb	13.7 kg
Domestic shipping weight		
AC Model	≈30 lb	≈13.6 kg
AC/DC Model without batteries	≈32 lb	≈14.6 kg
Export-packed weight		
AC Model	≈44 lb	≈20.0 kg
AC/DC Model without batteries	≈46 lb	≈20.9 kg

DIMENSIONS AND WEIGHTS (Type R422)

Height	7 in	17.8 cm
Width	19 in	48.3 cm
Depth behind front panel	12 ¹ / ₂ in	31.8 cm
Net weight	23 ¹ / ₄ lb	10.6 kg
Domestic shipping weight	≈50 lb	≈22.7 kg
Export-packed weight	≈73 lb	≈33.2 kg

AC POWERED INSTRUMENTS (PORTABLE)

INCLUDED STANDARD ACCESSORIES

Two P6012 10X probe (010-0203-00); adapter, BNC to binding post (103-0033-00); ornamental ring (354-0248-00); light graticule, smoke gray filter (378-0549-00); clear, CRT protector plate (386-0118-00); mesh filter, installed, (378-0571-00); AC power supply (016-0072-00); 3 to 2-wire adapter (103-0013-00); power cord, 117 V, 3-conductor, right-angle, female with straight male plug (161-0024-01); two instruction manuals (070-0434-01); two instruction manuals (070-0528-00).

(RACKMOUNTS)



OSCILLOSCOPE ON LEFT

Type R422 Oscilloscope (mounted on left side) includes accessories listed for Type 422 above plus slide-out tracks (351-0100-00); and mounting hardware.

OSCILLOSCOPE ON RIGHT, MOD 150E

Type R422 Oscilloscope (mounted on right side) includes accessories listed for Type 422 above plus slide-out tracks (351-0100-00); and mounting hardware.

OSCILLOSCOPES SIDE BY SIDE, MOD 150B

Two Type 422's mounted in a rack-mount panel include two sets of accessories listed for Type 422 above plus slide-out tracks (351-0100-00); and mounting hardware.

OSCILLOSCOPE WITHOUT CABINET, MOD 146B

Type 422 Oscilloscope without cabinet for rackmount conversion includes accessories listed for Type 422.

**AC/DC POWERED INSTRUMENT
(PORTABLE)**

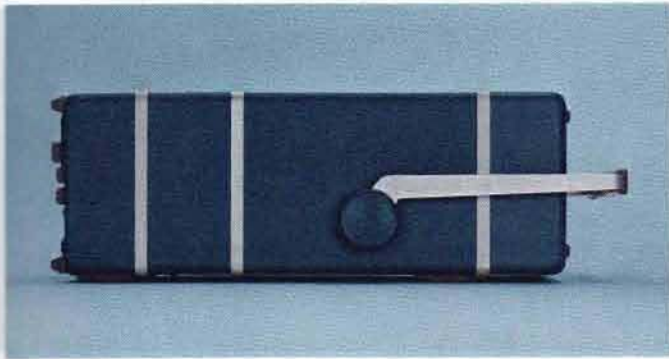

422 MOD 125B (Shown with protective dust cover in place)

INCLUDED STANDARD ACCESSORIES

Type 422 with AC/DC battery power supply, less batteries. Two P6012 10X probe (010-0203-00); ornamental ring (354-0248-00); light graticule, smoke gray filter (378-0549-00); clear, CRT, protector plate (386-0118-00); mesh filter, installed (378-0571-00); AC/DC power supply (016-0073-00); 3 to 2-wire adapter (103-0013-00); 3-wire AC with female connector and male plug power cord (161-0015-01); 3-wire DC with female connector power cord (161-0016-01); BNC to binding post adapter (103-0033-00); two instruction manuals for AC/DC power supply (070-0471-01); two instruction manuals for Type 422 (070-0434-00).

CONVERSION KITS

PORTABLE TO RACK-MOUNT CONVERSION KIT

This mounting kit includes hardware and instructions to convert existing Type 422 Oscilloscopes for rack-mount installation. Order 040-0419-00

RACK-MOUNT TO PORTABLE CONVERSION KIT

This kit includes the cabinet and necessary hardware to convert existing Type R422 Oscilloscopes for portable operation. Order 040-0421-00

OPTIONAL ACCESSORIES

This listing covers only the more commonly used items. The standard probes (10X) supplied with the instrument satisfy most measurement requirements. In addition to the listed optional probes, other probes are available for current and high-voltage measurements. A complete list of accessory items can be found in the catalog accessory pages.

C-30 CAMERA

f/1.9 lens, magnification variable from 1.5:1 to 0.7:1; Polaroid Land* Pack-film back

PROBES

P6007 100X Probe Package, order 010-0150-00

P6011 1X Miniature Probe Package, order 010-0193-00

DUST COVER

Provides protection for Type 422 during transport or storage.

Type 422 (with battery pack) COVER, 016-0075-00

Type 422 (without battery pack) COVER, 016-0076-00

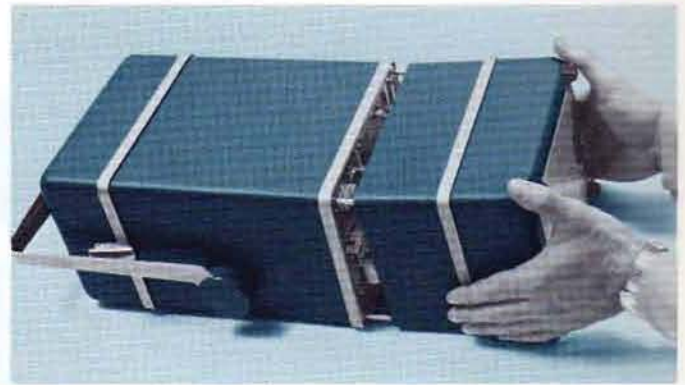

AC/DC POWER SUPPLY WITHOUT BATTERIES

Converts Type 422 Portable Oscilloscope for DC or (with battery pack) battery operation.

Domestic shipping weight 10¹/₄ lbs.

Includes: 3 to 2-wire adapter (103-0013-00); power cord, 3-wire AC w/female connector and male plug (161-0015-01); power cord, 3-wire DC w/female connector (161-0016-01); two instruction manuals (070-0471-00).

Order 016-0073-00

BATTERY PACK FOR TYPE 422 MOD 125B

Order 016-0066-02

COLLAPSIBLE VIEWING HOOD

Permits viewing of trace under high ambient-light conditions, order 016-0082-00



SCOPE-MOBILE® CART

Type 200-2 occupies less than 18 inches aisle space, has storage space in base

*Registered Trade-Mark Polaroid Corporation

Please refer to Terms and Shipment, General Information page.

**DC-to-50 MHz PORTABLE
SWEEP-DELAY OSCILLOSCOPES**

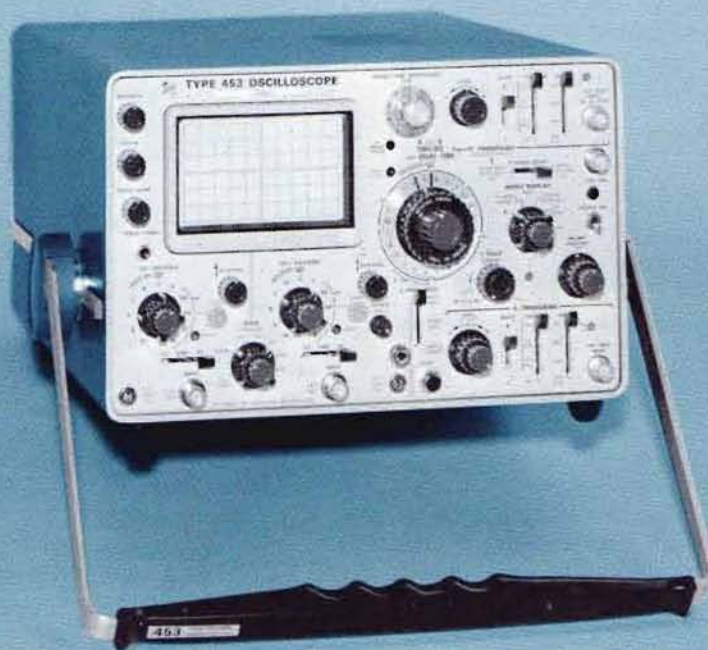

- **7-ns RISETIME WITH OR WITHOUT PROBE**
- **COMPACT, LIGHT WEIGHT**
- **DUAL-TRACE, 5-mV/div DEFLECTION FACTOR**
- **CALIBRATED SWEEP DELAY**
- **FULL-BANDWIDTH TRIGGERING**
- **FULL-SENSITIVITY X-Y DISPLAY**
- **FOR SEVERE ENVIRONMENTS**
- **ILLUMINATED PARALLAX-FREE GRATICULE**

The Type 453 is a portable, wide-band, dual-trace oscilloscope designed to withstand rough transport and other environmental extremes. Bandwidth of the Type 453 is DC to 50 MHz (with or without supplied probes). Probes are miniaturized for easy access to dense circuitry.

The sharply-focused, bright trace provides a high-definition display compatible with the wide-band capabilities of the Type 453.

Solid-state design, with FET inputs, provides low drift and fast stabilization time.

Mechanical design features include plug-in transistors (for ease of maintenance), a front-panel cover (for use in transit or storage) with storage space for accessory items, and a carrying handle which can be rotated to several positions as a tilt-stand or for convenient carrying.

Channel 1 can be switched to give horizontal deflection with Channel 2 providing the vertical deflection, enabling full-sensitivity X-Y displays (to 5 mV/div).

Type R453 is electrically identical to Type 453. It mounts on tilting, slide-out tracks to a standard 19-inch rack, requiring only 7 inches of vertical rack-space.

CHARACTERISTIC SUMMARY

VERTICAL

(2 Identical Channels)

BANDWIDTH & RISETIME

10 V/div to 20 mV/div: DC to 50 MHz, 7 ns

10 mV/div: DC to 45 MHz, 7.8 ns

5 mV/div: DC to 40 MHz, 8.75 ns

CALIBRATED DEFLECTION FACTOR—5 mV/div to 10 V/div.

50 mV/div to 100 V/div with P6010 Probe.

INPUT RC—1 megohm paralleled by approx 20 pF.

HORIZONTAL

CALIBRATED TIME BASE—0.1 μ s/div to 5 s/div.

X10 MAGNIFIER—Operates over full time base, increases fastest rate to 10 ns/div.

CALIBRATED SWEEP DELAY—1 μ s to 50 s.

EXTERNAL INPUT—270 mV/div to 2.7 V/div, or Channel 1 can drive HORIZONTAL.

CRT

DISPLAY AREA—6 x 10 div (0.8 cm/div).

ACCELERATING VOLTAGE—10 kV.

PHOSPHOR—P31.

OTHER

AMPLITUDE AND TIME CALIBRATOR—1 V or 0.1 V output; 5 mA output; 1-kHz squarewave.

POWER REQUIREMENTS—90 to 136 V or 180 to 272 V, 48 to 440 Hz, approx 92 watts.

VERTICAL DEFLECTION

(2 identical channels)

BANDWIDTH* AND RISETIME	
DEFLECTION FACTOR**	FROM 50-Ω TERMINATED SOURCE WITH OR WITHOUT P6010 PROBE
10 V/div to 20 mV/div	DC to at least 50 MHz, 7 ns
10 mV/div	DC to at least 45 MHz, 7.8 ns
5 mV/div	DC to at least 40 MHz, 8.75 ns
1 mV/div Ch 1 & 2 Cascaded	DC to at least 25 MHz, 14 ns

*Measured at 3-dB down. Lower 3-dB point, AC coupled is approx 1.6 Hz [approx 0.16 Hz with P6010 10X Probe].

**Without P6010 10X Probe. Deflection factor with P6010 is 10X panel reading.

DEFLECTION FACTOR (EACH CHANNEL)

5 mV/div to 10 V/div in 11 calibrated steps (1-2-5 sequence), accurate within 3%. Uncalibrated continuously variable between steps and to ≈ 25 V/div. Warning lights indicate uncalibrated settings.

INPUT RC

1 megohm $\pm 2\%$ paralleled by 20 pF $\pm 3\%$.

MAXIMUM INPUT VOLTAGE

600 V combined DC + peak AC.

OPERATING MODES

Channel 1 only; Channel 2 only (normal or inverted); Added algebraically (common-mode rejection ratio $\geq 20:1$ at 20 MHz with up to 8 divisions of common-mode signal at 20 mV/div); Alternate; Chopped at a 500 kHz ($\pm 20\%$) rate.

TRACE DRIFT		
DEFLECTION FACTOR	TIME	TEMPERATURE
5 mV/div	less than 0.08 div/h	less than 0.02 div/°C
10 mV/div	less than 0.05 div/h	less than 0.0125 div/°C
20 mV/div through 10 V/div	less than 0.03 div/h	less than 0.0075 div/°C

DELAY LINE

Permits viewing of leading edge of triggering waveform.

SIGNAL OUTPUT

Channel 1 Vertical Signal: ≥ 25 mV/div into 1 megohm; approx 50-Ω output resistance; DC to ≥ 25 MHz (-3 dB).

INTERNAL TRIGGER SOURCE

Normal (displayed signal) or Channel 1 signal only picked off ahead of channel switching.

HORIZONTAL DEFLECTION

TIME BASE A

0.1 μ s/div to 5 s/div in 24 calibrated steps (1-2-5 sequence). Uncalibrated continuously variable between steps and to ≥ 12.5 s/div. Warning light indicates uncalibrated setting. Sweep length continuously variable from ≤ 4 div to 11.0 ± 0.5 div.



Type R453 Oscilloscope

TIME BASE B

0.1 μ s/div to 0.5 s/div in 21 calibrated steps (1-2-5 sequence). Uncalibrated continuously variable between steps and to ≥ 1.25 s/div. Warning light indicates uncalibrated setting.

TIME BASE A & B SWEEP ACCURACY		
SWEEP RANGE	0°C to 40°C	-15°C to +55°C
0.1 μ s/div to 50 ms/div	$\pm 3\%$	$\pm 4\%$
0.1 s/div to 5 s/div	$\pm 3\%$	$\pm 5\%$

X10 MAGNIFIER

Operates over full time base, increases fastest rate to 10 ns/div. Magnified display accurate within 1% in addition to specified basic sweep accuracy.

TIME BASE A SWEEP MODES

Auto Trigger—sweep free runs in absence of triggering signal; Normal Trigger; Single Sweep. Light indicates when sweep is triggered.

TIME BASE B SWEEP MODES

Time Base B Triggerable after delay time; Time Base B starts after delay time.

TRIGGER

TIME BASE A & B TRIGGER SENSITIVITY			
TRIGGER MODE	TO 10 MHz	AT 50 MHz	
DC	INTERNAL	≤ 0.2 div deflection	≤ 1 div deflection
	EXTERNAL	≤ 50 mV	≤ 200 mV
AC	As above, except -3 dB at 16 Hz		
AC LF REJECT	As above, except -3 dB at 16 kHz		
AC HF REJECT	As above, except -3 dB at 16 Hz and 100 kHz		

SOURCES

Internal, Line, External, External $\div 10$.
Input RC approx 1 megohm paralleled by approx 20 pF (except in AC LF Reject mode). 600 volts maximum input (DC + peak AC). Level adjustment through $\geq \pm 2$ volts in External, through $\geq \pm 20$ volts in External $\div 10$.

X-Y OPERATION

FULL-SENSITIVITY X-Y (CH 1 HORIZ, CH 2 VERT)

5 mV/div to 10 V/div in 11 calibrated steps (1-2-5 sequence), accurate within 5% from 0°C to +40°C within 8% from -15°C to +55°C; no variable on Ch 1. Bandwidth is DC to ≥ 5 MHz (-3 dB). Phase difference between amplifiers is $\leq 3^\circ$ at 50 kHz.

HORIZONTAL AMPLIFIER (EXTERNAL INPUT)

270 mV/div $\pm 15\%$ in External, 2.7 V/div $\pm 20\%$ in External $\div 10$. Same bandwidth and phase difference as above.

CALIBRATED SWEEP DELAY

DELAY TIME RANGE

1 μ s to 50 s, continuously variable with 10-turn multiplier.

DELAY ACCURACY

DELAY	0°C to +40°C	-15°C to +55°C
1 μ s/div to 50 ms/div	$\pm 1.5\%$	$\pm 2.0\%$
0.1 s/div to 5 s/div	$\pm 2.5\%$	$\pm 3.5\%$

MULTIPLIER INCREMENTAL LINEARITY

Included in delay accuracy: $\pm 0.2\%$ from 0°C to +40°C, $\pm 0.3\%$ from -15°C to +55°C.

JITTER

≤ 1 part in 20,000 of 10X Time Base A Time/div setting.

ENVIRONMENTAL CAPABILITIES

TEMPERATURE

Operating: -15°C to +55°C.
Non-operating: -55°C to +75°C.

ALTITUDE

Operating: 15,000 feet; maximum allowable ambient temperature decreased 1°C/1000 feet from 5,000 to 15,000 feet.
Non-operating: 50,000 feet.

VIBRATION

Operating: 15 minutes along each of the three axes, 0.025 inch peak to peak displacement (4 g's at 55 c/s) 10 to 55 to 10 c/s in 1-minute cycles.

SHOCK

Operating and non-operating: 30 g's, $\frac{1}{2}$ sine, 11-ms duration, 2 shocks per axis in each direction for a total of 12 shocks.

ELECTROMAGNETIC INTERFERENCE (Type 453 MOD 163D and R453 MOD 163D only)

Meets interference requirements of MIL-I-6181D and MIL-I-16910C, power line conducted: 150 kHz to 30 MHz, radiated (with mesh filter installed): 14 kHz to 1 GHz.

HUMIDITY

Non-operating: Meets electrical performance specifications after exposure to five cycles (120 hours) of Mil-Std-202C, Method 106B (omit freezing and vibration, and allow a post-test drying period at +25°C $\pm 5^\circ$ C and 20% to 80% relative humidity).

TRANSPORTATION

In shipping carton: Meets National Safe Transit test of vibration for 1 hour at slightly greater than 1 g, 30-inch (18-inch for R453) drop on any corner, edge, or flat surface of the shipping container.

CRT

TEKTRONIX CRT

4-inch rectangular tube; 6 x 10 div (each div = 0.8 cm) display area; P31 phosphor standard. 10-kV accelerating potential. Z-axis input DC coupled to CRT cathode; noticeable modulation at normal intensity with 5 volts or less peak to peak; DC to ≥ 50 MHz usable frequency range; 200 volts (DC and peak AC) maximum input voltage.

GRATICULE

Internal, parallax-free; variable edge lighting.

TRACE FINDER

Compresses display to within graticule area, for ease in determining the location or relative magnitude of an off-screen signal.

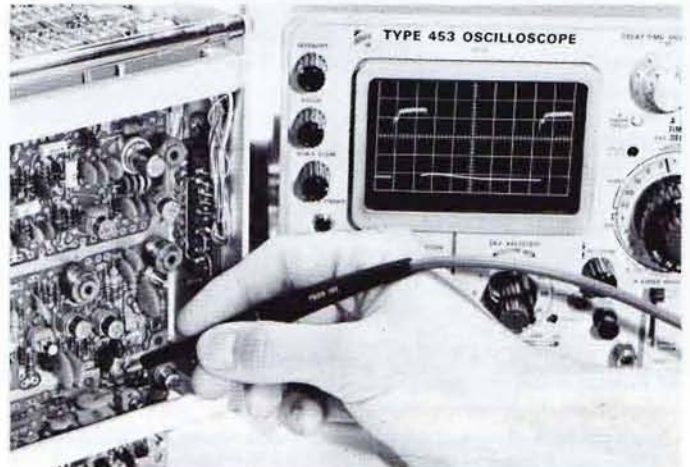

Small probe for easy access to dense circuitry.

OTHER CHARACTERISTICS

AMPLITUDE AND TIME CALIBRATOR

1 volt or 0.1 volt output; 5-mA output. Amplitude accurate within 1% from 0°C to +40°C, within 1.5% from -15°C to +55°C. 1-kHz squarewave, repetition rate accurate within 0.5% from 0°C to +40°C, within 1% from -15°C to +55°C. ≤ 1 - μ s risetime; 49% to 51% duty cycle.

SIGNAL OUTPUTS

A and B Gates: 12 volts $\pm 10\%$, approx 1.5-k Ω output resistance.

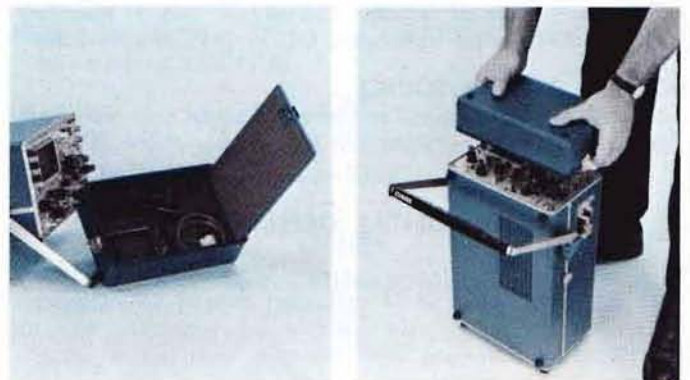

Panel dust cover provides storage for standard accessories.

POWER REQUIREMENTS

Quick-change line-voltage selector provides 6 ranges: 90 to 110 V, 104 to 126 V, 112 to 136 V, 180 to 220 V, 208 to 252 V, and 224 to 272 V. 48 to 440 Hz, 92 watts maximum at 115 V and 60 Hz.

COOLING

Filtered forced-air cooling.

DIMENSIONS AND WEIGHTS (Type 453)

Height	7 $\frac{1}{4}$ in	18.4 cm
Width	12 $\frac{1}{2}$ in	30.8 cm
Depth (including panel cover)	20 $\frac{1}{2}$ in	52.0 cm
Depth (with extended handle)	22 $\frac{3}{8}$ in	56.8 cm
Net weight (without panel cover)	27 $\frac{3}{4}$ lb	12.6 kg
Weight (with panel cover and accessories)	30 lb	13.6 kg
Weight (with dust and rain cover, power cord, and one instruction manual)	32 lb	14.6 kg
Domestic shipping weight	\approx 42 lb	\approx 19.1 kg
Export-packed weight	\approx 54 lb	\approx 24.6 kg

DIMENSIONS AND WEIGHTS (Type R453)

Height	7 in	17.8 cm
Width	19 in	48.2 cm
Depth (behind front panel)	17 $\frac{3}{4}$ in	45.0 cm
Net weight	32 $\frac{1}{4}$ lb	14.7 kg
Domestic shipping weight	\approx 63 $\frac{1}{2}$ lb	\approx 28.8 kg
Export-packed weight	\approx 87 lb	\approx 39.6 kg

INCLUDED STANDARD ACCESSORIES

Two P6010 3.5 ft 10X probe package (010-0188-00); 18-inch 50- Ω BNC cable (012-0076-00); BNC jack post (012-0092-00); 3 to 2-wire adapter (103-0013-00); CRT ornamental ring (354-0269-00); smoke gray light filter (378-0576-00); mesh filter (installed) (378-0573-00); CRT face-plate protector (386-0218-00); oscilloscope dust and rain cover (016-0074-01); two BNC to binding post adapters (103-0033-00); five fuses, assorted spares; two instruction manuals (070-0755-00). Accessories for R453 are the same as for Type 453 less dust and rain cover, but also includes: mounting hardware; slide-out tracks (351-0101-00).

CONVERSION KIT

PORTABLE TO RACK-MOUNT

Includes hardware and instructions to convert existing Type 453 Portable Oscilloscopes for rack-mount installation.
Order 040-0446-01

TYPE 453 MOD 163D

Includes the features of the standard Type 453 and R453, and in addition meets electromagnetic interference requirements of MIL-I-6181D and MIL-I-16910C; Power line conducted: 150 kHz to 30 MHz; Radiated (with mesh filter installed): 14 kHz to 1 GHz.



TYPE 453 MOD 165M

The Type 453 MOD 165M is watertight (as defined in MIL-STD-108E). A watertight front-panel cover provides storage space for accessory items. The sealed case prevents rupture due to altitude changes and a special vent permits manual equalization when outside pressure differs from inside pressure. Ports on side panel and rear panel cover seldom-used switches and connectors.

ELECTROMAGNETIC INTERFERENCE

Meets interference requirements of MIL-1-6181D and MIL-1-16910A, power line conducted: 150 kHz to 25 MHz, radiated (with mesh filter installed): 14 kHz to 1 GHz.

WATERTIGHT CAPABILITY

Meets the requirements stated in MIL-STD-108E.



Type 453 MOD 165M with watertight front-panel cover in place.

DIMENSIONS and WEIGHTS

Height	10 $\frac{3}{8}$ in	26.3 cm
Width	14 $\frac{1}{4}$ in	36.2 cm
Depth (including panel cover)	22 $\frac{1}{2}$ in	57.2 cm
Depth (with extended handle)	26 in	66.0 cm
Weight (with panel cover and accessories)	\approx 44 lb	\approx 20.0 kg
Domestic shipping weight	\approx 57 lb	\approx 25.8 kg
Export-packed weight	\approx 71 lb	\approx 32.2 kg

INCLUDED STANDARD ACCESSORIES

Same as listed for Type 453.

TYPE 453 R453

CONVERSION KIT

TYPE 453 TO TYPE 453 MOD 165M

This kit includes the necessary hardware and instructions to convert a Type 453 to a Type 453 MOD 165M.

Order 040-0473-00

TYPE 453 AND R453 MOD 127C

An internal TV Sync Separator circuit permits stable internal Line or Field-rate triggering from displayed composite video or composite sync waveforms. External $\div 10$ trigger sources are replaced by internal TV Sync positions providing Line (Horizontal) sync pulses to the B Sweep circuit and either Field (Vertical) or Line sync pulses to the A Sweep circuit.

Individual line selection of VIT (vertical interval test) signals is facilitated by the sweep delay features in the Type 453. The wide range of sweep delays permit accurate alternate-frame color-burst observations in the PAL color system.

Conventional waveform displays and measurements can be made from standard broadcast or closed-circuit TV systems, domestic or overseas, with up to 1201-line, 60-Hz field rates. Other characteristics are the same as Type 453 and R453.

INCLUDED STANDARD ACCESSORIES

Same as Type 453 except as follows: delete two P6010 3.5 ft 10X probe packages (010-0188-00), add two P6010 6 ft probe packages (010-0185-00), two 6-32 adapters (103-0051-000), two spring phone tip adapters (206-0060-00), one snap-in light filter/TV graticule with 140-unit IRE scale.

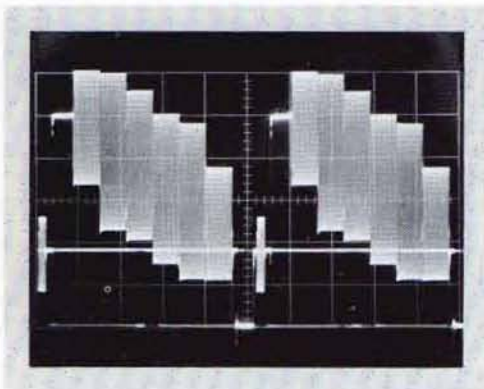

NTSC color bar test signal displayed on the Type 453 MOD 127C.

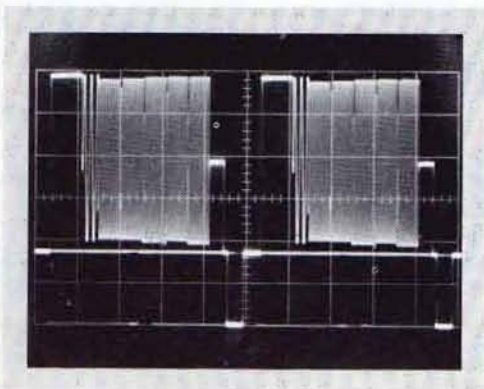

Multiburst test signal displayed on the Type 453 MOD 127C.

OPTIONAL ACCESSORIES

Optional accessories serve to extend the usefulness of the Type 453 in certain applications. This list covers only the more commonly used items. The standard probes (10X) supplied with the instrument satisfy most measurement requirements. In addition to the listed optional probes, other probes are available for current and high-voltage measurements. See catalog accessory pages.

COLLAPSIBLE VIEWING HOOD

Permits viewing of trace under high ambient-light conditions.
Order 016-0083-00



The Type 453 with the Tektronix C-30.

C-30 CAMERA

f/1.9 lens, magnification variable from 1.5:1 to 0.7:1; Polaroid Land* Pack-Film back for 3000-speed film

PROBES

P6010 6 ft 10X Probe Package, order 010-0185-00

P6011 3.5 ft 1X Probe Package, order 010-0193-00

P6019 Current Probe with passive termination, 2 mA/mV or 10 mA/mV, 120 Hz to 60 MHz, order 015-0065-00

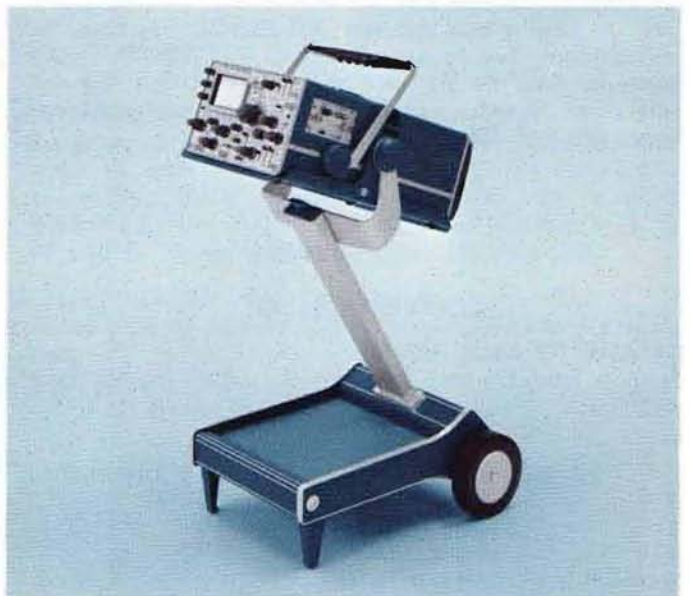

SCOPE-MOBILE® CART

Type 200-1 occupies less than 18 inches aisle space, has storage space at base

*Registered Trade-Mark Polaroid Corporation

Please refer to Terms and Shipment, General Information page.

**DC-to-150 MHz PORTABLE
SWEEP-DELAY OSCILLOSCOPES**

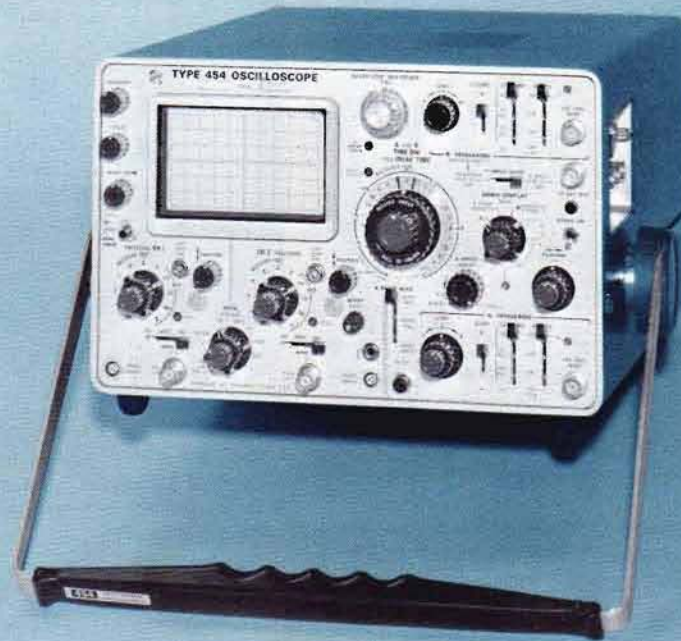

- **2.4-ns RISETIME WITH OR WITHOUT PROBE**
- **HIGH-WRITING-SPEED CRT**
- **DUAL-TRACE, 5-mV/div DEFLECTION FACTOR**
- **FULL-BANDWIDTH TRIGGERING**
- **CALIBRATED SWEEP DELAY**
- **FULL-SENSITIVITY X-Y DISPLAYS**
- **COMPACT, RUGGED CONSTRUCTION**
- **SOLID STATE DESIGN**

The Type 454 offers convenient measurement of fast-rise pulses and high-frequency signals previously beyond the capability of most conventional real-time oscilloscopes. Rise time is 2.4 ns, bandwidth is 150 MHz, with or without probe.

The two channels of the Type 454 provide cascaded single-trace displays at 1 mV/div, and also provide X-Y displays to 5 mV/div. The dual-trace vertical system displays either channel separately, adds channels algebraically, alternates between channels, or chops between channels at a 1-MHz rate.

A time-base system with calibrated sweep delay permits highly-magnified displays of small portions of undelayed sweeps, accurate measurement of waveform time jitter, precise time measurements, and many other measurement uses.

The Type 454 is mechanically designed to withstand environmental extremes and rough handling in transit. Plug-in transistors provide ease of maintenance.

Type R454 (the rackmount model) is electrically identical to Type 454, but is mechanically designed to mount on tilting slide-out tracks in a standard 19-in rack.

CHARACTERISTIC SUMMARY

VERTICAL

(2 identical channels)

BANDWIDTH & RISETIME

10 V/div to 20 mV/div: DC to 150 MHz, 2.4 ns
10 mV/div: DC to 100 MHz, 3.5 ns
5 mV/div: DC to 60 MHz, 5.9 ns

CALIBRATED DEFLECTION FACTORS—5 mV/div to 10 V/div, 11 steps; 50 mV/div to 100 V/div with P6047 Probe.

INPUT RC—1 megohm paralleled by 20 pF.

HORIZONTAL

CALIBRATED TIME BASE—0.05 μ s/div to 5 s/div, 24 steps.

TRIGGERING—DC to 150 MHz.

X10 MAGNIFIER—Operates over full time base, increases fastest rate to 5 ns/div.

CALIBRATED SWEEP DELAY—1 μ s to 50 s.

X-Y OPERATION—5 mV/div to 10 V/div, DC to 2 MHz.

CRT

DISPLAY AREA—6 x 10 div (0.8 cm/div), internal graticule.

ACCELERATING VOLTAGE—14 kV.

PHOSPHOR—P31.

OTHER

AMPLITUDE AND TIME CALIBRATOR—1 V, 5 mA; 1 kHz.

PROBE POWER—2 connectors for P6045 FET Probe power.

POWER REQUIREMENTS—90 to 136 V and 180 to 272 V in six ranges; range selection via quick-change switching device. 48 to 440 Hz, approx 125 watts.

VERTICAL DEFLECTION SYSTEM

(2 identical channels)

BANDWIDTH* AND RISE TIME (0°C to +40°C)

DEFLECTION FACTOR**	FROM 50-Ω TERMINATED SOURCE	
	with or without P6047 PROBE	WITH P6045 FET PROBE
10 V/div to 20 mV/div	150 MHz and 2.4 ns	130 MHz and 2.7 ns
10 mV/div	100 MHz and 3.5 ns	95 MHz and 3.7 ns
5 mV/div	60 MHz and 5.9 ns	58 MHz and 6 ns
1 mV/div Ch 1 & 2 Cascaded	33 MHz and 11 ns	33 MHz and 11 ns

*Measured at 3-dB down. Lower 3-dB point, AC coupled is less than 10 Hz (less than 1 Hz with P6047 10X Probe).

**Without P6047 10X Probe. Deflection factor with P6047 is 10X panel reading.

PROBE DATA—P6047 10X Passive Probe (supplied with Type 454): 10X attenuation, 10 megohms input resistance, and 10 pF input capacitance. P6045 1X FET Active Probe (extra-cost option): 1X attenuation, 10 megohms input resistance, and less than 4 pF input capacitance. See catalog accessory page for additional data.

PROBE POWER

Two connectors provide correct operating voltages for two P6045 FET Probes.

TRACE FINDER—5-MHz BANDWIDTH SWITCH

Down position compresses display to within graticule area for convenient trace location. Up position limits bandwidth of main vertical amplifier to between 4 and 6 MHz for noise and interference reduction at higher sensitivities. Center position provides normal operation.

DEFLECTION FACTOR (2 identical channels)

5 mV/div to 10 V/div in 11 calibrated steps (1-2-5 sequence), accurate within $\pm 3\%$. Continuously variable (uncalibrated) between steps and to approx 25 V/div. Warning lights indicate uncalibrated settings.

INPUT RC

1 megohm $\pm 2\%$, paralleled by 20 pF ± 1 pF.

MAXIMUM INPUT VOLTAGE

600 V combined DC + peak AC.

OPERATING MODES

Channel 1 only; Channel 2 only (normal or inverted); Added algebraically (common-mode rejection ratio $\geq 10:1$ at 50 MHz with up to 8 divisions of common-mode signal at 20 mV/div); Alternate; Chopped at 1 MHz ($\pm 20\%$).

TIME DELAY BETWEEN CHANNELS

Less than 0.25 ns.

DELAY LINE

Permits viewing leading edge of triggering waveform.

SIGNAL OUTPUT

Channel 1 vertical output: ≥ 25 mV per division of Channel 1 display (into 1 megohm); approx 30-Ω output resistance; DC to ≥ 33 MHz (3-dB down).

INTERNAL TRIGGER SOURCE

Normal (displayed signal) or Ch 1 signal only picked off ahead of channel switching.

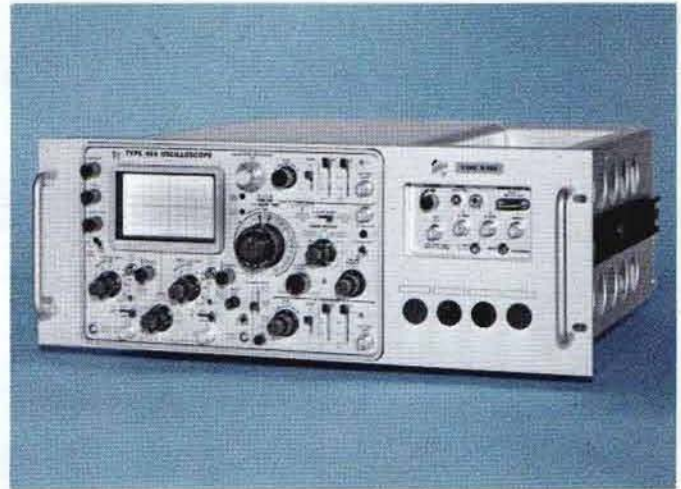

HORIZONTAL DEFLECTION SYSTEM

TIME BASE A

0.05 μ s/div to 5 s/div in 25 calibrated steps (1-2-5 sequence). Continuously variable (uncalibrated) between steps and to approx 12.5 s/div. Warning light indicates uncalibrated setting. Sweep length continuously variable from ≤ 4 div to 11.0 div ± 0.5 div.

TIME BASE B

0.05 μ s/div to 0.5 s/div in 22 calibrated steps (1-2-5 sequence). Continuously variable (uncalibrated) between steps and to approx 1.25 s/div. Warning light indicates uncalibrated setting.

X10 MAGNIFIER

Operates over full time base, increases fastest rate to 5 ns/div.

TIME BASE A & B SWEEP ACCURACY

SWEEP TIME/DIV	0°C to +40°C		-15°C to +55°C	
	Normal	Magnified	Normal	Magnified
0.05 μ s			$\pm 4\%$	$\pm 6\%$
0.1 μ s to 50 ms	$\pm 3\%$	$\pm 4\%$	$\pm 4\%$	$\pm 5\%$
0.1 s to 5 s			$\pm 5\%$	$\pm 6\%$

HORIZONTAL-DISPLAY MODES

Time Base A only, A Intensified During B, B (delayed sweep), and X-Y (switches Channel 1 to drive X axis).

TIME BASE A SWEEP MODES

Repetitive sweep with automatic triggering, repetitive sweep with normal triggering, or single sweep for photographic recording. Light indicates when sweep is triggered.

TIME BASE B SWEEP MODES

Time Base B triggerable after delay time, or Time Base B runs automatically at end of delay time.

X-Y OPERATION

FULL-SENSITIVITY X-Y (CH 1 HORIZ, CH 2 VERT)

5 mV/div to 10 V/div in 11 calibrated steps (1-2-5 sequence), accurate within $\pm 3\%$; no variable on Ch 1. X bandwidth is DC to ≥ 2 MHz (3-dB down). Phase difference between amplifiers is $\leq 3^\circ$ from DC to 2 MHz.

CALIBRATED SWEEP DELAY

DELAY TIME RANGE

1 μ s to 50 s, continuously variable with 10-turn, calibrated multiplier.

JITTER

≤ 1 part in 20,000 of maximum delay.

DELAY ACCURACY		
TIME/DIV SETTING	0°C to +40°C	-15°C to +55°C
1 μs/div to 50 ms/div	± [1.5 + $\frac{2}{\Delta\text{DTM}^*}$] %	± [2 + $\frac{3}{\Delta\text{DTM}^*}$] %
0.1 s/div to 5 s/div	± [2.5 + $\frac{2}{\Delta\text{DTM}^*}$] %	± [3.5 + $\frac{3}{\Delta\text{DTM}^*}$] %

*ΔDTM is the difference in the setting of the Delay Time Multiplier control, expressed in major divisions.

TRIGGERING

MODES

Automatic or Normal on Time Base A. Automatic operation useful between 20 Hz and 150 MHz, minimizes trigger adjustments for signals of different amplitudes, shapes and repetition rates. With no input (or input less than 20 Hz), the automatic triggering free runs the sweep and provides a bright reference trace at all sweep rates. Normal triggering only on Time Base B. With sweep delay, Time Base B can be set to run at end of delay period, or to be triggerable at end of delay period.

COUPLING, TIME BASE A & B

AC, DC, AC Low-Frequency Reject, or AC High-Frequency Reject.

SOURCES, TIME BASE A & B

Internal, External, External ÷ 10, or Line. 500-V maximum input (DC + peak AC). Level adjustment through at least ± 2 volts in External, through at least ± 20 volts in External ÷ 10.

SIGNAL REQUIREMENTS, TIME BASE A & B

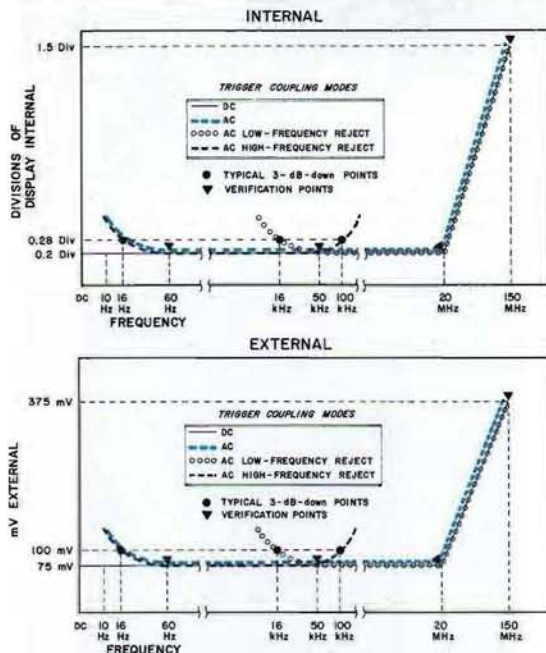

CONVENIENT SWITCH LOGIC

Trigger switches are arranged with the up position providing the most commonly used set of trigger functions: Automatic mode, + slope, AC coupling and Internal source.

ENVIRONMENTAL CAPABILITIES

(Oscilloscope and P6047 Probe)

TEMPERATURE

Operating: -15°C to +55°C. Nonoperating: -35°C to +75°C.

ALTITUDE

Operating: To 15,000 feet; maximum allowable ambient temperature decreased by 1°C/1000 feet from 5,000 to 15,000 feet. Nonoperating: to 50,000 feet.

VIBRATION

Operating: 15 minutes along each of the three axes, 0.025 inch peak-to-peak displacement (4 g's at 55 c/s) 10 to 55 to 10 c/s in 1-minute cycles.

SHOCK

Operating and nonoperating: 30 g's, 1/2 sine, 11-ms duration, 2 shocks per axis in each direction for a total of 12 shocks.

ELECTROMAGNETIC INTERFERENCE (Type 454 MOD 163D and R454 MOD 163D only)

Meets interference requirements of MIL-I-6181D and MIL-I-16910C, power line conducted: 150 kHz to 30 MHz, radiated (with mesh filter installed): 14 kHz to 1 GHz.

HUMIDITY

Non-operating: Meets electrical performance specifications after exposure to five cycles (120 hours) of Mil-Std-202C, Method 106B (omit freezing and vibration, and allow a post-test drying period at +25°C ± 5°C and 20% to 80% relative humidity).

TRANSPORTATION

Meets National Safe Transit test when factory-packaged: Vibration for one hour at slightly greater than one g. Drop on any corner, edge or flat surface; 18-in drop for Type R454, 30-in drop for Type 454.

CRT

TEKTRONIX CRT

4-in rectangular tube; 6 x 10 div display area, each div is 0.8 cm, horizontal and vertical centerlines further marked in 0.2-div increments. P31 phosphor normally supplied. 14-kV accelerating potential. Z-axis input DC coupled to CRT cathode; noticeable modulation at normal intensity with 5-V peak-to-peak signal; DC to 50 MHz usable frequency range.

GRATICULE

Internal, no parallax; variable edge lighting.

PHOTOGRAPHIC WRITING SPEED (without Film Fogging Techniques)					
Camera and Phosphor					Minimum Photographic Writing Speed
Camera	Lens	Object-to-image ratio	Polaroid* film type	CRT Phosphor	
C40	f1.3	1:0.5	410 (10,000 ASA)	P31	1250 div/μs (1000 cm/μs)
				P11	2500 div/μs (2000 cm/μs)
C30	f1.9	1:0.7	107 (3,000 ASA)	P31	182 div/μs (146 cm/μs)

*Registered Trade-Mark, Polaroid Corporation.

TYPE 454 R454

OTHER CHARACTERISTICS

AMPLITUDE AND TIME CALIBRATOR

1 V and 5 mA at external jacks; accurate within 1% from 0°C to +40°C, and within 1.5% from -15°C to +55°C. 1-kHz repetition rate accurate within 0.5% from 0°C to +40°C, and within 1% from -15°C to +55°C. Rise time $\leq 1 \mu\text{s}$, duty cycle 49% to 51%, output resistance $250 \Omega \pm 1\%$.

SIGNAL OUTPUTS

Positive gates from both time bases ($12.6 \text{ V} \pm 10\%$), and a positive-going sawtooth from Time Base A ($10 \text{ V} \pm 10\%$).

POWER REQUIREMENTS

Quick-change line-voltage selector provides six ranges: 90 to 110 V, 104 to 126 V, 112 to 136 V, 180 to 220 V, 208 to 252 V, and 224 to 272 V. 48 to 440 Hz, 125 watts maximum at 115 V and 60 Hz.

COOLING

Filtered, forced-air ventilation.



Panel dust cover provides storage for standard accessories.

TYPE 454 DIMENSIONS AND WEIGHTS

Height	7 $\frac{1}{4}$ in	18.4 cm
Width	12 $\frac{1}{2}$ in	30.8 cm
Depth (incl. panel cover)	20 $\frac{1}{2}$ in	52 cm
Depth (handle extended)	22 $\frac{3}{8}$ in	56.8 cm
Net weight (w/o panel cover)	29 $\frac{1}{4}$ lb	12.7 kg
Net weight (with panel cover and accessories)	31 $\frac{1}{4}$ lb	13.6 kg
Domestic shipping weight	≈ 43 lb	≈ 18.7 kg
Export-packed weight	≈ 57 lb	≈ 24.8 kg

TYPE R454 DIMENSIONS AND WEIGHTS

Height	7 in	17.8 cm
Width	19 in	48.3 cm
Depth (behind front panel)	17 $\frac{3}{4}$ in	45 cm
Net weight	33 $\frac{1}{2}$ lb	14.5 kg
Domestic shipping weight	≈ 65 lb	≈ 28.2 kg
Export-packed weight	≈ 86 lb	≈ 37.4 kg

INCLUDED STANDARD ACCESSORIES

Two P6047 Probes with accessories (010-0211-00); 50- Ω 18-in BNC cable (012-0076-00); BNC jack post (012-0092-00); 3 to 2-wire power-cord adapter (103-0013-00); CRT ornamental ring (354-0269-00); light filter, smoke gray (378-0576-00); mesh filter (installed) 378-0573-00; CRT faceplate protector (386-0218-00); two BNC binding-post adapters (103-0033-00); dust and rain cover (016-0074-01); two instruction manuals (070-0617-00); four fuses, assorted spares.

CONVERSION KIT

PORTABLE TO RACK-MODEL

Includes hardware and instructions to convert existing Type 454 Portable Oscilloscopes for rack-mount installation.

Order 040-0446-01

TYPE 454 MOD 163D

Includes the features of the standard Type 454 and R454, and in addition meets electromagnetic interference requirements of MIL-I-6181D and MIL-I-16910C; Power line conducted: 150 kHz to 30 MHz; Radiated (with mesh filter installed): 14 kHz to 1 GHz.



TYPE 454 MOD 165M

The Type 454 MOD 165M is watertight (as defined in MIL-STD-108D). A watertight front-panel cover provides storage space for accessory items. The sealed case prevents rupture due to altitude changes and a special vent permits manual equalization when outside pressure differs from inside pressure. Ports on side panel and rear panel cover seldom-used switches and connectors.

ELECTROMAGNETIC INTERFERENCE

Meets interference requirements of MIL-I-6181D and MIL-I-16910A, power line conducted: 150 kHz to 25 MHz, radiated (with mesh filter installed): 14 kHz to 1 GHz.

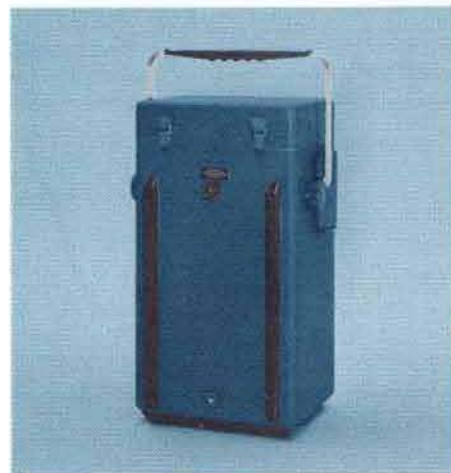

Type 454 Mod 165M with watertight front-panel cover in place.

WATERTIGHT CAPABILITY

Meets the requirements stated in MIL-STD-108E.

DIMENSIONS and WEIGHTS

Height	10 ³ / ₈ in	26.3 cm
Width	14 ¹ / ₄ in	36.2 cm
Depth (including panel cover)	22 ¹ / ₂ in	57.2 cm
Depth (with extended handle)	26 in	66.0 cm
Weight (with panel cover and accessories)	≈ 48 ¹ / ₄ lb	≈ 20.9 kg
Domestic shipping weight	≈ 60 lb	≈ 27.3 kg
Export-packed weight	≈ 74 lb	≈ 33.6 kg

INCLUDED STANDARD ACCESSORIES

Same as listed for Type 454.

CONVERSION KIT

TYPE 454 TO TYPE 454 MOD 165M

This kit includes the necessary hardware and instructions to convert a Type 454 to a Type 454 MOD 165M.
Order 040-0478-00

OPTIONAL ACCESSORIES

Optional accessories increase measurement capability and provide added convenience. The standard probes supplied with the instrument satisfy most measurement requirements; optional probes, including high-voltage and current-measuring probes, may be better suited for particular applications. See catalog accessory pages.

C-30 COMPACT CAMERA

f/1.9 lens, magnification variable from 1.5:1 to 0.7:1, Polaroid Land* Pack-Film back for 3000-speed film

PROBES

P6045 1X FET Probe Package, order 010-0204-00

P6020 Current Probe with passive termination, order 015-0066-00

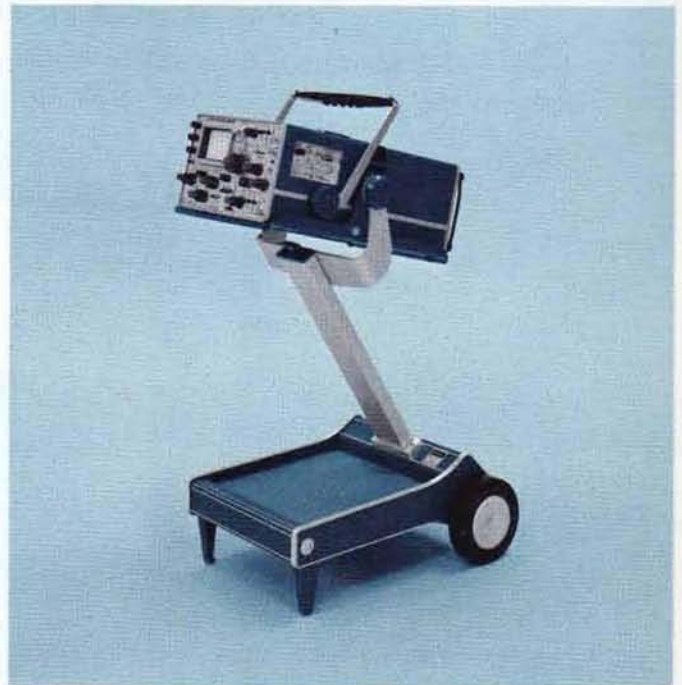

SCOPE-MOBILE® CART

200-1 is small and compact for easy maneuvering

*Registered Trade-Mark, Polaroid Corporation.

Please refer to Terms and Shipment, General Information page.

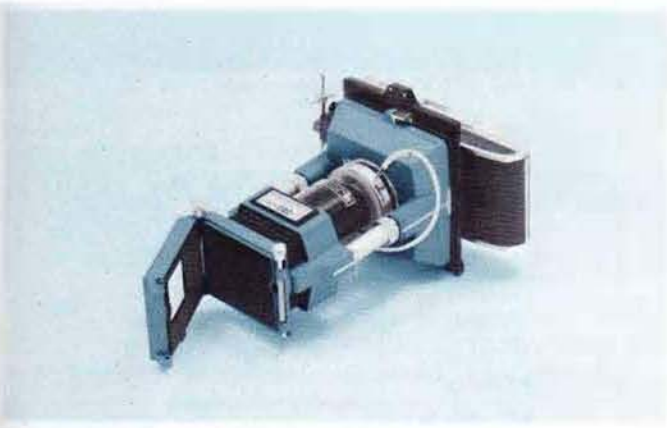

C-40 HIGH-SPEED CAMERA

f/1.3, 1:0.5 lens with Roll-Film back for 10,000 or 3000-speed film

TYPE **491** **R491**

10 MHz-to-40 GHz SPECTRUM ANALYZERS

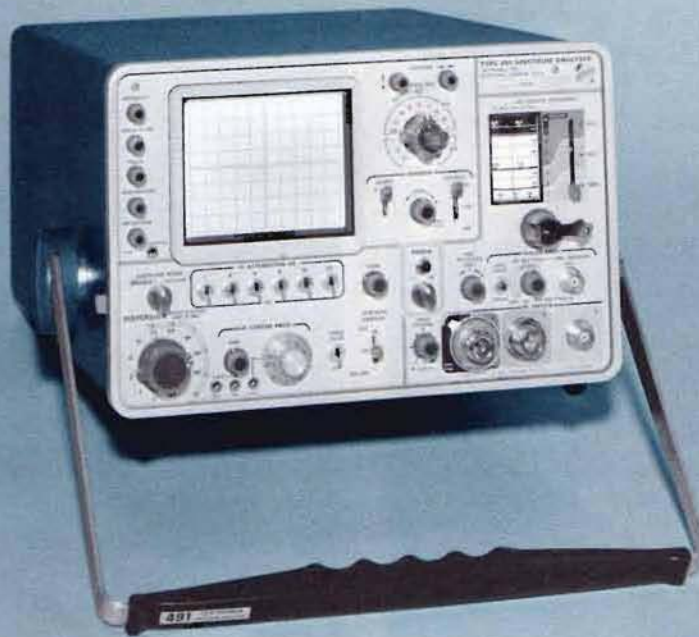

- **COMPACT, LIGHT WEIGHT**
- **INTERNAL PHASE LOCK**
- **CALIBRATED DISPERSION TO 100 MHz**
- **COUPLED RESOLUTION**
- **±1.5-dB DISPLAY FLATNESS TO 12.4 GHz**
- **WIDE-RANGE TIME BASE**
- **LOW POWER CONSUMPTION**
- **ENVIRONMENTALIZED**
- **SOLID-STATE DESIGN**

The Type 491 is a precision, wide-band spectrum analyzer designed for rugged environmental conditions and easy mobility. It is an easy-to-carry package weighing less than 40 pounds complete with accessories. The Type R491 is electrical-ly identical, requires only 7 inches of rack height.

Operation is simple. Resolution and calibrated dispersion controls are coupled, providing narrow resolution bandwidth at narrow dispersion and wide resolution bandwidth at wide dispersion. Since dispersion is calibrated, frequency differences can be read directly from the CRT. Internal phase lock provides stable displays even at 1 kHz/div dispersion.

Both Type 491 and R491 are completely self contained, have oscilloscope-type time base and trigger circuits, 8 x 10-div CRT with P7 phosphor and internal graticule. They operate over a wide range of AC voltages, require only 55 W, maximum.

BAND	FREQUENCY RANGE	MINIMUM CW SENSITIVITY*	
		1-kHz RESOLUTION	100-kHz RESOLUTION
1	10 MHz to 275 MHz	≥ -100 dBm	≥ -80 dBm
2	275 MHz to 900 MHz	≥ -110 dBm	≥ -90 dBm
3	800 MHz to 2000 MHz	≥ -105 dBm	≥ -85 dBm
4	1.5 GHz to 4.0 GHz	≥ -110 dBm	≥ -90 dBm
5	3.8 GHz to 8.2 GHz	≥ -100 dBm	≥ -80 dBm
6	8.2 GHz to 12.4 GHz	≥ -95 dBm	≥ -75 dBm
7	12.4 GHz to 18.0 GHz	≥ -90 dBm	≥ -70 dBm
8	18.0 GHz to 40 GHz	≥ -80 dBm to 26.5 GHz ≥ -70 dBm to 40 GHz	≥ -60 dBm ≥ -50 dBm

*Signal + noise = 2 X noise

DIAL ACCURACY

$\pm (2 \text{ MHz} + 1\% \text{ of dial reading})$.

CALIBRATED DISPERSION

1 kHz/div to 10 MHz/div in 1-2-5 sequence, 2 ranges (kHz/div — MHz/div). Accuracy throughout full range of IF-center frequency control, within $\pm 3\%$ except at 2 MHz/div ($\pm 5\%$) and 1 MHz/div ($\pm 7\%$). Accuracy can be increased using internal 1-MHz crystal markers for calibration. Dispersion linearity within $\pm 3\%$. Zero dispersion useful for PRF measurements.

COUPLED RESOLUTION

1 kHz to 100 kHz, coupled with calibrated dispersion positions but separately switchable.

DISPLAY FLATNESS

$\pm 1.5 \text{ dB}$ over $\pm 50\text{-MHz}$ dispersion, except over $\pm 25 \text{ MHz}$ for Band 1; $\pm 3 \text{ dB}$ over $\pm 50\text{-MHz}$ dispersion in waveguide Bands.

INCIDENTAL FM

Less than 300 Hz at fundamental, with Phase Lock.

FREQUENCY STABILITY

kHz/div dispersion range— $\pm 10 \text{ kHz}$ throughout line voltage range after 1 minute; $\pm 5 \text{ kHz}/^\circ\text{C}$. MHz/div dispersion range— $\pm 200 \text{ kHz}$ throughout line voltage range after 1 minute; $\pm 20 \text{ kHz}/^\circ\text{C}$.

PHASE LOCK

Internal 1-MHz reference. External input accepts 1-MHz to 5-MHz signals from 1 V to 5 V peak to peak.

INPUT IMPEDANCE

Approx 50Ω for coaxial inputs.

MAXIMUM INPUT POWER

-30 dBm for linear operation, $+15 \text{ dBm}$ (25 mW) safe diode power limit.

IF ATTENUATOR

51 dB in 1-dB steps, $\pm 0.1 \text{ dB/dB}$.

IF GAIN CONTROL

$> 50\text{-dB}$ range.

IF CENTER FREQUENCY

$\pm 25\text{-MHz}$ adjustment of center frequency from 5 MHz/div to 0.2 MHz/div dispersion positions, $\pm 10\text{-MHz}$ adjustment at 10 MHz/div, $\pm 2.5\text{-MHz}$ adjustment from 500 kHz/div to 1 kHz/div dispersion positions.

VERTICAL DISPLAY (8 DIVISIONS)

Log — $\geq 40\text{-dB}$ dynamic range.
Linear — $\geq 26\text{-dB}$ dynamic range.
Square Law — $\geq 13\text{-dB}$ dynamic range.

HORIZONTAL DEFLECTION

INTERNAL SAWTOOTH GENERATOR

$10 \mu\text{s/div}$ to 0.5 s/div in 15 calibrated steps (1-2-5 sequence). Uncalibrated continuously variable between steps and to approx 1.25 s/div .

TRIGGER SOURCE

Internal, external, or line. 100-V maximum external input (DC + peak AC).

TRIGGER REQUIREMENTS

0.2-div deflection or 0.2-V external from 20 Hz to 100 kHz.



CRT AND DISPLAY FEATURES

TEKTRONIX CRT

8 x 10-div display area (each div = 0.8 cm); P7 phosphor normally furnished.

GRATICULE

Internal, no parallax, variable edge lighting.

DISPLAY FEATURES

Intensity, focus and astigmatism controls. Intensifier adjusts relative brightness of signal and baseline for convenient viewing and photography.

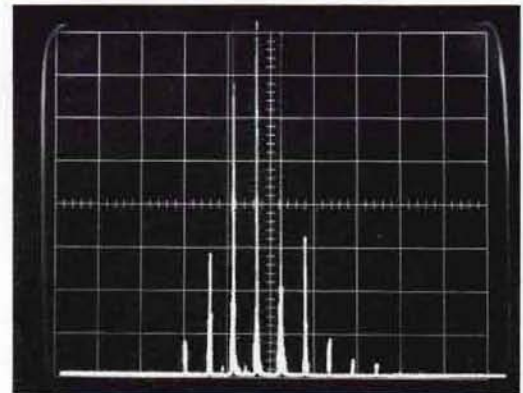

Quality of photographs is greatly enhanced when relative brightness of signal and baseline can be controlled, as in upper waveform. Lower waveform taken under same conditions shows normal results of slow sweep time/div settings. Improvement is even more pronounced in some applications. Waveforms photographed with C-30 Camera.

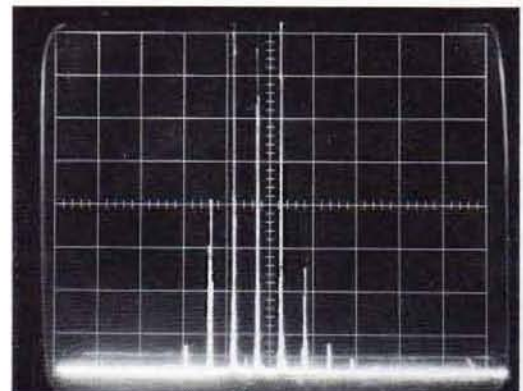

TYPE 491 R491



ENVIRONMENTAL CAPABILITIES

ELECTROMAGNETIC INTERFERENCE

Meets specifications of MIL-I-6181D over the following frequency ranges: Radiated (with CRT mesh filter installed) —150 kHz to 1 GHz; conducted (power line) —150 kHz to 25 MHz.

TEMPERATURE

Operating: —15° C to +55° C.
Non-operating: —55° C to +75° C.

ALTITUDE

Operating: 15,000 feet.
Non-operating: 50,000 feet.

HUMIDITY

Non-operating: Meets electrical performance specifications after exposure to five cycles (120 hours) of Mil-Std-202C, Method 106B (omit freezing and vibration, and allow a 24-hour post-test drying period at +25° C and 20% to 80% relative humidity).

VIBRATION

Operating: 15 minutes along each of the three axes, 0.025 inch peak to peak displacement (4 g's at 55 c/s) 10 to 55 to 10 c/s in 1-minute cycles.

SHOCK

Operating and non-operating: 30 g's, 1/2 sine, 11-ms duration, 1 shock per axis.

TRANSPORTATION

In shipping carton: Meets National Safe Transit test of vibration for 1 hour at slightly greater than 1 g, 30-inch drop (18-inch for R491) on any corner, edge, or flat surface of the shipping container.



OTHER CHARACTERISTICS

POWER REQUIREMENTS

90 to 136 VAC or 180 to 272 VAC, 48 to 440 Hz; 55 watts maximum. Rear panel selector provides rapid accommodation for six line-voltage ranges.

REAR PANEL CONNECTORS

BNC connectors for external trigger input, sawtooth output (70 to 90 mV P to P) and recorder output (≥ 4 mV/div of displayed signal in LIN mode, DC-coupled, approx 600- Ω source resistance).

CABINET MODEL DIMENSIONS AND WEIGHTS

Height	7 ³ / ₁₆ in	18.2 cm
Width	12 ⁷ / ₁₆ in	31.6 cm
Depth (incl. panel cover)	19 ¹ / ₁₆ in	50.0 cm
Depth (with handle extended)	21 ⁹ / ₁₆ in	54.7 cm
Net weight (w/o panel cover)	30 lb	13.6 kg
Weight (with panel cover and accessories)	38 lb	17.3 kg
Domestic shipping weight	≈50 lb	≈22.7 kg
Export-packed weight	≈62 lb	≈28.2 kg

RACK MODEL DIMENSIONS AND WEIGHTS

Height	7 in	17.8 cm
Width	19 in	48.3 cm
Rack depth	17 ¹ / ₂ in	44.4 cm
Net weight	41 lb	18.6 kg
Domestic shipping weight	≈72 lb	≈32.7 kg

RACK MOUNTING

Type R491 withdraws from rack on slide-out tracks, tilts for convenience. Further mounting information on catalog instrument dimension page.

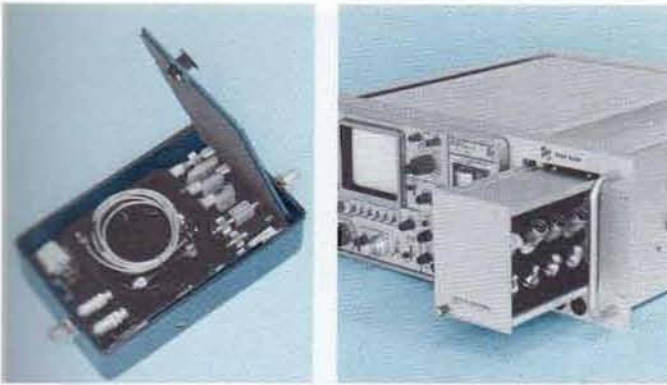

ACCESSORY STORAGE

Included panel dust cover for Type 491 and drawer for Type R491 hold all standard accessories except manuals and dust and rain cover.

INCLUDED STANDARD ACCESSORIES

6 ft BNC cable, 50 Ω miniature coax (012-0113-00); 6 ft N cable, RG 55/U coax (012-0114-00); 2 ft TNC cable, RG 55/U coax (012-0115-00); wave guide mixer, 12.4 to 18 GHz (119-0097-00); wave guide mixer, 18 to 26.5 GHz (119-0098-00); wave guide mixer, 26.5 to 40 GHz (119-0099-00); 10-dB attenuator, Type N fittings (011-0085-00); 20-dB attenuator, Type N fittings (011-0086-00); 40-dB attenuator, Type N fittings (011-0087-00); two BNC male to N female adapters (103-0058-00); two BNC female to N male adapters (103-0045-00); wave guide mixer adapter (119-0104-00); power cord (161-0024-01); dust and rain cover (016-0074-01); 3 to 2-wire adapter (103-0013-00); blue light filter (378-0558-00); amber light filter (378-0559-00); clear CRT protector plate (386-0118-00); ornamental guide mixer adapter (119-0104-00); power cord (161-0024-01); ring (354-0248-00); mesh filter, installed (378-0571-00); two one-ampere fuses (159-0022-00); 1/2-ampere fuse (159-0025-00); front cover (200-0633-03); two instruction manuals (070-0598-00). Type R491 includes all above accessories except the dust and rain cover, also includes mounting tracks and hardware.

CONVERSION KITS

PORTABLE TO RACK-MODEL

Kit includes hardware and instructions to convert existing Type 491 Analyzers for rack installations.

Order 040-0444-00

RACK MODEL TO PORTABLE

Kit includes cabinet and instructions to convert Type R491 Analyzers for portable operation.

Order 040-0445-00

OPTIONAL ACCESSORIES

Optional accessories provide added convenience to the Type 491 and R491. Cameras, Scope-Mobile® Carts and other major accessories are completely described in the catalog accessory pages.

COLLAPSIBLE VIEWING HOOD

Permits viewing of trace under high ambient-light conditions, order 016-0082-00

C-30 CAMERA

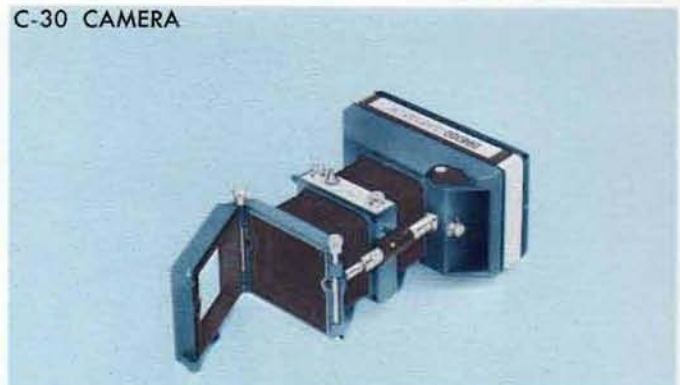

f/1.9 lens; magnification variable from 1.5:1 to 0.7:1; Polaroid Land* Pack-Film back

SCOPE-MOBILE® CART

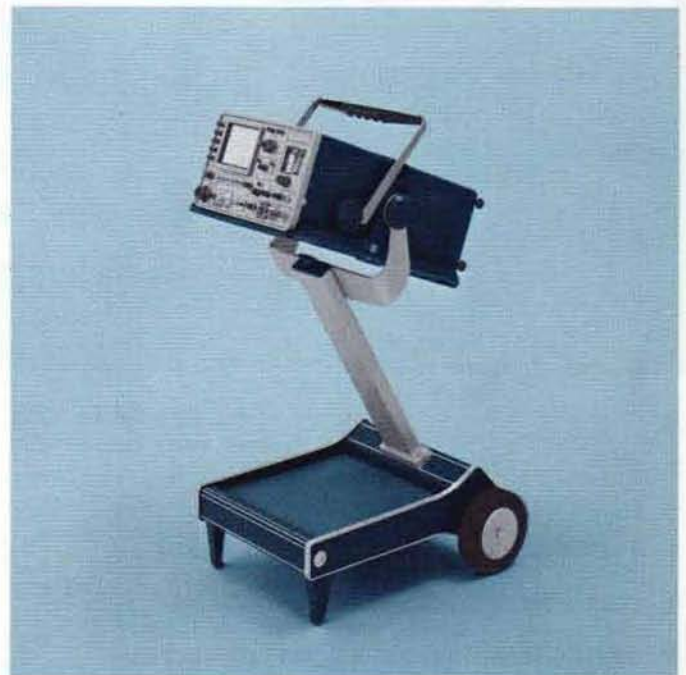

Model 200-1: friction locks hold Type 491 at 0° to 60° angle. Cart occupies <18 in of aisle space, goes up and down stairs easily, has storage space in base

PANEL DUST COVER

Included as a part of Type 491, protects front panel and holds standard accessories. Available separately for use with Type R491, order 200-0633-03

BNC THRU-PANEL ADAPTER

Mounts in pre-punched holes in Type R491 panel, BNC connector on both sides, order 103-0070-00

BNC CABLE

Used in conjunction with above adapter, provides access to rear-panel connectors on Type R491. BNC-to-BNC 3-foot cable, order 012-0117-00

*Registered Trade-Mark Polaroid Corporation

Please refer to Terms and Shipment, General Information page.

TYPE 502A RM502A

100 $\mu\text{V}/\text{cm}$ DUAL-BEAM OSCILLOSCOPE

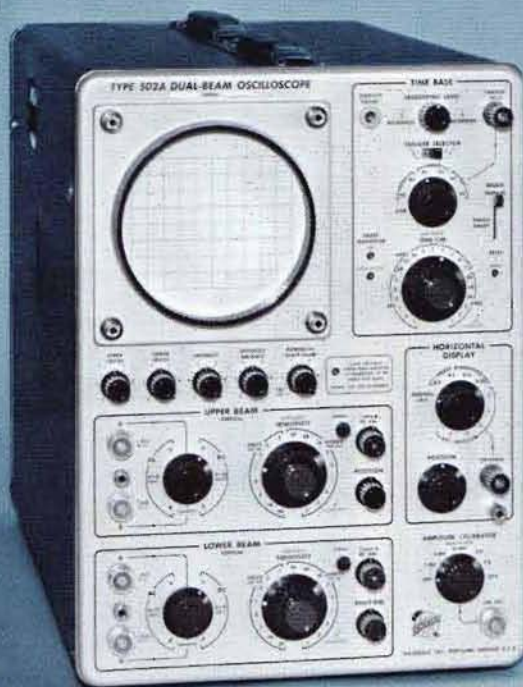

- 2 IDENTICAL VERTICAL AMPLIFIERS
- COMMON HORIZONTAL DEFLECTION
- DIFFERENTIAL INPUT AT ALL DEFLECTION FACTORS
- X-Y CURVE TRACING WITH 1 OR 2 BEAMS
- SINGLE SWEEP OPERATION
- BEAM FINDERS

A wide range of measurement capabilities make the Type 502A and RM502A useful in a variety of applications including education, biology, defense, and production control. Differential or single-ended inputs can be used for dual-beam or single-beam X-Y displays as well as dual-beam or single-beam time-based displays. With one of the vertical amplifiers switched to provide horizontal deflection, full sensitivity is available for both axes. Phase shift is less than 1 degree from DC to 100 kHz. With the external horizontal amplifier switched to provide horizontal deflection, dual-beam X-Y plots can be displayed at full vertical sensitivity, and at 0.1 V/cm to 2 V/cm horizontally.

CHARACTERISTIC SUMMARY

VERTICAL

BANDWIDTH—DC to 100 kHz at 100 $\mu\text{V}/\text{cm}$, increasing to DC to 1 MHz from 5 mV/cm to 20 V/cm.

CALIBRATED DEFLECTION FACTOR—100 $\mu\text{V}/\text{cm}$ to 20 V/cm.

INPUT RC—1 megohm paralleled by approx 47 pF.

COMMON-MODE REJECTION—At least 50,000:1 (DC to 50 kHz).

HORIZONTAL

CALIBRATED TIME BASE—1 $\mu\text{s}/\text{cm}$ to 5 s/cm.

SWEEP MAGNIFIER—X2, X5, X10, X20.

EXTERNAL INPUT—0.1, 0.2, 0.5, 1 and 2 V/cm.

CRT

DISPLAY AREA—8 x 10 cm (each beam).

ACCELERATING VOLTAGE—3 kV.

PHOSPHOR—P2.

OTHER

AMPLITUDE CALIBRATOR—0.5 mV to 50 V, 1-kHz square-wave.

POWER REQUIREMENTS—105 to 125 V or 210 to 250 V, 50 to 60 Hz; 290 watts.

APPLICATIONS

Here are just a few of the many possible uses for this versatile oscilloscope:

1. Compare and measure the waveforms at two points in a circuit simultaneously.
2. Display X-Y curves with one or both beams in a variety of applications.
3. Plot one transducer output against another—pressure against volume or temperature, for instance.
4. Use the differential-input feature for cancellation of common-mode signals, and to eliminate the need for a common terminal, in both single and dual displays.
5. Measure phase angles and frequency differences.

VERTICAL DEFLECTION

Two identical systems

BANDWIDTH

DC to ≥ 100 kHz (3-db down) at $100 \mu\text{V}/\text{cm}$, increasing to DC to ≥ 1 MHz (3-db down) from $5 \text{ mV}/\text{cm}$ to $20 \text{ V}/\text{cm}$. Low-frequency 3-db-down point is ≤ 2 Hz with AC coupling, ≤ 0.2 Hz with included 10X probe.

DEFLECTION FACTOR

$100 \mu\text{V}/\text{cm}$ to $20 \text{ V}/\text{cm}$ in 17 calibrated steps (1-2-5 sequence), accurate within 2% (3% at $100 \mu\text{V}/\text{cm}$). Uncalibrated, continuously variable between steps and to approx $50 \text{ V}/\text{cm}$.

INPUT RC

1 megohm paralleled by approx 47 pF.

MAXIMUM INPUT VOLTAGE (DC to 1 MHz)

50 V (combined DC + peak AC) from $100 \mu\text{V}/\text{cm}$ to $0.2 \text{ V}/\text{cm}$. 350 V (combined DC + peak AC) from $0.5 \text{ V}/\text{cm}$ to $20 \text{ V}/\text{cm}$.

COMMON-MODE DYNAMIC RANGE

$100 \mu\text{V}/\text{cm}$ to $0.2 \text{ V}/\text{cm}$ — $\pm 15 \text{ V}$.
 $0.5 \text{ V}/\text{cm}$ to $20 \text{ V}/\text{cm}$ — $\pm 350 \text{ V}$.

COMMON-MODE REJECTION

$\geq 50,000:1$ from $100 \mu\text{V}/\text{cm}$ to $2 \text{ mV}/\text{cm}$ (DC to 50 kHz), $\geq 1000:1$ at $200 \text{ mV}/\text{cm}$ (DC to 50 kHz) with $\pm 5 \text{ V}$ input; adjustable to $\geq 5000:1$ (DC to 1 kHz) and to $\geq 500:1$ (to 50 kHz) from $0.5 \text{ V}/\text{cm}$ to $20 \text{ V}/\text{cm}$ with $\pm 50 \text{ V}$ input. $\geq 2000:1$ at 60 Hz with AC coupling.

DC DRIFT

Typically $\leq 400 \mu\text{V}/\text{hour}$ averaged over 10 hours, temperature and line voltage constant. $\leq 300 \mu\text{V}$ with line variation from 105 to 125 V AC.

DIRECT-COUPLED SIGNAL OUTPUTS

CF outputs for each amplifier at rear panel. Approx 2 V for each centimeter of displayed signal.

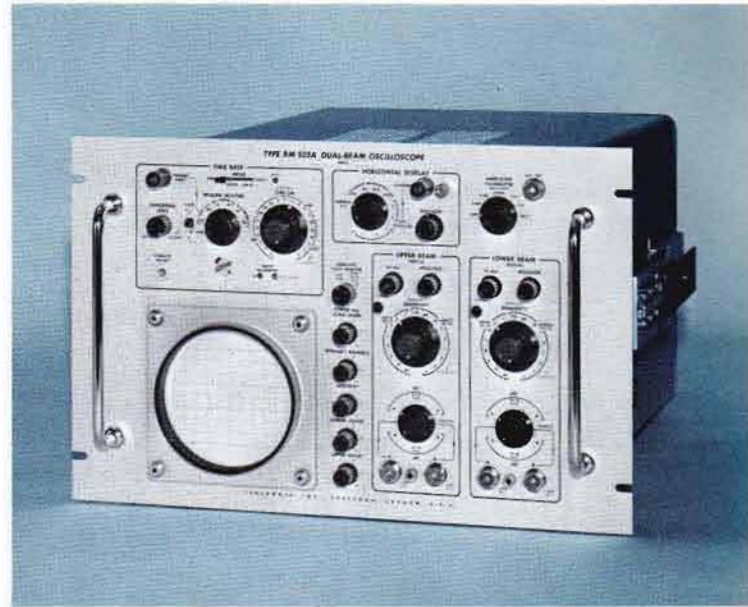

HORIZONTAL DEFLECTION

Common to both beams

TIME BASE

$1 \mu\text{s}/\text{cm}$ to $5 \text{ s}/\text{cm}$ in 21 calibrated steps (1-2-5 sequence), accurate within 3%. Uncalibrated, continuously variable between steps and to approx $12.5 \text{ s}/\text{cm}$. Warning light indicates uncalibrated setting.

SWEEP MAGNIFIER

X2, X5, X10, or X20 magnification; magnified time base accurate within 5% up to $1 \mu\text{s}/\text{cm}$.

DISPLAY MODES

Normal or single sweep.

EXTERNAL INPUT

$0.1 \text{ V}/\text{cm}$ to $2 \text{ V}/\text{cm}$ in 5 calibrated steps (1-2-5 sequence), accuracy within $\pm 5\%$, DC to 100 kHz. 20 V maximum (DC + peak AC). Input RC approx 1 megohm paralleled by approx 70 pF.

X-Y OPERATION

SINGLE-BEAM CURVE TRACING

$100 \mu\text{V}/\text{cm}$ to $20 \text{ V}/\text{cm}$ calibrated deflection factor in each axis, differential or single-ended input. Panel light indicates upper beam amplifier switched to provide horizontal deflection. X-Y phase difference between amplifiers is $\leq 1^\circ$ from DC to 100 kHz, measured at $100 \mu\text{V}/\text{cm}$.

DUAL-BEAM CURVE TRACING

$100 \mu\text{V}/\text{cm}$ to $20 \text{ V}/\text{cm}$ calibrated vertical deflection factor, separately selectable for upper and lower beams, differential or single-ended input; $0.1 \text{ V}/\text{cm}$ to $2 \text{ V}/\text{cm}$ calibrated horizontal deflection factor using external horizontal input common to both beams.

TRIGGER

MODES

Automatic or manual level selection, free run (recurrent). Automatic operation minimizes trigger adjustment for signals of different amplitudes, shapes, and repetition rates. With no input, automatic triggering occurs at an approx 50-Hz rate, providing a convenient reference trace.

TYPE 502A RM502A

COUPLING

AC or DC.

SOURCES

Internal from either amplifier, external, or line. Input R approx 1 megohm.

REQUIREMENTS

2-mm deflection throughout instrument bandwidth, 0.5 to 10 V external from DC to 1 MHz. Requirements increase below 50 Hz with AC coupling.

CRT AND DISPLAY FEATURES

TEKTRONIX DUAL-BEAM CRT

8 x 10-cm display per beam with 6-cm overlap. Separate vertical-deflection plates; common horizontal deflection plates. 3-kV accelerating potential. P2 phosphor normally supplied. Z-axis input requires ± 25 V peak to peak for beam modulation at normal intensity.

GRATICULE

External; variable edge lighting. 10 x 10-cm display area. Vertical and horizontal centerlines marked in 2-mm divisions.

DISPLAY FEATURES

Pushbutton beam finder for each beam, separate focus for each beam, common intensity, intensity balance.

OTHER CHARACTERISTICS

AMPLITUDE CALIBRATOR

0.5 mV to 50 V in 6 calibrated decade steps, accurate within 3%. 1-kHz $\pm 30\%$ repetition rate.

POWER REQUIREMENT

Wired for 105 to 125 VAC (117-V nominal). Transformer taps permit operation at nominal voltages of 110, 117, 124, 220, 234 and 248 VAC, 50 to 60 Hz. Power consumption 290-W maximum.

CABINET MODEL DIMENSIONS AND WEIGHTS

Height	15 $\frac{7}{8}$ in	40.3 cm
Width	11 $\frac{3}{8}$ in	28.9 cm
Depth	23 $\frac{7}{8}$ in	60.7 cm
Net weight	50 $\frac{1}{4}$ lb	22.8 kg
Domestic shipping weight	≈ 62 lb	≈ 28.2 kg
Export-packed weight	≈ 84 lb	≈ 38.2 kg

RACK MODEL DIMENSIONS AND WEIGHTS

Height	12 $\frac{1}{4}$ in	31.1 cm
Width	19 in	48.3 cm
Rack depth	22 $\frac{3}{4}$ in	57.8 cm
Net weight	58 lb	26.4 kg
Domestic shipping weight	≈ 97 lb	≈ 44.1 kg
Export-packed weight	≈ 117 lb	≈ 53.2 kg

Type RM502A can be withdrawn from rack on slide-out tracks, tilted and locked in 4 positions.

INCLUDED STANDARD ACCESSORIES

Two P6006 10X probes (010-0125-00), test lead (012-0031-00), two binding-post adapters (013-0004-00), 3 to 2-wire adapter (103-0013-00), 3-conductor power cord (161-0010-03), smoke-gray light filter (378-0567-00), two instruction manuals (070-0382-02). Type RM502A includes in addition one pair mounting tracks (351-0085-00), and mounting hardware.

OPTIONAL ACCESSORIES

Optional accessories increase measurement capability and provide added convenience. The standard 10X probes supplied with the oscilloscope, and the listed optional probes satisfy most measurement requirements. Other probes are available for current and high-voltage measurements. See catalog accessory pages for additional information on these and other items.

SCOPE-MOBILE® CART

Model 202-1: storage drawer and 9-position tilt-lock oscilloscope tray

Order tray adapter 040-0365-00

CAMERAS

C-27-547: f/1.9—1:0.7 lens, Polaroid Land¹ Pack Film back provides 10 x 10-cm coverage on 3 $\frac{1}{4}$ x 4 $\frac{1}{2}$ film.

C-27G: f/1.9—1:0.85 lens, no back, provides 10 x 10-cm coverage on 4 x 5 film with optional Graflok² back and Polaroid Land film holder

Graflok back for 4 x 5 film holder (not included).

Order 122-0604-00

Type 502A to C-27-547 or C-27G Camera adapter, order 016-0225-00

PROBES

P6023 10X Probe: for more-accurate differential measurements, order 010-0065-00

P6027 1X Probe: 1-M Ω , ≈ 90 pF input RC, order 010-0070-00

¹ Registered Trade-Mark Polaroid Corporation

² Registered Trade-Mark Graflex, Inc.

Please refer to Terms and Shipment, General Information page.

DC-to-450 kHz X-Y OSCILLOSCOPES

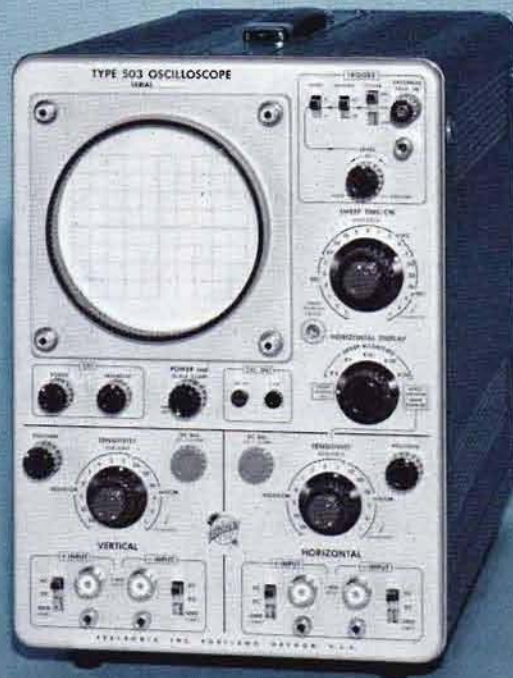

- **IDENTICAL VERTICAL & HORIZONTAL AMPLIFIERS**
- **DIFFERENTIAL INPUT AT ALL DEFLECTION FACTORS**
- **ELECTRONICALLY-REGULATED DC SUPPLIES**
- **COMPACT CABINET OR RACK MODELS**

The Type 503 and RM503 provide accurate measurements and signal-handling versatility in DC-to-450 kHz applications. Differential or single-ended inputs can be used for X-Y displays or conventional time-based displays. Large display area, simple operation, and low cost make the Type 503 ideal for classroom and production-line uses.

The Type RM503, for the same reasons, is ideal for inclusion in a variety of systems, or other monitor applications.

CHARACTERISTIC SUMMARY

VERTICAL & HORIZONTAL

BANDWIDTH—DC to 450 kHz.

CALIBRATED DEFLECTION FACTOR—1 mV/cm to 20 V/cm.

INPUT RC—1 megohm paralleled by approx 47 pF.

COMMON-MODE REJECTION—100:1 at 1 mV/cm deflection factor. DC to 50 kHz, 4 V P to P, max.

SWEEP GENERATOR

CALIBRATED TIME BASE—1 μ s/cm to 5 s/cm.

SWEEP MAGNIFIER—X2, X5, X10, X20, X50.

CRT

DISPLAY AREA—8 x 10 cm.

ACCELERATING VOLTAGE—3 kV.

PHOSPHOR—P2.

OTHER

AMPLITUDE CALIBRATOR—5 mV and 0.5 V, approx 350 Hz squarewave.

POWER REQUIREMENTS—105 to 125 V or 210 to 250 V, 120 watts, max.

TYPE 503 RM503

VERTICAL AND HORIZONTAL DEFLECTION

Two identical systems

BANDWIDTH

DC to 450 kHz at 3-dB down. Low-frequency 3-dB point is ≤ 10 Hz with AC coupling. Bandwidth constant at all deflection factors.

DEFLECTION FACTOR

1 mV/cm to 20 V/cm in 14 calibrated steps (1-2-5 sequence), accurate within 3%. Uncalibrated, continuously variable between steps and to at least 50 V/cm.

INPUT RC

1 megohm paralleled by approx 47 pF.

MAXIMUM INPUT VOLTAGE

350 V combined DC + peak AC.

COMMON-MODE REJECTION

From DC to 50 kHz: $\geq 100:1$ at calibrated deflection factors from 1 mV/cm to 0.2 V/cm with 4-V peak to peak input, $\leq 30:1$ at calibrated deflection factors from 0.5 V/cm to 20 V/cm with 40-V peak to peak input (400-V peak to peak from 5 V/cm to 20 V/cm).

PHASE DIFFERENCE IN X-Y MODE

$\leq 1^\circ$ to 450 kHz at equal calibrated deflection factors from 1 mV/cm to 0.2 V/cm, $\leq 2^\circ$ to 50 kHz at equal calibrated deflection factors from 0.5 V/cm to 20 V/cm. Same polarity inputs in both cases.

HORIZONTAL DEFLECTION

TIME BASE

1 μ s/cm to 5 s/cm in 21 calibrated steps (1-2-5 sequence) accurate within 3%. Uncalibrated, continuously variable between steps and to at least 12 s/cm.

MAGNIFIER

X2, X5, X10, X20 or X50 magnification; magnified time base accurate within 5% up to 0.1 μ s/cm.

TRIGGER

MODES

Automatic or manual level selection, free run. Automatic operation is useful from 50 Hz to 450 kHz, minimizes trigger adjustment for signals of different amplitudes, shapes, and repetition rates. With no input, automatic triggering occurs at an approx 50-Hz rate, providing a convenient reference trace.

COUPLING

AC or DC.

SOURCES

Internal, external or line.

REQUIREMENTS

$\frac{1}{2}$ -cm deflection from DC to 50 kHz, increasing to 2-cm deflection at 450 kHz; $\frac{1}{2}$ V external from DC to 450 kHz. Requirements increase below 50 Hz with AC coupling. Automatic operation requires 4/5-cm deflection from 50 Hz to 50 kHz, increasing to 2.5 cm at 450 kHz; $\frac{1}{2}$ V external from 50 Hz to 450 kHz.

CRT

TEKTRONIX CRT

3-kV accelerating potential. P2 phosphor normally supplied. Z-axis input requires ± 10 V for CRT modulation at normal intensity.



GRATICULE

External; variable edge lighting. 8 x 10-cm display area. Vertical and horizontal centerlines marked in 2-mm divisions.

OTHER CHARACTERISTICS

AMPLITUDE CALIBRATOR

5-mV and 500-mV squarewaves, accurate within 3%. 350-Hz $\pm 50\%$ repetition rate.

POWER REQUIREMENTS

Wired for 105 to 125 VAC (117-V nominal); transformer taps permit operation from 210 to 250 VAC (234-V nominal); 50 to 60 Hz. Operates from 112 to 132 or 224 to 264 VAC at 400 Hz, 120 to 140 or 240 to 280 VAC at 800 Hz. 120-W maximum power consumption (125 V at 50 Hz).

CABINET MODEL DIMENSIONS AND WEIGHTS

Height	14 $\frac{11}{16}$ in	37.3 cm
Width	9 $\frac{3}{4}$ in	24.8 cm
Depth	21 $\frac{5}{8}$ in	55.0 cm
Net weight	29 $\frac{1}{2}$ lb	13.4 kg
Domestic shipping weight	≈ 38 lb	≈ 17.3 kg
Export-packed weight	≈ 51 lb	≈ 23.2 kg

RACK MODEL DIMENSIONS AND WEIGHTS

Height	7 in	17.8 cm
Width	19 in	48.3 cm
Rack depth	17 in	43.2 cm
Net weight	28 lb	12.7 kg
Domestic shipping weight	≈ 51 lb	≈ 23.2 kg
Export-packed weight	≈ 72 lb	≈ 32.7 kg

RACK MOUNTING

Type RM503 mounts directly to standard 19-inch rack. MOD 171A provides slide-out tracks. Instrument can be conveniently withdrawn, tilted and locked in 7 positions.

INCLUDED STANDARD ACCESSORIES

Two A510 binding-post adapters (013-0004-00); 3 to 2-wire adapter (103-0013-00); smoke-gray filter (378-0567-00); two instruction manuals (070-0218-01). Type RM503 also includes mounting hardware; 3-conductor power cord (161-0024-01); two instruction manuals (070-0314-00).

DC-to-450 kHz OSCILLOSCOPES

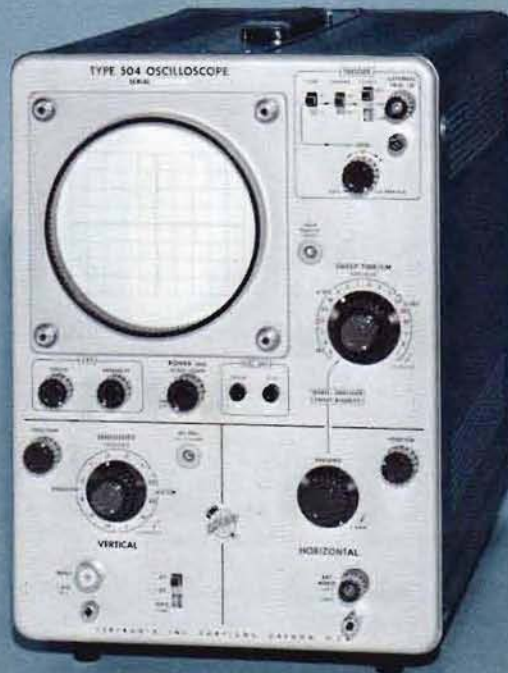

CHARACTERISTIC SUMMARY

VERTICAL

BANDWIDTH—DC to 450 kHz.

CALIBRATED DEFLECTION FACTOR—5 mV/cm to 20 V/cm.

INPUT RC—1 megohm paralleled by approx 47 pF.

HORIZONTAL

CALIBRATED TIME BASE—1 μ s/cm to 0.5 s/cm.

EXTERNAL INPUT—0.5 V/cm, variable.

CRT

DISPLAY AREA—8 x 10 cm.

ACCELERATING VOLTAGE—3 kV.

PHOSPHOR—P2.

OTHER

AMPLITUDE CALIBRATOR—25 mV and 0.5 V, approx 350 Hz squarewave.

POWER REQUIREMENTS—105 to 125 V or 210 to 250 V, 115 watts, max.

- **ELECTRONICALLY-REGULATED DC SUPPLIES**

- **COMPACT CABINET OR RACK MODELS**

The Type 504 and RM504 provide accurate measurements in DC-to-450 kHz applications. Features include easy-to-use triggering, 1-2-5 sequence on Vertical Sensitivity and Horizontal Time/cm switches, and Calibrator outputs. Large display area, simple operation, and low cost make the Type 504 ideal for classroom and production-line uses.

The Type RM504, for the same reasons, is ideal for inclusion in a variety of systems, or other monitor applications.

504

RM504

VERTICAL DEFLECTION

BANDWIDTH

DC to 450 kHz at 3-dB down. Low-frequency 3-dB point is ≤ 10 Hz with AC coupling. Bandwidth constant at all deflection factors.

DEFLECTION FACTOR

5 mV/cm to 20 V/cm in 12 calibrated steps (1-2-5 sequence), accurate within 3%. Uncalibrated, continuously variable between steps and to at least 50 V/cm.

INPUT RC

1 megohm paralleled by approx 47 pF.

MAXIMUM INPUT VOLTAGE

350 V combined DC + peak AC.

HORIZONTAL DEFLECTION

TIME BASE

1 μ s/cm to 0.5 s/cm in 18 calibrated steps (1-2-5 sequence) accurate within 3%. Uncalibrated, continuously variable between steps and to at least 1.2 s/cm.

EXTERNAL INPUT

0.5 V/cm, variable.

TRIGGER

MODES

Automatic or manual level selection, free run. Automatic operation is useful from 50 Hz to 450 kHz, minimizes trigger adjustment for signals of different amplitudes, shapes, and repetition rates. With no input, automatic triggering occurs at an approx 50-Hz rate, providing a convenient reference trace.

COUPLING

AC or DC.

SOURCES

Internal, external or line.

REQUIREMENTS

$\frac{1}{2}$ -cm deflection from DC to 50 kHz, increasing to 2-cm deflection at 450 kHz; $\frac{1}{2}$ V external from DC to 450 kHz. Requirements increase below 50 Hz with AC-coupling. Automatic operation requires $\frac{4}{5}$ -cm deflection from 50 Hz to 50 kHz, increasing to 2.5 cm at 450 kHz; $\frac{1}{2}$ V external from 50 Hz to 450 kHz.

CRT

TEKTRONIX CRT

3-kV accelerating potential. P2 phosphor normally supplied. Z-axis input requires ± 10 V for beam modulation at normal intensity.

GRATICULE

External; variable edge lighting. 8 x 10-cm display area. Vertical and horizontal centerlines marked in 2-mm divisions.

OTHER CHARACTERISTICS

AMPLITUDE CALIBRATOR

25-mV and 500-mV squarewaves, accurate within 3%. 350 Hz $\pm 50\%$ repetition rate.

POWER REQUIREMENTS

Wired for 105 to 125 VAC (117-V nominal); transformer taps permit operation from 210 to 250 VAC (234-V nominal); 50 to 60 Hz. Operates from 112 to 132 or 224 to 264 VAC at 400 Hz, 120 to 140 or 240 to 280 VAC at 800 Hz. 115-W maximum power consumption (125 V at 50 Hz).

CABINET MODEL DIMENSIONS AND WEIGHTS

Height	14 $\frac{1}{16}$ in	37.3 cm
Width	9 $\frac{3}{4}$ in	24.8 cm
Depth	21 $\frac{5}{8}$ in	55.0 cm
Net weight	27 $\frac{1}{2}$ lb	12.5 kg

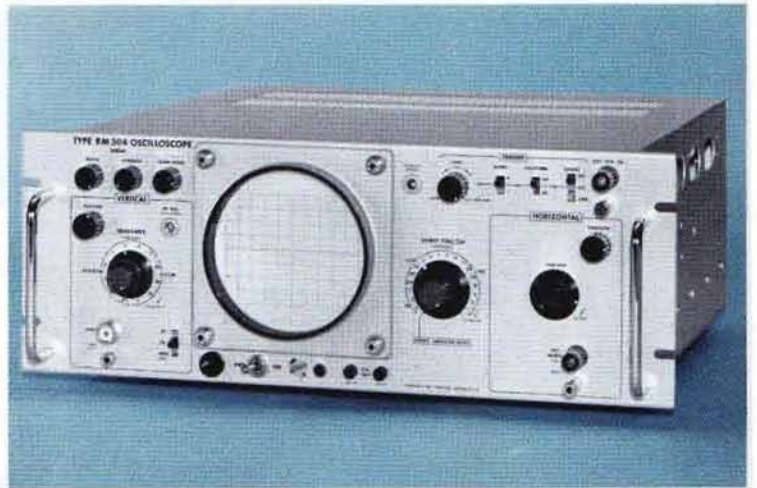

Domestic shipping weight	≈ 36 lb	≈ 16.4 kg
Export-packed weight	≈ 50 lb	≈ 22.7 kg

RACK MODEL DIMENSIONS AND WEIGHTS

Height	7 in	17.8 cm
Width	19 in	48.3 cm
Rack depth	17 in	43.2 cm
Net weight	25 $\frac{1}{2}$ lb	11.6 kg
Domestic shipping weight	≈ 49 lb	≈ 22.3 kg
Export-packed weight	≈ 69 lb	≈ 31.4 kg

RACK MOUNTING

Type RM504 mounts directly to standard 19 inch rack. MOD 171A can be withdrawn from rack on slide-out tracks, tilted and locked in 7 positions.

INCLUDED STANDARD ACCESSORIES

A510 binding-post adapter (013-0004-00); 3 to 2-wire adapter (103-0013-00); smoke-gray filter (378-0567-00); two instruction manuals (070-0224-00). Type RM504 also includes mounting hardware; 3-conductor power cord (161-0024-01); two instruction manuals (070-0313-00).

OPTIONAL ACCESSORIES

PROBES

P6006 10X Probe Package, order 010-0125-00
 P6007 100X Probe Package, order 010-0134-00
 P6027 1X Probe Package, order 010-0070-00

SCOPE-MOBILE® CART

Model 201-1: storage drawer and 9-position tilt-lock oscilloscope tray

SLIDE-OUT TRACKS

Convert standard Type RM504 to MOD 171A, provide easy withdrawal and tilt of instrument, order 351-0050-00

CAMERAS

Standard C-12 provides no-parallax viewing, f/1.9-1:0.85 lens, Polaroid Land* Pack Film back

Type 504 or RM504 to C-12 Camera adapter.

Order 016-0226-00

Standard C-27 has rotating and removable viewing hood allowing mounting on adjacent Type RM504's, f/1.9-1:0.85 lens. Polaroid Land Pack Film back

Type 504 or RM504 to C-27 Camera adapter.

Order 016-0225-00

*Registered Trade-Mark Polaroid Corporation

Please refer to Terms and Shipment, General Information page.

DC-to-15 MHz OSCILLOSCOPES



- **50-mV/CM DEFLECTION FACTOR**
- **INTERNAL DELAY LINE**
- **TWO INPUTS, SELECTABLE FROM THE FRONT PANEL**
- **AMPLITUDE CALIBRATOR**

The Tektronix Type 515A is a DC-coupled general purpose cathode-ray oscilloscope combining reliable circuitry in an easy-to-use, compact instrument. Wide time-base range, broad bandwidth characteristics, and calibrated deflection factor make the Type 515A well suited for general-purpose laboratory work and production-line testing applications.

CHARACTERISTIC SUMMARY

VERTICAL

BANDWIDTH—DC to 15 MHz.

RISETIME—23 ns.

CALIBRATED DEFLECTION FACTOR—50 mV/cm to 20 V/cm.

INPUT RC—1 megohm paralleled by approx 36 pF.

HORIZONTAL

CALIBRATED TIME BASE—0.2 μ s/cm to 2 s/cm.

X5 MAGNIFIER—Operates over full time base, increases fastest rate to 40 ns/cm.

EXTERNAL INPUT—1.4 V/cm to approx 25 V/cm. DC to 500 kHz at 1.4 V/cm.

CRT

DISPLAY AREA—6 x 10 cm.

ACCELERATING VOLTAGE—4 kV.

PHOSPHOR—P31.

OTHER

AMPLITUDE CALIBRATOR—50 mV to 100 V, approx 1-kHz squarewave.

POWER REQUIREMENTS—105 to 125 V or 210 to 250 V, 50 to 60 Hz, approx 300 W.

TYPE **515A** **RM15**

VERTICAL DEFLECTION

BANDWIDTH

DC to 15 MHz at 3-dB down. Low-frequency 3-dB-down point is approx 2 Hz with AC coupling, approx 0.2 Hz with included 10X probe.

RISETIME

23 ns.

DEFLECTION FACTOR

50 mV/cm to 20 V/cm in 9 calibrated steps, 1-2-5 sequence. All steps accurate within 3%. Uncalibrated, continuously variable between steps and to approx 50 V/cm. Warning light indicates uncalibrated setting.

INPUT RC

1 megohm paralleled by approx 36 pF.

MAXIMUM INPUT VOLTAGE

600 V combined DC and peak AC.

SIGNAL INPUTS

Two manually-selected signal inputs with approx 60-dB isolation.

DELAY LINE

Permits viewing of leading edge of triggering waveform.

HORIZONTAL DEFLECTION

TIME BASE

0.2 μ s/cm to 2 s/cm in 22 calibrated steps (1-2-5 sequence), accurate within 3%. Uncalibrated, continuously variable between steps and to approx 5 s/cm. Warning light indicates uncalibrated setting.

X5 MAGNIFIER

Operates over full time base, increases fastest rate to 40 ns/cm. Accuracy of magnified time base is within 5%. A neon light indicates when the magnifier is in use.

EXTERNAL INPUT

Variable between approx 1.4 V/cm to 25 V/cm. DC to 500 kHz at 1.4 V/cm (3-dB-down).

OTHER

Gate output: positive-going rectangular pulse with same duration as time base; approx 20-V amplitude.

Sawtooth output: positive-going ramp with same duration as time base; approx 150-V amplitude.

TRIGGER

MODES

Manual level selection; Automatic; Preset Stability; HF SYNC. Automatic triggering may be used for signal repetition rates between approx 50 Hz to 2 MHz, eliminating the need for re-adjusting TRIGGERING LEVEL while sequentially viewing signals of different amplitudes, shapes, and repetition rates. With no input, automatic triggering occurs at an approx 50-Hz rate, providing a convenient reference trace. HF SYNC assures a steady display of sinewave signals up to approx 20 MHz.

COUPLING

DC or AC.

SOURCES

Internal; External; or Line.

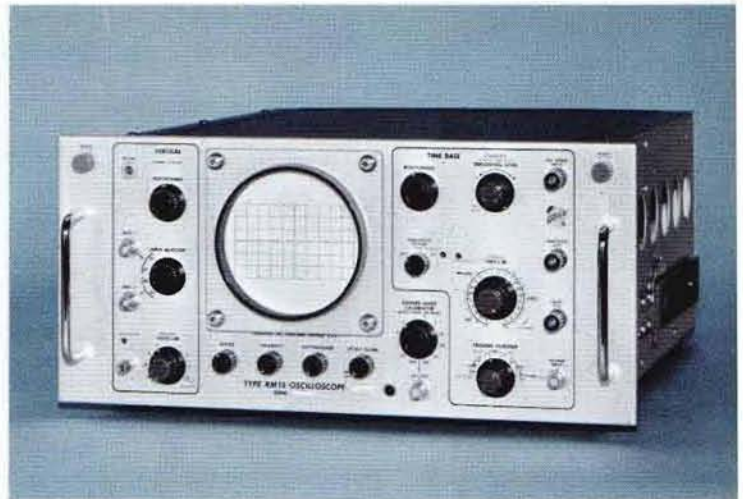

REQUIREMENTS

AC coupling requires 2-mm deflection (internal) or 0.5 V external at 1 kHz, increasing to 5-mm deflection or 1.5 V external at 2 MHz; low-frequency response is 3-dB down at approximately 16 Hz. DC coupling requires 5-mm deflection (internal) or 0.5 V external from DC to 1 kHz, increasing to 2-cm deflection or 1.5 V external at 2 MHz. Automatic triggering requires 5-mm deflection (internal) or 1 V external from 50 Hz to 1 kHz, increasing to 1-cm deflection or 3 V external at 2 MHz. HF sync requires 2-cm deflection or 2 V external at 20 MHz.

OTHER CHARACTERISTICS

AMPLITUDE CALIBRATOR

Approx 1-kHz squarewave; 50 mV to 100 V peak to peak in 11 steps (1-2-5 sequence); accurate within 3%.

TEKTRONIX CRT

Round, 5-inch, flat-faced tube with helical post-accelerating anode. 4-kV accelerating potential. Edge-lighted graticule is scaled with 6 vertical and 10 horizontal centimeter divisions. P31 phosphor normally supplied. Z-axis input (515A only): AC-coupled to CRT cathode; 15 nF, 27 k Ω . Positive signal of 5 V will provide adequate blanking of trace at moderate intensity setting. Maximum recommended drive is ± 20 V.

DIMENSIONS AND WEIGHTS

Height	14 $\frac{1}{16}$ in	35.7 cm
Width	9 $\frac{3}{4}$ in	24.8 cm
Depth	21 $\frac{13}{16}$ in	55.4 cm
Net weight	42 lb	19.1 kg
Domestic shipping weight	\approx 51 lb	\approx 23.2 kg
Export-packed weight	\approx 64 lb	\approx 29 kg

POWER REQUIREMENTS

105 V to 125 V or 210 V to 250 V, 50 to 60 Hz, wired for 117 V center. Instrument can be ordered wired for operation on any line voltage listed below. Power consumption is approx 300 watts.

Changing taps insures regulation as follows:

110	99 to 117 volts	220	198 to 235 volts
117	105 to 125 volts	234	210 to 250 volts
124	111 to 132 volts	248	223 to 265 volts

INCLUDED STANDARD ACCESSORIES

P6006 10X probe package (010-0127-00); 3 to 2-wire adapter (103-0013-00); 3-conductor power cord (161-0010-03); smoke gray filter (378-0567-00); patch cord, BNC-to-BNC, 18 inch (012-0087-00); patch cord, BNC-to-banana plug, 18 inch (012-0091-00); post jack, BNC (012-0092-00); two instruction manuals (070-0247-00).

RACK-MOUNT OSCILLOSCOPE

The Type RM15 is a mechanically rearranged Type 515A Oscilloscope. It mounts in a standard 19-inch rack on slide-out tracks. It can be pulled forward, tilted, and locked in any of seven positions for servicing convenience. Except for no Z-axis input, electrical characteristics of Type RM15 are the same as described for Type 515A Oscilloscope.

DIMENSIONS AND WEIGHTS

Height	8 ³ / ₄ in	22.2 cm
Width	19 in	48.2 cm
Depth	22 ¹ / ₁₆ in	57.8 cm
Net weight	42 lb	19.1 kg
Domestic shipping weight	≈76 lb	≈34.6 kg
Export-packed weight	≈96 lb	≈43.6 kg

INCLUDED STANDARD ACCESSORIES

Type RM15 includes accessories listed for Type 515A plus one pair mounting tracks (351-0085-00). Part number for included instruction manuals is (2) (070-0242-00).

OPTIONAL ACCESSORIES

Optional accessories serve to extend the usefulness of the Type 515A and Type RM15 in certain applications. This listing covers only the more commonly used items. The standard probe (10X) supplied with the instrument satisfies most measurement requirements; optional probes may be better suited for particular applications. In addition to the listed optional probes, other probes are available for current and high-voltage measurements. A complete list of accessory items can be found in the catalog accessory pages.

SUPPORTING CRADLES

When the Type RM15 is used in a backless rack, these supporting cradles are necessary for rear slide support.
Order 040-0344-00

SCOPE-MOBILE® CART

Type 201-1 Scope-Mobile® Cart features tilt locking in any of nine positions for convenience in viewing Type 515A. 5-inch rubber wheels permit easy transport between locations.

DUST COVER

Provides protection for Type 515A during transport or storage. Made of waterproof blue vinyl with a clear frontal area for easy identification of the instrument.
Order 016-0067-00

POLARIZED VIEWER

The polarized viewer reduces troublesome reflections and glare under high ambient-light conditions. Order 016-0053-00

VIEWING HOOD

Includes molded rubber eyepiece and separate tubular light shield. Order 016-0001-01

CAMERAS

Standard C-12 provides no-parallax viewing, f/1.9-1:0.85 lens, Polaroid Land* Pack Film back

Type 515 or RM15 to C-12 Camera adapter.
Order 016-0226-00

Standard C-27 has rotating and removable viewing hood allowing mounting on adjacent Type RM15's, f/1.9-1:0.85 lens, Polaroid Land Pack Film back

Type 515 or RM15 to C-27 Camera adapter.
Order 016-0225-00

PROBES

P6007 100X Probe Package, order 010-0150-00

P6028 1X Probe Package, order 010-0074-00

*Registered Trade-Mark, Polaroid Corporation.

Please refer to Terms and Shipment, General Information page.

TYPE 516

DC-to-15 MHz DUAL-TRACE OSCILLOSCOPE



- 50-mV/cm DEFLECTION FACTOR
- 2 IDENTICAL INPUT CHANNELS
- CHOPPED OR ALTERNATE SWITCHING
- AMPLITUDE CALIBRATOR

The Type 516 is a dual-trace, semi-portable instrument ideally suited to bench work applications. Vertical calibrated deflection factor is 0.05 V/cm for each channel, with four operating modes. The Type 516 provides small size and light weight combined with simple operation and reliable performance making it suitable for many laboratory and field applications.

CHARACTERISTIC SUMMARY

VERTICAL

(2 Identical Channels)

BANDWIDTH—DC to 15 MHz.

RISETIME—23 ns.

CALIBRATED DEFLECTION FACTOR—50 mV/cm to 20 V/cm.

INPUT RC—1 megohm paralleled by approx 20 pF.

HORIZONTAL

CALIBRATED TIME BASE—0.2 μ s/cm to 2 s/cm.

X5 MAGNIFIER—Operates over full time base, increases fastest rate to 40 ns/cm.

EXTERNAL INPUT—1.5 V/cm to approx 25 V/cm. DC to 500 kHz at 1.5 V/cm.

CRT

DISPLAY AREA—6 x 10 cm.

ACCELERATING VOLTAGE—4 kV.

PHOSPHOR—P31.

OTHER

AMPLITUDE CALIBRATOR—50 mV to 100 V, approx 1-kHz squarewave.

POWER REQUIREMENTS—105 to 125 V or 210 to 250 V, 50 to 60 Hz, approx 300 W.

VERTICAL DEFLECTION

(2 Identical Channels)

BANDWIDTH

DC to 15 MHz at 3-dB down. Low-frequency 3-dB-down point is approx 2 Hz with AC coupling, approx 0.2 Hz with included 10X probe.

RISETIME

23 ns.

DEFLECTION FACTOR

50 mV/cm to 20 V/cm in 9 calibrated steps, 1-2-5 sequence. All steps accurate within 3%. Uncalibrated, continuously variable between steps and to approx 50 V/cm. Warning light indicates uncalibrated setting.

INPUT RC

1 megohm paralleled by approx 20 pF.

MAXIMUM INPUT VOLTAGE

600 V combined DC and peak AC.

OPERATING MODES

Channel A only; Channel B only; Alternate; Chopped; 3.3 μ s segments of each channel are displayed (chopping rate 150 kHz). Chopped transient blanking is provided. Polarity; either channel may be operated as normal or inverted.

SIGNAL DELAY

Permits viewing the leading edge of waveform.

HORIZONTAL DEFLECTION

TIME BASE

0.2 μ s/cm to 2 s/cm in 22 calibrated steps (1-2-5 sequence), accurate within 3%. Uncalibrated, continuously variable between steps and to approx 6 s/cm. Warning light indicates uncalibrated setting.

X5 MAGNIFIER

Operates over full time base, increases fastest rate to 40 ns/cm. Accuracy of magnified time base is within 5%. A neon light indicates when the magnifier is in use.

EXTERNAL INPUT

Variable between approx 1.5 V/cm to 25 V/cm. DC to 500 kHz at 1.5 V/cm (3-dB-down).

OTHER

Gate output: positive-going rectangular pulse with same duration as time base; approx 25 V amplitude.

Sawtooth output: positive-going ramp with same duration as time base; approx 150 V amplitude.

TRIGGER

MODES

Manual level selection; Automatic; Preset Stability; HF SYNC. Automatic triggering may be used for signal repetition rates between approx 60 Hz to 2 MHz, eliminating the need for re-adjusting TRIGGERING LEVEL while sequentially viewing signals of different amplitudes, shapes, and repetition rates. With no input, automatic triggering occurs at an approx 50-Hz rate, providing a convenient reference trace. HF SYNC assures a steady display of sinewaves to approx 20 MHz.

COUPLING

AC, DC, or AC LF reject.

SOURCES

Internal; External; or Line.

REQUIREMENTS

AC coupling requires 2-mm deflection (internal) or 0.5 V external at 1 kHz, increasing to 5 mm deflection or 1.5 V external at 2 MHz; low-frequency response is 3-dB down at approximately 16 Hz. AC low-frequency reject attenuates frequencies below 16 kHz. DC coupling requires 5-mm deflection (internal) or 0.5 V external from DC to 1 kHz, increasing to 2-cm deflection or 1.5 V external at 2 MHz. Automatic triggering requires 5-mm deflection (internal) or 1 V external

from 50 Hz to 1 kHz, increasing to 1-cm deflection or 3 V external at 2 MHz. HF sync requires 2-cm deflection or 2 V external at 20 MHz.

OTHER CHARACTERISTICS

AMPLITUDE CALIBRATOR

Approx 1-kHz squarewave; 50 mV to 100 V peak to peak in 11 steps (1-2-5 sequence); accurate within 3%.

TEKTRONIX CRT

Round, 5-inch, flat-faced tube with helical post-accelerating anode. 4-kV accelerating potential. Edge-lighted graticule is scaled with 6 vertical and 10 horizontal centimeter divisions. P31 phosphor normally supplied. A rear panel switch provides blanking voltage to eliminate switching transients when operating in the chopped mode. External terminal permits Z-axis modulation AC coupled to the cathode.

DIMENSIONS AND WEIGHTS

Height	14 ¹ / ₁₆ in	35.7 cm
Width	9 ³ / ₄ in	24.8 cm
Depth	21 ¹³ / ₁₆ in	55.4 cm
Net weight	43 ¹ / ₂ lb	19.8 kg
Domestic shipping weight	≈53 lb	≈24.1 kg
Export-packed weight	≈66 lb	≈30 kg

POWER REQUIREMENTS

105 V to 125 V or 210 V to 250 V, 50 to 60 Hz, wired for 117 V center. Power consumption is approx 300 watts.

Changing taps insures regulation as follows:

110	99 to 117 volts	220	198 to 235 volts
117	105 to 125 volts	234	210 to 250 volts
124	111 to 132 volts	248	223 to 265 volts

INCLUDED STANDARD ACCESSORIES

Two P6006 probe packages (010-0127-00); 3 to 2 wire adapter (103-0013-00); 3-conductor power cord (161-0010-03); Smoke gray filter (378-0567-00); Patch cord, BNC-to-BNC, 18 in (012-0087-00); Patch cord, BNC-to-banana plug, 18 in (012-0091-00); Post jack, BNC (012-0092-00); two instruction manuals (070-0225-00).

OPTIONAL ACCESSORIES

Optional accessories extend the usefulness of the Type 516 in certain applications. The standard 10X probes supplied with the instrument satisfy most measurement requirements. Listed optional probes may be better suited for particular applications. Other probes are available for current and high-voltage measurements. A complete list of accessory items can be found in the catalog accessory pages.

RACKMOUNT ADAPTER

Consists of a cradle to support the Type 516 in any standard 19-inch relay rack, and a mask to fit around the regular instrument panel. Rack height requirement is 15³/₄ inches, order 040-0277-00

SCOPE-MOBILE® CART

Model 201-1: tilt locking in any of nine positions for convenience in viewing Type 516. 5-inch rubber wheels permit easy transport between locations

C-12 CAMERA

f/1.9, 1:0.85 lens; Polaroid Land* Pack-Film Back. Beam-splitting mirror provides on-axis binocular view of the CRT display, eliminating parallax

C-12 Camera adapter, order 016-0226-00

PROBES

P6007 100X Probe Package, order 010-0150-00

P6028 1X Probe Package, order 010-0074-00

* Registered Trade-Mark Polaroid Corporation

Please refer to Terms and Shipment, General Information page.

TYPE 519

DC-to-1 GHz OSCILLOSCOPE

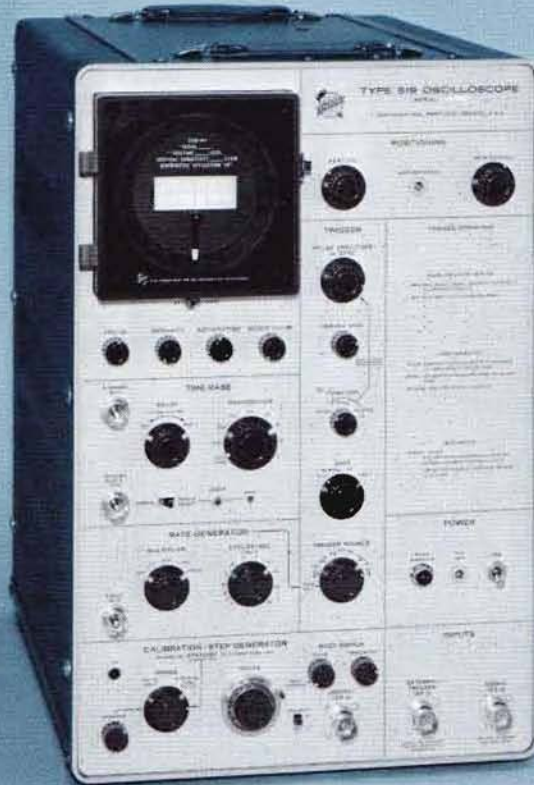

- **SINGLE-SHOT PHOTOGRAPHS AT 2 NS/CM**
- **0.004-INCH SPOT SIZE**
- **SENSITIVE WIDEBAND TRIGGER SYSTEM**
- **SYNCHRONIZATION TO OVER 1 GIGAHERTZ**
- **VSWR, 1.25, OR LESS, TO 1 GIGAHERTZ**
- **DISTRIBUTED-DEFLECTION CRT**
- **BUILT-IN DELAY LINE**

The Tektronix Type 519 Oscilloscope is a calibrated, high-speed, laboratory instrument designed for observation, measurement, and photographic recording of fractional nanosecond risetimes. A 2 x 6 cm viewing area, coupled with 24-kV accelerating potential, affords bright displays with excellent resolution. Performance features include: bandwidth from DC to beyond 1 gigahertz, risetime less than 0.35 ns, deflection factor ≤ 10 V/cm, linear sweeps to 2 ns/cm, sweep delay through 35 ns, and a wideband trigger system. The single unit houses a fixed signal delay line, a convenient sweep-delay control, a pulse-rate generator, a standard amplitude and waveshape generator, and regulated power supplies and high-voltage supply. Only one connection is necessary for normal operation—a connection of the signal from the device under test.

Combining simple operation with laboratory precision and reliability, the Type 519 ideally suits single-shot or random nuclear events. In addition, the bandwidth permits applications to general measurements where oscilloscope risetime must be less than signal risetime.

CHARACTERISTIC SUMMARY

VERTICAL

BANDWIDTH—DC to 1 GHz.
RISETIME—less than 0.35 ns.
DEFLECTION FACTOR— ≤ 10 V/cm.
INPUT IMPEDANCE— $125 \Omega \pm 2\%$.

HORIZONTAL

CALIBRATED TIME BASE—2 to 1000 ns/cm.
SWEEP DELAY—0 to 35 ns.

CRT

DISPLAY AREA—2 x 6 cm.
ACCELERATING VOLTAGE—24 kV.
PHOSPHOR—P11.

OTHER

CALIBRATION-STEP GENERATOR—0 to 10 V into 125Ω or 0 to 1 V into 50Ω , calibrated and continuously variable. (0.1 ns risetime, approx.) Approximately 750 Hz repetition rate.
POWER REQUIREMENTS—105 to 125 V or 210 to 250 V, approx 650 watts.

VERTICAL DEFLECTION

BANDWIDTH

DC to 1 GHz at 3-dB down.

RISETIME

Less than 0.35 ns.

DEFLECTION FACTOR

≤ 10 V/cm.

INPUT IMPEDANCE

$125 \Omega \pm 2\%$.

MAXIMUM INPUT SIGNAL

± 15 VDC or 15 V RMS, or ± 100 -V pulse. Maximum power input is 1.8 watts.

SIGNAL DELAY

45 ns approx. Permits viewing of leading edge of triggering waveform.

HORIZONTAL DEFLECTION

TIME BASE

2 ns/cm to 1000 ns/cm in 9 calibrated steps (1-2-5 sequence), accurate within 3%.

SWEEP DELAY

Sweep start delayed 0—35 ns.

SINGLE SWEEP

After a single sweep is generated, the sweep circuit is locked out until the RESET button is pressed then sweep fires on next trigger. An external jack is provided for remote control of single sweep operation.

SYNCHROSCOPE OPERATION

The output signal from either the +TRIGGER 50Ω , the DELAYED +GATE 50Ω , or the +RATE 50Ω connector can be used to control an external device.

RATE GENERATOR

Output pulse approx 15 V, risetime ≤ 0.8 ns, duration approx 10 ns. Repetition rate variable between 3 Hz and 30 kHz.

TRIGGER

MODES

Pulse—Permits choice of a free-running sweep or a stable sweep which can be triggered on random or uniform repetition rates up to approx 50 MHz.

Sync—Permits stable displays of signals occurring at a constant repetition rate to over 100 MHz.

HF Sync—Permits the sweep to be synchronized with signals from approx 100 MHz to over 1 GHz.

SOURCES

Internal, external, calibration-step generator, or rate generator.

REQUIREMENTS

Two trace widths vertical deflection and 1 ns or greater duration (Internal) or 20 mV or greater amplitude and 1 ns or greater duration (External). Sweep triggers on either the positive or negative slope of the triggering signal.

TRIGGER GAIN

Four gain settings of X0.2, NORMAL, X5, and X20 provide for attenuation or amplification of trigger signals.

MISCELLANEOUS

CALIBRATION STEP GENERATOR

A step-waveform of approximately 750 Hz repetition rate, with amplitude continuously variable and calibrated from 0 to 10 V into 125Ω , or 0 to 1 V into 50Ω (through a T50/T125 adapter) is available at a front-panel $125\text{-}\Omega$ connector. Risetime is approximately 0.1 ns and either polarity can be selected. Continuously variable uncalibrated amplitudes of 0 to 50 V into 125Ω are also available.

CATHODE-RAY TUBE

5 in round, flat-faced tube. 24 kV accelerating potential. Spot diameter at normal intensity 0.004 inch. Maximum x-ray radiation at a distance of two inches from the faceplate does not exceed 0.7 millirems per hour (human limit is 2.5 millirems per hour). At normal viewing distances, x-ray radiation is essentially zero. Normally supplied with P11 phosphor.

GRATICULE

Edge-lighted, 2 cm by 6 cm divisions. The horizontal center line markings are 5 mm apart and the vertical center line markings are 2 mm apart. Illumination is controlled by a front-panel knob. The graticule can be dropped out of view if desired.

CAMERA MOUNTING

A special camera-mounting adapter with swing-away hinging easily accepts a Tektronix C-27-662R Camera. Please refer to the Camera Section for complete description.

POWER REQUIREMENTS

105 V to 125 V or 210 V to 250 V, 50 to 60 Hz, typically 650 watts. Factory wired for 105 V to 125 V. May be ordered wired for 210 V to 250 V operation.

SINGLE-SHOT PHOTOGRAPHY

A single-shot exposure using a Type C-27-662R Camera was used to take the picture at the right. The display shows a ≈ 1 GHz damped wave at 2 ns/cm. The waveform was enlarged 2 times to represent the actual size of the CRT display.

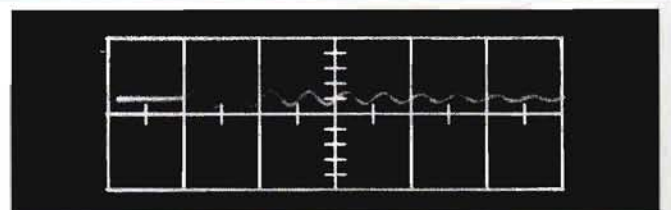

TYPE 519

DIMENSIONS AND WEIGHTS

Height	22 $\frac{1}{4}$ in	56.5 cm
Width	14 $\frac{5}{8}$ in	37.2 cm
Depth	25 $\frac{1}{4}$ in	64.1 cm
Net weight	97 lb	44.1 kg
Domestic shipping weight	\approx 130 lb	\approx 59 kg
Export-packed weight	\approx 169 lb	\approx 77 kg

INCLUDED STANDARD ACCESSORIES

Viewing hood (016-0001-01); two 125 Ω terminations (017-0051-00); two 125 Ω insertion units (017-0013-00); 125 Ω coupling capacitor (017-0018-00); 125 Ω 1-GHz timing standard (017-0019-00); Double-button contact assembly (017-0032-00); Panel adapter assembly (017-0033-00); Cable connector (017-0035-00); 125 Ω min loss attenuator, T50/T125 (017-0052-00); 125 Ω adapter N50/N125 (017-0053-00); 125 Ω adapter, T50/N125 (017-0055-00); Delay-line equalizer (017-0057-00); 1-ns cable (017-0507-00); 2-ns cable (017-0508-00); 5-ns cable (017-0509-00); 10-ns cable (017-0510-00); 3 to 2-wire adapter (103-0013-00); Phone jack plug (134-0069-00); 3-conductor power cord (161-0010-03); Walnut box (202-0083-00); Two reed switches (260-0693-00); Accessory box tray (436-0030-00); Two instruction manuals (070-0243-00).

OPTIONAL ACCESSORIES

Optional accessories serve to extend the usefulness of the Type 519 in certain applications. This listing covers only the more commonly used items. The termination, cables, and adapters supplied with the instrument satisfy most measurement requirements. A complete list of accessory items can be found in the catalog accessory pages.

ATTENUATORS, ADAPTERS, AND CABLES

125- Ω 2:1 attenuator, order 017-0071-00
125- Ω 5:1 attenuator, order 017-0049-00
125- Ω 10:1 attenuator, order 017-0050-00
125- Ω adapter N50/T125, order 017-0054-00
125- Ω 90° elbow assembly, order 017-0043-00
125- Ω 20-ns cable, order 017-0511-00

SCOPE-MOBILE® CART

Provides portability between various operating areas and serves as a convenient working surface for Type 519, order Model 202-1, Mod 52

CAMERA

Ultra-high writing rate—f1.3, 1:0.5—Polaroid* Roll-Film back, order C-27-662R

*Registered Trade-Mark Polaroid Corporation

Please refer to Terms and Shipment, General Information page.

NTSC VECTORSCOPE

NEW



- **PUSH-BUTTON OPERATING CONVENIENCE**
- **AMPLITUDE CALIBRATED DISPLAYS**
- **CHROMINANCE PHASE AND AMPLITUDE, LUMINANCE AMPLITUDE, DIFFERENTIAL PHASE AND DIFFERENTIAL GAIN MEASUREMENTS**
- **LUMINANCE CHANNEL PERMITS R, G, B AND Y PRESENTATIONS**
- **ALL SILICON SOLID-STATE, COOL, QUIET OPERATION**

The Tektronix Type 520 NTSC Vectorscope is designed to measure luminance, hue and saturation of the NTSC composite color television signal. Self-canceling pushbutton switches permit rapid selection of displays for quick analysis of television signal characteristics, and to check Vectorscope calibration. All solid-state circuitry provides low power consumption and cool, quiet operation.

Dual inputs provide time-shared displays for comparison of input-output signal phase and gain distortion. A chrominance channel is provided which demodulates the chrominance signal to obtain color information from the composite video signal for use in VECTOR, LINE SWEEP, R, G, B, I, Q, Differential Gain (dA) and Differential Phase (dφ) displays. A luminance channel separates and displays the luminance (Y) component of the composite color signal. The Y component is combined with the output of the chrominance demodulators for R, G and B displays at a line rate.

A digital line selector permits the display of a single line Vertical Interval Test Signal from a selected line of either field 1 or field 2.

VECTOR PRESENTATION

The vector presentation graphically displays the relative phase and amplitude of the chrominance signal on polar coordinates. To identify these coordinates the graticule (See Fig 1) has points which correspond to the proper phase and amplitude of the primary and complementary colors: R (Red), B (Blue), G (Green); Cy (Cyan), Y_L (Yellow) and M_e (Magenta).

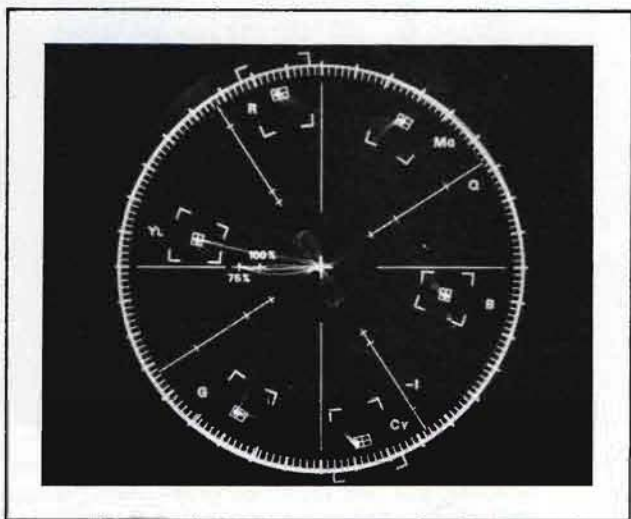

Fig. 1—Vector presentation of NTSC color bar signal.

Any errors in the color encoding, video tape recording or transmission processes which change these phase and/or amplitude relationships cause color errors in the television receiver picture. The polar coordinate type of display such as that obtained on the Type 520 CRT has proved to be the best method for portraying these errors.

The polar display permits measurement of hue in terms of relative phase of the chrominance signal with respect to the color burst. Saturation is expressed in terms of the displacement from center (radial length) toward the color point which corresponds to 75% (or 100%) saturation of the particular color being measured.

The outer boxes around the color points correspond to phase and amplitude error limits per FCC requirements ($\pm 10^\circ$, $\pm 20\%$). The inner boxes indicate $\pm 2.5^\circ$ and 2.5 IRE units and correspond to phase and amplitude error limits per EIA specification RS-189, amended for 7.5% setup.

An internally generated test circle matched with the vector graticule verifies quadrature accuracy, horizontal to vertical gain balance and gain calibration for chrominance signal amplitude measurements. Two methods of measuring phase-shift are provided. Large phase-shifts can be accurately read from the parallax-free vector graticule. A precision calibrated phase shifter with a range of 30° , spread over 30 inches of dial length, is provided for measuring small phase-shifts.

LINEAR-SWEEP PRESENTATION

The linear time base operates at the line rate. Color signals are demodulated along any desired axis, I, Q, R-Y, B-Y, etc. and displayed at the line rate on a linear time base.

DUAL DISPLAY

In dual-channel operation, successive samples of channels A and B are displayed on a time-shared basis. The switching rate is locked to horizontal sync and switching transients are blanked. Input-output signals from video equipment can be conveniently compared on channel A and B for phase and/or amplitude distortion. The subcarrier processing channel contains two uncalibrated 0° to 360° phase-shifters and one 30° CALIBRATED PHASE shifter. While viewing channel A or B, either of the uncalibrated phase-shifters, $A\phi$ or $B\phi$, can be switched into the subcarrier processing channel. $A\phi$ and $B\phi$ will lock to channel A and B respectively, when A and B channel are time-shared, permitting independent phase control of channel A and B displays. Phase shifts caused by unequal signal paths are easily cancelled, leaving only phase and amplitude distortion caused by equipment deficiencies. Video cable lengths can be accurately matched for time delay at color subcarrier frequency to less than 0.5° phase difference. Accurate amplitude measurements of chrominance and luminance are provided from the CRT. An internal 1-V luminance amplitude calibration test signal is provided to check the gain accuracy of channel A and B amplifiers and the luminance channel.

DIFFERENTIAL GAIN AND DIFFERENTIAL PHASE MEASUREMENTS

The two main chrominance-signal distortions are differential gain and differential phase. Both can be measured on the

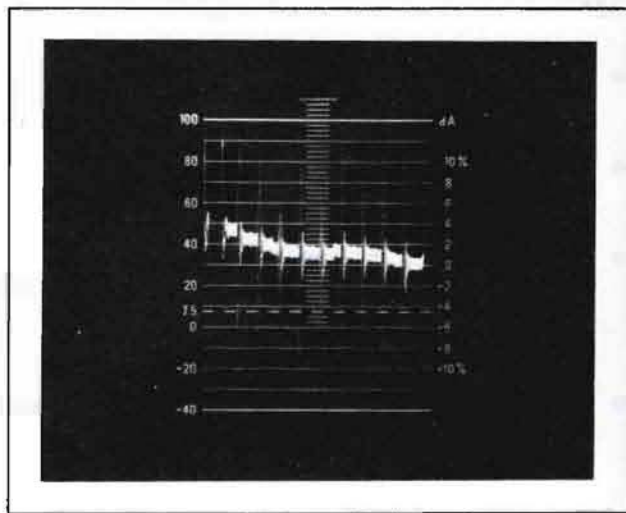

Fig. 2—Differential Gain presentation using a modulated staircase signal. The right side of the graticule is marked in % of gain distortion. From white to black luminance levels the indicated gain distortion is 3%.

Type 520 Vectorscope. Differential gain (Fig 2) is a change in color subcarrier amplitude as a function of luminance. In the reproduced color picture, the saturation will be distorted in the areas between the light and dark portions of the scene. The IRE graticule major divisions represent % of voltage gain or loss when making a differential gain measurement. The 520 permits differential gain measurements with accuracy to better than 1%.

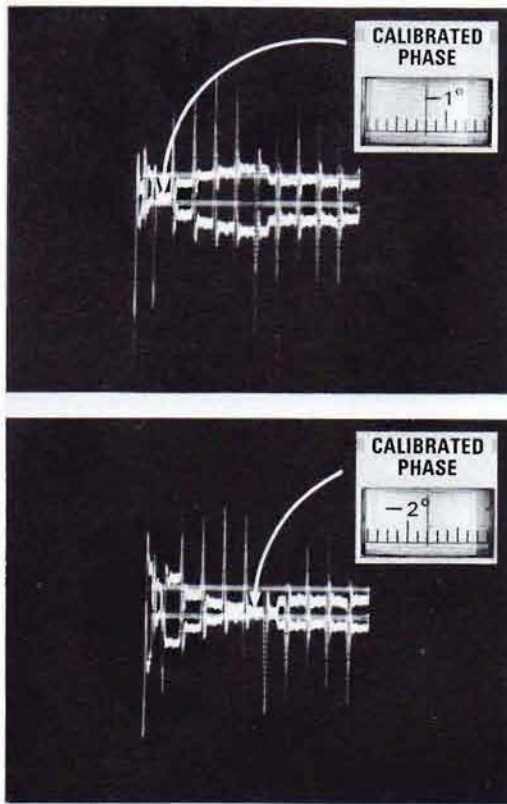
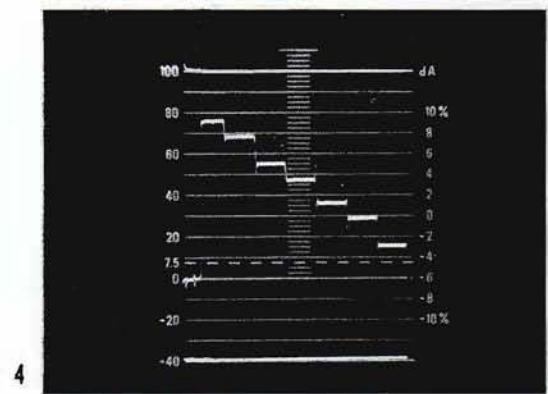

Fig. 3—Differential Phase presentation using a modulated stair-step signal. A trace overlay technique provides excellent resolution for measuring small phase changes. From reference point in top photo (1st step of stairstep signal overlaid) to point of measure in second photo (5th step overlaid) represents 1.4° differential phase distortion.

Differential phase (Fig 3) is a phase modulation of the chrominance signal by the luminance signal. In the reproduced color picture, the hue will vary with scene brightness. Differential gain and differential phase may occur separately or together. The causes of these distortions are amplitude non-linearity and time delay that are not independent of the signal level. Differential phase is read from the precision calibrated phase shift control. Dial resolution is excellent with 1° phase shift represented by approximately 1 inch of dial movement. The vertical deflection of the display is greatly magnified and inverted on alternate lines allowing the use of a trace overlay technique and the slide-back method for measuring small phase changes. The CALIBRATED PHASE control provides direct readout of differential phase. Using the standard linearity test signal, differential phase of 0.2° can be measured.

RED (R), GREEN (G), BLUE (B) AND LUMINANCE (Y) OBSERVATIONS

The Type 520 provides a luminance channel which permits the separation and display of the luminance (Y) component from the composite color signal (Fig 4). The Y component can also be combined with the output of the chrominance demodulators for R, G and B displays at a line rate (Figs 5, 6, 7). Amplitude measurements of color signal components can be made with an accuracy of 3%.



4

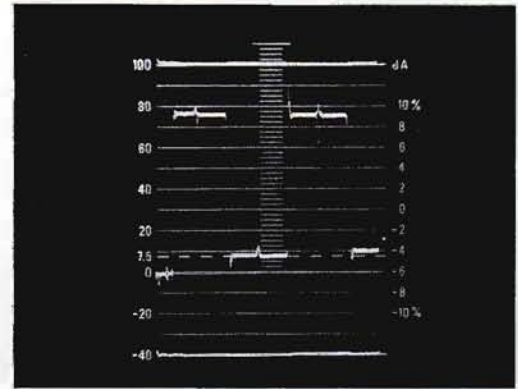

5

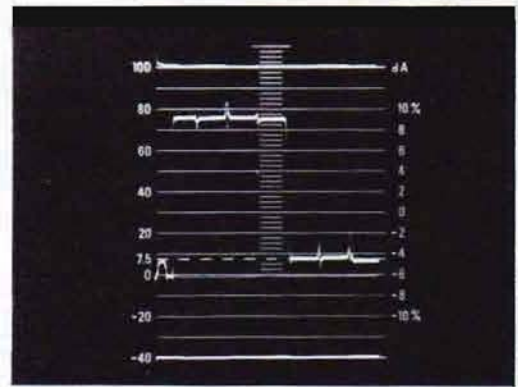

6

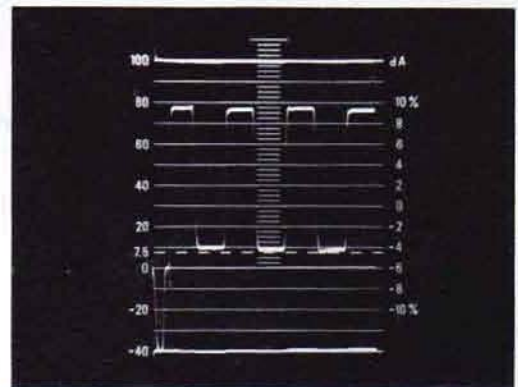

7

Line sweep presentations of the luminance (Fig. 4), Red (Fig. 5), Green (Fig. 6), and Blue (Fig. 7), components of the NTSC color bar signal.

TYPE **520** **R520**

VERTICAL INTERFIELD TEST SIGNAL OBSERVATION

Vertical Interval Test Signals from preselected lines of either field 1 or field 2 can be displayed on the Type 520 Vectorscope.

Binary counters operate in conjunction with the field selector to select lines in either field that may carry suitable test signals. These circuits enable the Vectorscope to be used for measuring differential gain and differential phase from test signals transmitted in the vertical blanking interval of color broadcasts.

Normally, lines 18 and 19 in either field 1 or field 2 are selected by means of the VITS 18 and VITS 19 pushbuttons in conjunction with the FIELD switch. Internal quick-disconnect jumper wires permit selecting any line from 7 through 21 of either field. Intensity and focus are automatically adjusted for optimum viewing of VITS.

GRATICULE

Two separate graticules provide references for vector and line sweep displays. The parallax-free vector graticule, or the IRE graticule, is automatically selected and edge-lighted concurrent with operating mode selection.

Z AXIS INPUT

The Z-AXIS INPUT connector accepts external trace-brightening pulses for intensifying a portion of the display during the time of interest. A 1-V negative-going pulse is required.

VIDEO INPUTS

Dual input connectors (Fig 8) for each channel permit 75- Ω loop through operation with a bridging resistance greater than 15 k Ω and a bridging capacitance less than 9 pF.

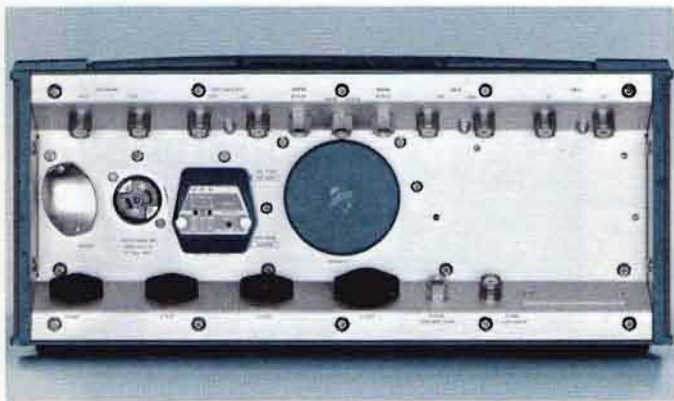

Fig. 8—Rear view of R520 Vectorscope. The mounting angle of the coax connectors permit connecting cables to leave the instrument without protruding excessively and with a minimum of clearance space required.

POWER REQUIREMENTS

90 to 136 VAC or 180 to 272 VAC, 47 to 63 Hz, 95 watts maximum at 115 V and 60 Hz. Rear panel selector provides rapid accommodation for six line-voltage ranges.

ENVIRONMENTAL CAPABILITIES

Ruggedly designed to withstand temperature and altitude variations, vibration, shock, and transportation. Listed instrument characteristics are valid over a temperature range of 0° C to +50° C ambient.

MECHANICAL CHARACTERISTICS

The Type 520 Vectorscope is available in two mechanical configurations. A cabinet model (Type 520) (Fig 9) and a rackmount model (Type R520). Both instruments are electrically identical. The R520 mounts in a 19-inch rack and is provided with slide-out chassis tracks for convenient access to internal components.



Fig. 9—Cabinet model.

DIMENSIONS AND WEIGHTS

TYPE 520	Height	7 in	17.8 cm
	Width	16 $\frac{7}{8}$ in	42.8 cm
	Depth	20 in	50.8 cm
	Net Weight	33 lb	15 kg
TYPE R520	Height	7 in	17.8 cm
	Width	19 $\frac{1}{8}$ in	48.6 cm
	Depth	20 in	50.8 cm
	Net Weight	33 lb	15 kg
Domestic shipping weight		\approx 61 lb	\approx 27.7 kg
Export-packed weight		\approx 82 lb	\approx 37.3 kg

INCLUDED STANDARD ACCESSORIES

TYPE 520: Smoke-gray filter, installed (378-0581-00); camera gasket and mounting screws (016-0114-00); power cord (161-0036-00); 3 to 2-wire adapter (103-0013-00); 2 instruction manuals (070-0639-00).

TYPE R520. Same as Type 520 but includes rackmounting hardware.

OPTIONAL ACCESSORIES

C-27 TRACE RECORDING CAMERA

f/1.9, 1:0.5 lens; Polaroid Land* Pack-Film back.
Order C-27-549

Type 520 to C-27 Camera Adapter, order 016-0225-00

*Registered Trade-Mark, Polaroid Corporation.

PAL VECTORSCOPE

NEW

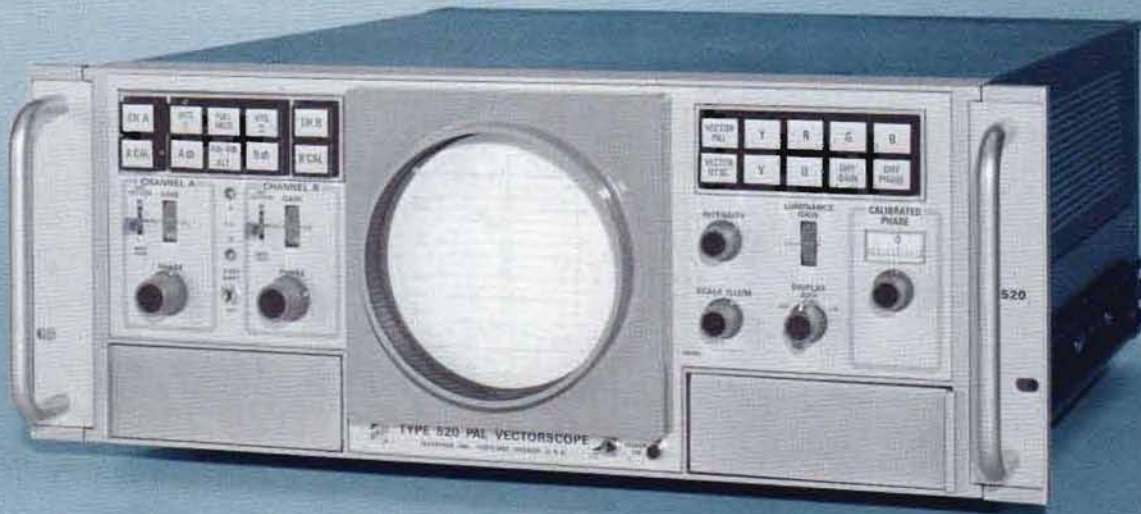

- **PUSH-BUTTON OPERATING CONVENIENCE**
- **AMPLITUDE CALIBRATED DISPLAYS**
- **CHROMINANCE PHASE AND AMPLITUDE, LUMINANCE AMPLITUDE, DIFFERENTIAL PHASE AND DIFFERENTIAL GAIN MEASUREMENTS**
- **LUMINANCE CHANNEL PERMITS R, G, B AND Y PRESENTATIONS**
- **ALL SILICON SOLID-STATE, COOL, QUIET OPERATION**

The Tektronix Type 520 PAL Vectorscope is designed to measure luminance, hue and saturation of the PAL composite color television signal. Self-canceling pushbutton switches permit rapid selection of displays for quick analysis of television signal characteristics, and to check Vectorscope calibration. All solid-state circuitry provides low power consumption and cool, quiet operation.

Dual inputs are provided permitting time-shared displays for comparison of input-output signal phase and gain distortion. A chrominance channel is provided which demodulates the chrominance signal to obtain color information from the composite video signal for use in VECTOR PAL, VECTOR NTSC, R, G, B, U, V, Differential Gain and Differential Phase displays. A luminance channel separates and displays the luminance [Y] component of the composite color signal. The Y component is combined with the output of the chrominance demodulators for R, G and B displays at a line rate.

VECTOR PRESENTATION

The vector presentation graphically displays the relative phase and amplitude of the chrominance signal on polar coordinates. To identify these coordinates the graticule (See Fig 1) has points which correspond to the proper phase and amplitude of the primary, complementary and conjugate chrominance vectors: Red (R) (r), Green (G) (g), Blue (B) (b), Cyan (Cy) (cy), Magenta (Mg) (mg) and Yellow (Yl) (yl).



Fig. 1A—Vector PAL presentation of PAL color bar signal.



Fig. 1B—Vector NTSC presentation of PAL color bar signal.

Any errors in the color encoding, video tape recording or transmission processes which change these phase and/or amplitude relationships cause color errors in the television receiver picture. The polar coordinate type of display such as that obtained on a vectorscope has proved to be the best method for portraying these errors.

The polar display permits measurement of hue in terms of relative phase of the chrominance signal with respect to the color burst. Saturation is expressed in terms of the displacement from center (radial length) toward the color point which corresponds to 75% (or 100%) saturation of the particular color being measured.

The outer boxes around the color points correspond to phase and amplitude error limits ($\pm 10^\circ$, $\pm 20\%$). The inner boxes indicate $\pm 3^\circ$ phase angle and $\pm 5\%$ amplitude.

(+V), (+V and -V) and (-V) vector displays are provided,

permitting observation of the 135° and 235° burst-related color information.

An internally generated test circle matched with the vector graticule verifies quadrature accuracy, horizontal to vertical gain balance and gain calibration for chrominance signal amplitude measurements. Two methods of measuring phase-shift are provided. Large phase-shifts can be accurately read from the parallax-free vector graticule. A precision calibrated phase shifter with a range of 30° , spread over 30 inches of dial length, is provided for measuring small phase-shifts.

LINEAR-SWEEP PRESENTATION

The linear time base operates at the line rate. Color signals are demodulated along any desired axis, U, V, etc. and displayed at the line rate on a linear time base.

DUAL DISPLAY

In dual-channel operation, successive samples of channels A and B are displayed on a time-shared basis. The switching rate is locked to horizontal sync and switching transients are blanked. Input-output signals from video equipment can be conveniently compared on channel A and B for phase and/or amplitude distortion. The subcarrier processing channel contains two uncalibrated 0° to 360° phase-shifters and one 30° CALIBRATED PHASE shifter. While viewing channel A or B, either of the uncalibrated phase-shifters, $A\phi$ or $B\phi$, can be switched into the subcarrier processing channel. $A\phi$ or $B\phi$ will lock to channel A and B respectively, when A and B channel are time-shared, permitting independent phase control of channel A and B displays. Phase shifts caused by unequal signal paths are easily cancelled, leaving only phase and amplitude distortion caused by equipment deficiencies. Video cable lengths can be accurately matched for time delay at color subcarrier frequency to less than 0.5° phase difference. Accurate amplitude measurements of chrominance and luminance are provided from the CRT. An internal 1-V luminance amplitude calibration test signal is provided to check the gain accuracy of channel A and B amplifiers and the luminance channel.

DIFFERENTIAL GAIN AND DIFFERENTIAL PHASE MEASUREMENTS

The two main chrominance-signal distortions are differential gain and differential phase. Both can be measured on the Type 520 PAL Vectorscope. Differential gain (Fig 2) is a change

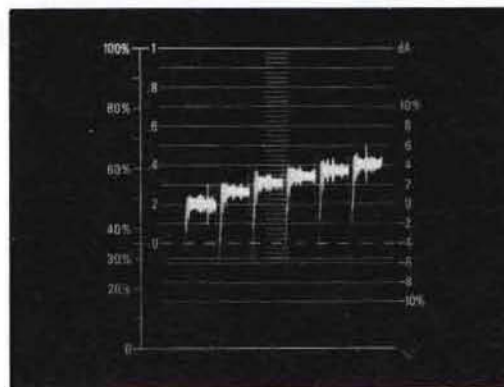

Fig. 2—Differential Gain presentation using a modulated staircase signal. The right side of the graticule is marked in % of gain distortion. From white to black luminance levels the indicated gain distortion is 4%.

in color subcarrier amplitude as a function of luminance. In the reproduced color picture, the saturation will be distorted in the areas between the light and dark portions of the scene. The luminance graticule major divisions represent % of voltage gain or loss when making a differential gain measurement. The 520 PAL Vectorscope permits differential gain measurements with accuracy to better than 1%.

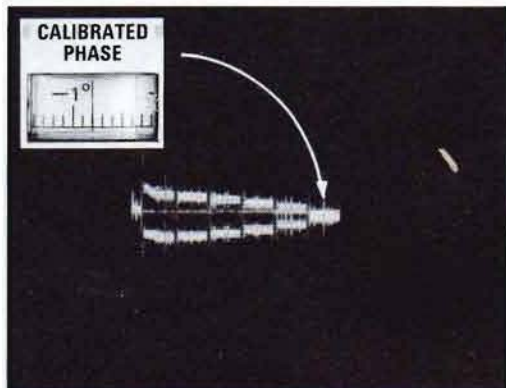
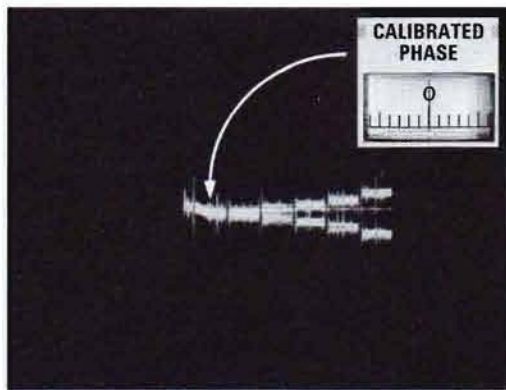
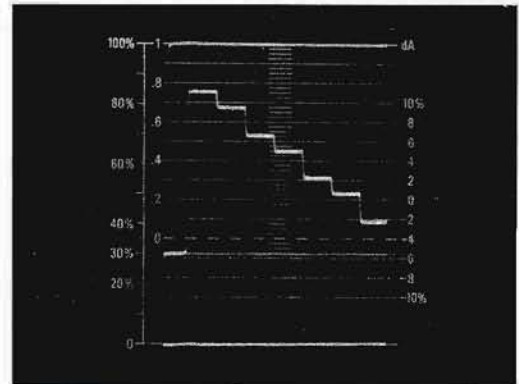

Fig. 3—Differential Phase presentation using a modulated staircase signal. A trace overlay technique provides excellent resolution for measuring small phase changes. From reference point in top photo (1st step of staircase signal overlaid) to point of measure in bottom photo (6th step overlaid) represents 1.2° differential phase distortion.

Differential phase (Fig 3) is a phase modulation of the chrominance signal by the luminance signal. In the reproduced color picture, the hue will vary with scene brightness. Differential gain and differential phase may occur separately or together. The causes of these distortions are amplitude non-linearity and time delay that are not independent of the signal level. Differential phase is read from the precision calibrated phase shift control. Dial resolution is excellent with 1° phase shift represented by approximately 1 inch of dial movement. The vertical deflection of the display is greatly magnified and inverted on alternate lines allowing the use of a trace overlay technique and the slide-back method for measuring small phase changes. The CALIBRATED PHASE control provides direct readout of differential phase. Using the standard linearity test signal, differential phase of 0.2° can be measured.

4



5

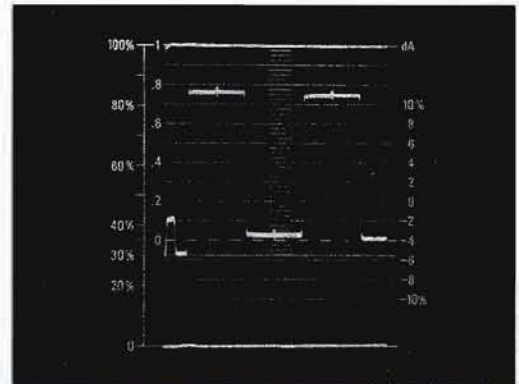

6

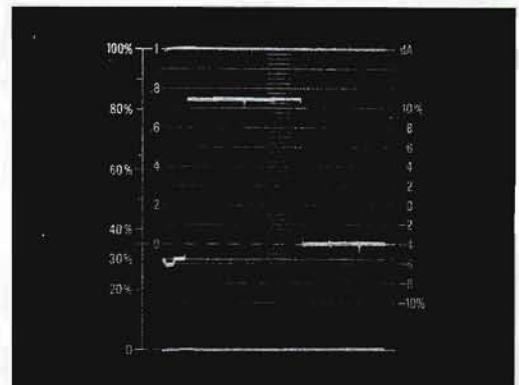

7

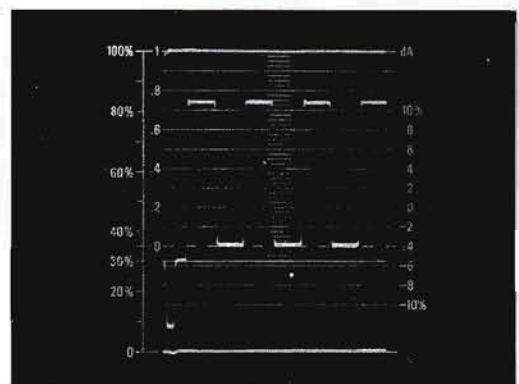

Line sweep presentations of the luminance (Fig. 4), Red (Fig. 5), Green (Fig. 6), and Blue (Fig. 7), components of the PAL color bar signal.

TYPE **520** **R520**

RED (R), GREEN (G), BLUE (B) AND LUMINANCE (Y) OBSERVATIONS

The Type 520 PAL Vectorscope provides a luminance channel which permits the separation and display of the luminance (Y) component from the composite color signal (Fig 4). The Y component can also be combined with the output of the chrominance demodulators for R, G and B displays at a line rate (Figs 5, 6, 7). Amplitude measurements of color signal components can be made with an accuracy of 3%.

VERTICAL INSERTION TEST SIGNAL OBSERVATION

Vertical Insertion Test Signals from preselected lines of either field 1 and 3 or field 2 and 4 can be displayed on the Type 520 PAL Vectorscope.

Binary counters operate in conjunction with the field selector to select lines in either field that may carry suitable test signals. These circuits enable the Vectorscope to be used for measuring differential gain and differential phase from test signals transmitted in the vertical blanking interval of color broadcasts.

Normally, lines 17 and 18 in field 1 and 3 and lines 330 and 331 in field 2 and 4 are selected by means of the VITS I and VITS II pushbuttons in conjunction with the VIT FIELD switch. Internal quick-disconnect jumper wires permit selecting any line from 4 through 22 or 316 through 335. Intensity and focus are automatically adjusted for optimum viewing of VITS.

GRATICULE

Two separate graticules provide references for vector and line sweep displays. The parallax-free PAL vector graticule, or the luminance graticule, is automatically selected and edge-lighted concurrent with operating mode selection.

Z AXIS INPUT

The Z-AXIS INPUT connector accepts external trace-brightening pulses for intensifying a portion of the display during the time of interest. A 1-V negative-going pulse is required.

VIDEO INPUTS

Dual input connectors (Fig 8) for each channel permit 75-Ω loop through operation with a bridging resistance greater than 15 kΩ and a bridging capacitance less than 14 pF.

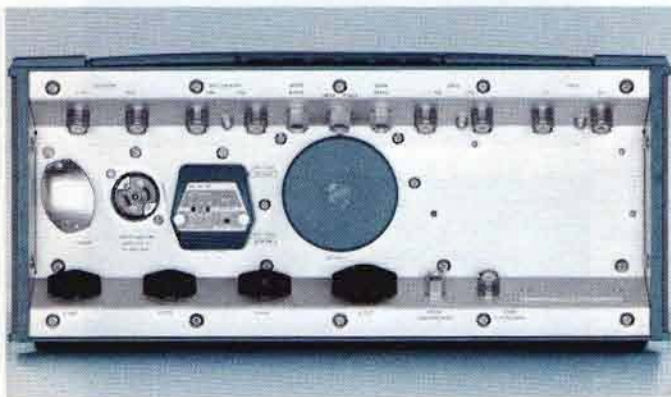

Fig. 8—Rear view of 520 PAL Vectorscope. The mounting angle of the coax connectors permit connecting cables to leave the instrument without protruding excessively and with a minimum of clearance space required.

POWER REQUIREMENTS

90 to 136 VAC or 180 to 272 VAC, 47 to 63 Hz, 95 watts maximum at 115 V and 60 Hz. Rear panel selector provides rapid accommodation for six line-voltage ranges.

ENVIRONMENTAL CAPABILITIES

Listed instrument characteristics are valid over a temperature range of 0°C to +50°C ambient.

MECHANICAL CHARACTERISTICS

The Type 520 PAL Vectorscope is available in two mechanical configurations. A cabinet model (Type 520 MOD 188M) (Fig 9) and a rackmount model (Type R520 MOD 188M). Both instruments are electrically identical. The R520 MOD 188M mounts in a 19-inch rack and is provided with slide-out chassis tracks for convenient access to internal components.

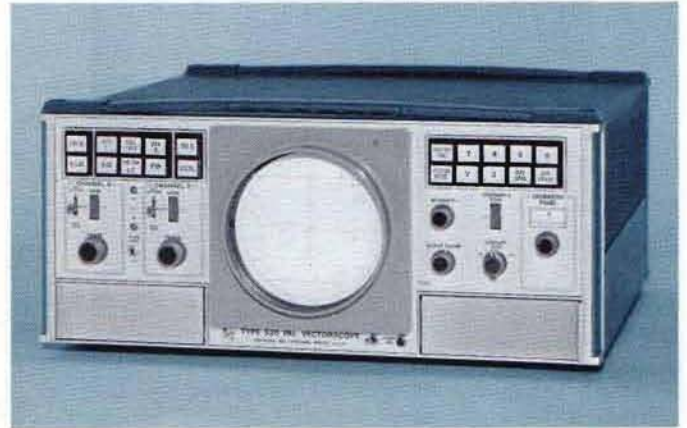

Fig. 9—Cabinet model.

DIMENSIONS AND WEIGHTS

TYPE 520	Height	7 in	17.8 cm
MOD 188M	Width	16 ⁷ / ₈ in	42.8 cm
	Depth	20 in	50.8 cm
	Net Weight	33 lb	15 kg
TYPE R520	Height	7 in	17.8 cm
MOD 188M	Width	19 ¹ / ₈ in	48.6 cm
	Depth	20 in	50.8 cm
	Net Weight	33 lb	15 kg

INCLUDED STANDARD ACCESSORIES

TYPE 520 MOD 188M: Smoke-gray filter (378-0581-00); camera gasket and mounting screws (016-0247-00); power cord (161-0036-00); 3 to 2-wire adapter (103-0013-00); 2 instruction manuals (070-0639-00).

TYPE R520 MOD 188M: Same as Type 520 MOD 188M but includes rackmounting hardware.

ORDERING INFORMATION

Cabinet model PAL Vectorscope, order TYPE 520 MOD 188M

Rackmount model PAL Vectorscope, order TYPE R520 MOD 188M

OPTIONAL ACCESSORIES

C-27 TRACE RECORDING CAMERA

f/1.9, 1:0.5 lens; Polaroid Land* Pack-Film back.

Order C-27-549

Type 520 to C-27 Camera Adapter, order 016-0225-00

*Registered Trade-Mark, Polaroid Corporation.

Please refer to Terms and Shipment, General Information page.

TELEVISION WAVEFORM MONITORS



- **LINE SELECTOR**
- **FLAT TO 8 MHz**
- **4 FREQUENCY RESPONSES**
- **POSITIVE FIELD SELECTOR**
- **COOL—QUIET—CLEAN**
- **NO FAN—ONLY 80 WATTS**
- **AVAILABLE FOR USE WITH SEVERAL TV STANDARDS**

The Type 529 and RM529 bring to the Industry a new flexibility in waveform monitoring: signal-level monitoring, bandwidth and differential gain measurements, sine²-pulse and bar testing, monitoring Vertical Interval Test signals, transmitter percent-of-modulation measurements, YRGB displays (in conjunction with color-processing amplifiers) and others. Included are four video response characteristics, HIGH-PASS, LOW-PASS, IEEE, and FLAT. Both instruments feature FLAT RESPONSE to 8 MHz, assuring excellent waveform fidelity for sine squared testing with 2T, T and 1/2T pulses.

DC RESTORATION maintains the back porch at an essentially constant level despite changes in signal amplitude, APL, and color burst, and may be turned off for viewing other than video signals. The circuit can easily be modified for sync-tip restoration.

Sensitivity range is 0.12 volts to 1.5 volts for full-scale deflection. Full-scale calibration at 0.714 V or 1.00 V is provided.

BRIGHT WAVEFORM DISPLAYS in line selector operation are obtained with a highly-efficient 5-inch aluminized CRT. The instrument uses the best of both solid-state and vacuum-tube circuitry resulting in improved stability and reliability. These instruments do not require a fan, resulting in cleaner operation and complete freedom from noise.

HORIZONTAL SELECTION provides 2-field or 2-line displays, plus calibrated sweep rates of 0.125 H/cm or 0.25 H/cm. Either calibrated rate may be delayed for line selection. SWEEP MAGNIFICATION extends the sweep rate by X5 or X25, offering calibrated sweep rates from 0.250 H/cm to 0.005 H/cm. POSITIVE FIELD SELECTION assures stable displays in the presence of random noise bursts and video switching. The LINE SELECTOR permits detailed study of any portion of any desired line(s), and a front panel switch selects lines 16 through 21 for viewing VIT signals. A VIDEO-OUTPUT AMPLIFIER supplies video and a brightening pulse to the associated picture monitor, intensifying the same line, or lines, displayed on the instrument when using the LINE SELECTOR.

TYPE **529** **RM529**

VIDEO FEATURES

INPUTS

Two unbalanced inputs may be used with either 75- Ω loop-through or bridging connection (input R & C is 1 Meg and 24 pF). Alternatively, one balanced, differential input may be used.

DEFLECTION FACTOR

120 mV to 1.5 V full scale. Continuously variable between ranges. Calibrated full-scale: 1.0, 0.50 and 0.20 V.

FREQUENCY RESPONSE

4 response characteristics provide: FLAT: +0.0 — 0.1 dB to 6 MHz; +0.0 — 0.3 dB to 8 MHz. IRE-Spec 23S-1 of 1958 (amended): 3.58 MHz —20 dB. HIGHPASS: 3.58 MHz plus and minus 400 kHz at —3 dB. LOW PASS: —18 dB at 500 kHz.

LOW FREQUENCY TILT

Displays 50-Hz square wave with less than 1% tilt.

LINEARITY

Differential gain and multiburst axis shift: 1% or less.

DC RESTORER

Keyed back porch* type eliminates drift in DC-coupled vertical amplifier. Does not distort color burst. Blanking level shift due to color burst less than 1 IRE unit. Waveform will remain on screen if there is a loss of sync pulses for DC restorer keying. DC restorer may be disabled by front-panel switch.

VERTICAL AMPLIFIER

May be DC-coupled to diode demodulator as in % Video Modulation Monitoring. Details are available in manual.

GAIN STABILITY

$\pm 1\%$ over rated line voltage and ambient temperature ranges.

VIDEO OUTPUT

Signal is provided for driving a picture or line monitor with amplitude into 75 ohms approx equal to input signal to 529/RM529.

TIME-BASE FEATURES

CALIBRATED TIME BASE

0.125 H/cm. Magnifier extends calibrated time base to 0.025 H/cm and 0.005 H/cm. Accuracy is $\pm 3\%$. Rep rate is $\frac{1}{2}$ of the TV line rate. The time base can be calibrated using TV signals. Color burst is displayed without phase interlace.

UNCALIBRATED TIME BASE

2 LINE: Triggered time base with rep rate of $\frac{1}{3}$ TV line frequency. Provides complete 2-line display with horizontal blanking centered on the screen.

2 FIELD: Synchronized time base with rep rate the same as the TV frame rate. Entire frame of video is displayed with the vertical blanking centered on the screen. Time base will free-run in the absence of signal, indicating loss of incoming signal.

TIME-BASE MAGNIFIER

X5 and X25. Accuracy $\pm 3\%$. Magnifier expands the center of the display, convenient for monitoring equalizing or serrated pulses.

*Sync tip restoration available by simple modification.



COLOR CAMERA YRGB DISPLAYS

Can be used with color camera processing amplifiers providing these sequential signals and the staircase signal. To provide YRGB display directly, switching is done in the color processing amplifier. Receptacle to interconnect color processing amplifier (relay control, staircase signal input, and ground) is provided on rear panel.

VIT SELECTOR

Front-panel switch selects lines 16 through 21. Knob position indicates line selected for viewing.

LINE SELECTOR

Variable delay allows any line of either field to be viewed.

FIELD SELECTOR

Positive-acting field selection.

TRIGGER SELECTION

Stable triggering on composite video signals. INTERNAL: 200 mV to 1 V or more, peak to peak. EXTERNAL: 250 mV to 1 V or more, peak to peak.

OTHER FEATURES

REGULATED POWER SUPPLY

Operates on 115 V or 230 V line $\pm 10\%$ RMS. LINE FREQUENCY: 50-60 Hz. POWER CONSUMPTION: Approx 80 W at 115 V, 60 Hz.

TEKTRONIX CATHODE-RAY TUBE

Flat-faced, 5 in rectangular CRT, operating at 5.5 kV accelerating potential. Calibrated viewing area, 7 x 10 cm. Electrical beam rotator provides trace alignment. P-31 phosphor is normally supplied. Scale illumination: Variable edge-lighting.

CALIBRATOR

Two internal calibration voltages of 0.714 V and 1.00 V on 1-volt full-scale range of VERTICAL GAIN switch. An external calibration signal may be used. Internal calibration pulse amplitude $\pm 1\%$ over ambient temperature range and line-voltage range. Reference is a Zener diode.

VENTILATION

Convection air-cooled. Operating Temperature Range: 0° C to +50° C.

DIMENSIONS AND WEIGHTS

TYPE 529: Height	8 $\frac{1}{4}$ in	21 cm
Width	8 $\frac{1}{2}$ in	21.6 cm
Depth	19 $\frac{9}{16}$ in	49.7 cm
Net weight	25 $\frac{1}{2}$ lb	11.6 kg
Domestic shipping weight	≈ 34 lb	≈ 15.5 kg
Export-packed weight	≈ 47 lb	≈ 21.4 kg

Two Type 529 Waveform Monitors can be mounted side-by-side, or one mounted alongside an associated picture monitor in a standard 19 in rack or console.

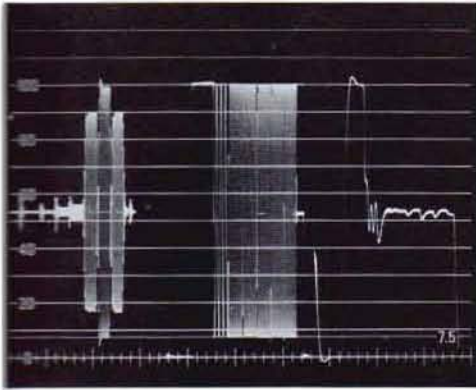

Multiburst Signal. Multiple exposure showing High-pass, Flat, and Low-pass response.

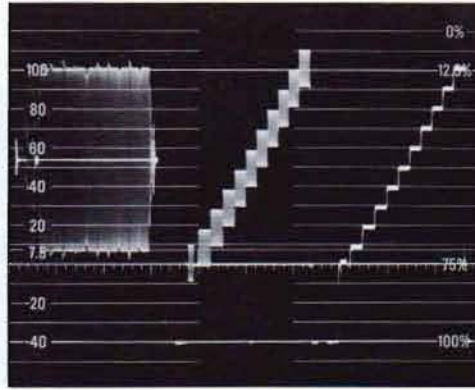

Modulated Stair-Step Signal. Multiple exposure left to right. High-pass position for measuring differential gain, Flat-response position, IEEE response position.

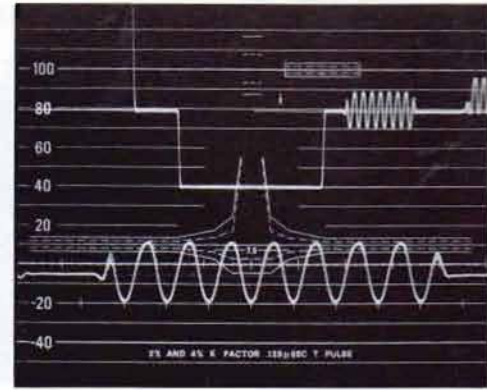

Color-Burst Signal. Double exposure. Top: X5 magnification. Horizontal display: 0.125 H/cm. Bottom: X25 magnification. Horizontal display: 0.125 H/cm.

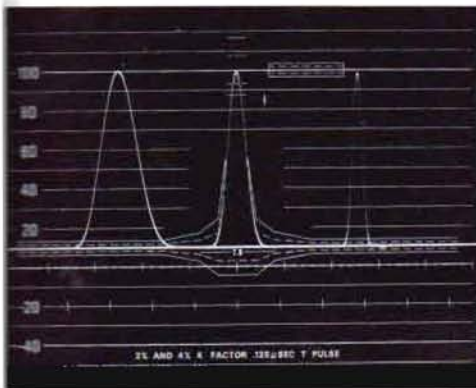

Multiple exposure. Left: 2T. Center: T. Right: $\frac{1}{2}$ T Sine², 0.25, 0.125, 0.0625 μ s HAD.

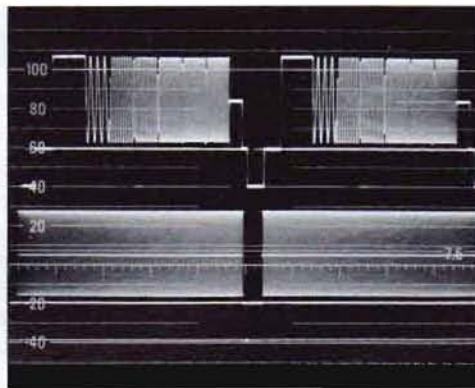

Double exposure showing complete two-field displays and two-line displays.

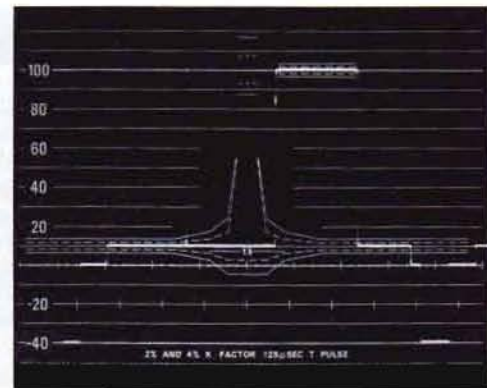

Sine² Pulse and Bar Signal. 0.125 μ s HAD T-Pulse and Bar.

TYPE RM529: Height	5 $\frac{1}{4}$ in	13.3 cm
Width	19 in	48.2 cm
Rack depth	18 $\frac{1}{4}$ in	46.4 cm
Net weight	30 $\frac{1}{2}$ lb	13.9 kg
Domestic shipping weight	\approx 59 lb	\approx 26.8 kg
Export-packed weight	\approx 81 lb	\approx 36.8 kg

Instrument fits standard 19 inch rack, can be pulled forward and tilted 90°.

INCLUDED STANDARD ACCESSORIES

TYPE 529: Smoke-gray light filter (378-0560-00); composite graticule, shown lower center (331-0156-01); noncomposite graticule, shown above left (331-0177-01); dual scale graticule, shown above center (331-0157-00); sine², K factor, and IRE graticule, shown above right, lower left, lower right (331-0161-00); 75-ohm termination resistor (011-0023-00); 3 to 2-wire adapter (103-0013-00); two instruction manuals (070-0509-00). TYPE RM529: same as Type 529 but includes four retainer bars (381-0187-00); one pr tracks (351-0040-02); two instruction manuals (070-0466-00).

TYPE 529 MOUNTING CRADLES

Two different cradle assemblies, with associated bezels, allow the Type 529 Waveform Monitor to be mounted alongside an 8 inch or 9 inch Conrac* Picture Monitor, in a standard 19 inch rack. A cradle and bezel are also available for mounting two Type 529's side-by-side.

*Registered Trademark, Conrac Division, Giannini Controls Corporation

FOR MOUNTING 8 INCH CNB-8 PICTURE MONITOR (REQUIRES 10 $\frac{1}{2}$ INCHES RACK SPACE)

Description	Part Number
Cradle Assembly	014-0021-00
Bezel, for mounting Type 529 on operator's left	014-0027-00
Bezel, for mounting Type 529 on operator's right	014-0028-00

FOR MOUNTING 8 INCH CZB-8 PICTURE MONITOR (REQUIRES 10 $\frac{1}{2}$ INCHES RACK SPACE)

Cradle Assembly	014-0021-00
Bezel, for mounting Type 529 on operator's left	014-0025-00
Bezel, for mounting Type 529 on operator's right	014-0026-00

FOR MOUNTING 9 INCH RNB-9 PICTURE MONITOR (REQUIRES 8 $\frac{3}{4}$ INCHES RACK SPACE)

Cradle Assembly	014-0020-00
Bezel, for mounting Type 529 on operator's left	014-0023-00
Bezel, for mounting Type 529 on operator's right	014-0024-00

FOR MOUNTING TWO TYPE 529 WAVEFORM MONITORS SIDE-BY-SIDE (REQUIRES 8 $\frac{3}{4}$ INCHES RACK SPACE)

Cradle Assembly	014-0020-00
Bezel	014-0022-00

RM529 CRADLE ASSEMBLY

For mounting the Type RM529 in a WECO backless rack, order 426-0309-00

TYPE **529** **RM529**

MULTI-STANDARD WAVEFORM MONITORS

Type 529 or RM529 MOD 188D



The Type 529 Mod 188D and Type RM529 Mod 188D Waveform Monitors are adapted for use with 405-line 50-Hz field rate, 525-line 60-Hz field, 625-line 50-Hz field, and 819-line 50-Hz field standard television systems. Added Vertical RESPONSE switch positions, added MAGNIFIER steps and VARIABLE control, 5 and 10 $\mu\text{s}/\text{cm}$ sweep rates in addition to line and field rates, and a PAL FRAME SELECTOR permit quick setup for use on any of four systems without internal adjustments. Panel marking, color-coordinated with Line/Field indicator light colors, identifies control positions associated with the selected system.

The added PAL FRAME SELECTOR permits normal display from all frames or selection of either frame of the four-field PAL color system cycle.

The Vertical system features selectable DC coupling for Video Input A, and added 1.1 MHz and 4.43 MHz Bandpass positions of the RESPONSE switch. The CALIBRATOR switch has an added 0.70 F.S. position for proper calibration for systems based on a 30-unit (of 100) blanking level. Sweep rates based on line and field intervals are supplemented by fixed 5 $\mu\text{s}/\text{cm}$ and 10 $\mu\text{s}/\text{cm}$ rates. Extra X10 and X20 MAGNIFIER positions and a VARIABLE MAGNIFIER provide maximum flexibility of adjustment for various test signals.

VERTICAL SYSTEM:

Response Switch: Added positions of 1.1 MHz Bandpass (-18 dB at 0.2 MHz) and 4.43 MHz Bandpass (-3 dB bandwidth ≥ 800 kHz) at double sensitivity.

Calibrator: 0.70 F.S. position added for CCIR standards.

Input Switch: Added DC-coupled position for Input A.

HORIZONTAL SYSTEM:

Line/Field Rate Selection: 405/50, 525/60, 625/50, 819/50.

Sweep Rates: 2 Field, 2 Line, 1 Line, 5 $\mu\text{s}/\text{cm}$, and 10 $\mu\text{s}/\text{cm}$.

Line Selector Sweep Rates: 1 Line, 5 $\mu\text{s}/\text{cm}$, 10 $\mu\text{s}/\text{cm}$.

Accuracy: All sweep rates (except 2 Field, an uncalibrated rate) are accurate within 3% (MAG X1).

Magnifier: X1, X5, X10, X20, X25, plus VARIABLE ($\pm 20\%$ from selected step).

Field Switch: Added Even/Odd marking for PAL standards.

Pal Frame Selector: 3-position switch for viewing all frames or selecting alternate frames.

GENERAL:

Line Voltage: $+10\%$, -8% accommodation range at 105, 110, 115, 120, 210, 220, 230, or 240 V center voltage, 50 to 60 Hz. Normally wired and fused for 240 V. Multi-tap transformer can be changed for use with any of the listed nominal line voltages.

Accessories: The following graticules are furnished in addition to the standard 529/RM529 complement: 0-100 unit composite CCIR Video, 30-unit blanking level, p/n 331-0184-00. 0-100 unit composite CCIR Video, with \sin^2 & K factor ruling for 0.1 μs T and 0.2 μs 2T pulses, 2% and 4% K factor, timing line for 4.43 MHz, p/n 331-0185-00 (installed).

OPTIONAL ACCESSORIES

TYPE 529 FIELD CASE

Provides cabinet protection for the Type 529 when used for applications outside of the rack. Aluminum construction, blue vinyl finish; order 016-0084-00

C-27 CAMERA

f/1.9-1:0.85 lens; Polaroid Land⁺ Pack-Film back

Type 529 or RM529 to C-27 Camera Adapter, order 016-0224-00

MESH FILTER

For improving display contrast when viewing under high-ambient light conditions; includes special graticule cover. Order 378-0575-00

CONNECTOR

Used with color processing amplifiers for RGB, etc. displays. Order 134-0049-00

See the catalog accessory pages for additional information on cameras and other accessory items not listed.

*Registered Trade-Mark Polaroid Corporation

Please refer to Terms and Shipment, General Information page.

TELEVISION OSCILLOSCOPE

TYPE 453 AND R453 MOD 127C



An internal TV Sync Separator circuit permits stable internal Line or Field-rate triggering from displayed composite video or composite sync waveforms. External $\div 10$ trigger sources are replaced by internal TV Sync positions providing Line (Horizontal) sync pulses to the B Sweep circuit and either Field (Vertical) or Line sync pulses to the A Sweep circuit.

Individual line selection of VIT (vertical interval test) signals is facilitated by the sweep delay features in the Type 453. The wide range of sweep delays permit accurate alternate-frame color-burst observations in the PAL color system.

Conventional waveform displays and measurements can be made from standard broadcast or closed-circuit TV systems, domestic or overseas, with up to 1201-line, 60-Hz field rates. Other characteristics are the same as Type 453 and R453. See catalog page 38 for complete description.

INCLUDED STANDARD ACCESSORIES

Same as Type 453 except as follows: delete two P6010 3.5 ft 10X probe packages (010-0188-00), add two P6010 6 ft probe packages (010-0185-00), two 6-32 adapters (103-0051-00), two spring phone tip adapters (206-0060-00), one snap-in light filter/TV graticule with 140-unit IRE scale.

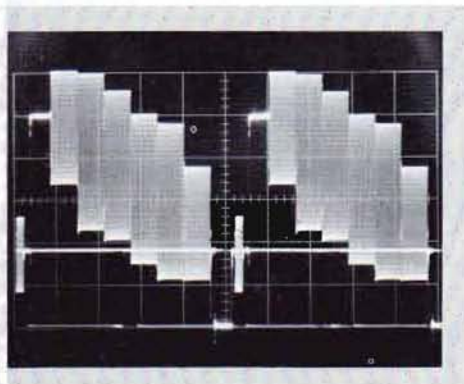

NTSC color bar test signal displayed on the Type 453 MOD 127C.

TELEVISION ACCESSORIES

TV SYNC SEPARATOR

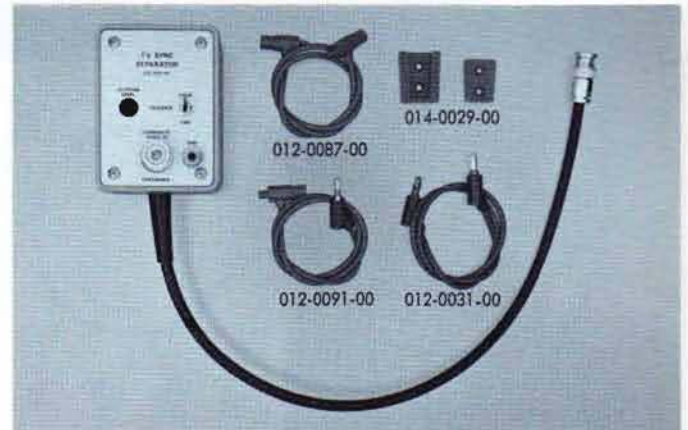

The TV Sync Separator provides the trigger facilities for viewing composite video signals on a conventional oscilloscope. It can be used with Tektronix general-purpose oscilloscopes that have a 100-volt calibrator output. When used with other instruments, a separate 100-V source is required to power the unit.

A front panel switch selects field- or line-rate triggers, and a separate output jack supplies field triggers continuously. The unit has a clipping level control, allowing it to be used with signals ranging from 0.5 V to 8.5 V in amplitude.

POWER REQUIREMENTS—7 mA; operates on 100-V DC, or from the output of an oscilloscope calibrator with a frequency near 1 kHz.

INPUT—Composite video signal from signal source or from Vert Sig Out jack on front panel of oscilloscope.

OUTPUT— ≈ 10 -V negative-going composite sync for line rate triggering or ≈ 6 -V negative-going field-rate triggers. Selected by toggle switch. Also second output for field-rate triggers.

TV SYNC SEPARATOR, with illustrated accessories, order 015-0062-00

VIDEO STAIRCASE DIFFERENTIATOR



The Video Staircase Differentiator permits the use of a general-purpose oscilloscope for measuring amplitude linearity in TV systems.

The staircase differentiator is a filter which differentiates the steps of an unmodulated, linearity staircase (VIT signal) into spikes. The spikes appear on a common-reference level. Amplitude linearity is checked by comparing the amplitude of the spikes on the oscilloscope display. The generator used must supply a staircase having equal risetime, for the output amplitude of the differentiator is proportional to the rate of rise. Input impedance of the differentiator is 75 ohms.

VIDEO STAIRCASE DIFFERENTIATOR, order 015-0075-00

TYPE 531A

DC-to-15 MHz OSCILLOSCOPE

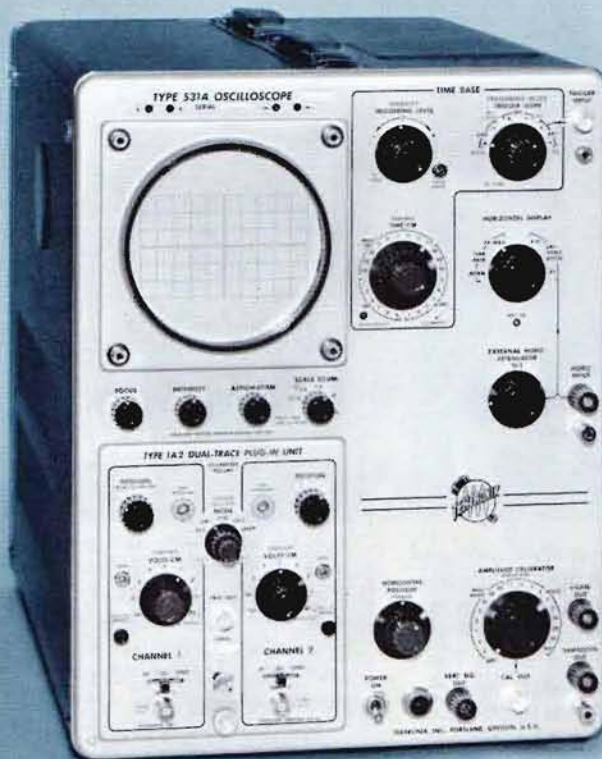

- **6 X 10 CM DISPLAY**
- **ACCEPTS MULTI-TRACE, DIFFERENTIAL, SAMPLING, AND SPECTRUM ANALYZER PLUG-IN UNITS**

The Type R531A is the lowest-cost oscilloscope that accepts Letter-Series and 1-Series Plug-In Units. In common with other Type 530-Series Oscilloscopes, the Type 531A has 10-kV accelerating voltage for bright displays, 6 x 10-cm display area, and a DC-to-15 MHz vertical-deflection system. With spectrum analyzer and sampling plug-in units, measurement capabilities extend into the gigahertz region.

CHARACTERISTIC SUMMARY

VERTICAL

Vertical deflection characteristics are extremely flexible through use of the 1-Series and Letter-Series Plug-In Units.

HORIZONTAL

CALIBRATED TIME BASE—0.1 μ s/cm to 5 s/cm.

X5 MAGNIFIER—Extends time base to 20 ns/cm.

EXTERNAL INPUT—0.2 V/cm to 2 V/cm, DC to 350 kHz.

CRT

DISPLAY AREA—6 x 10 cm.

ACCELERATING VOLTAGE—10 kV.

PHOSPHOR—P2

OTHER

AMPLITUDE CALIBRATOR—0.2 mV to 100 V (1-kHz square wave).

POWER REQUIREMENTS—108, 115, 122, 216, 230, or 244 V ($\pm 9\%$ on each range). 455 watts maximum.

VERTICAL PLUG-IN UNITS			
PLUG-IN UNIT	MINIMUM DEFLECTION FACTOR	BANDWIDTH (—3 dB)	T _R
MULTIPLE TRACE			
1A1 Dual-Trace	50 mV/cm	DC to 15 MHz	24 ns
	5 mV/cm	DC to 14 MHz	25 ns
	≈500 μV/cm	2 Hz to 10 MHz	35 ns
1A2 Dual-Trace	50 mV/cm	DC to 15 MHz	24 ns
CA Dual-Trace	50 mV/cm	DC to 13 MHz	27 ns
1A4 Four-Trace	10 mV/cm	DC to 15 MHz	24 ns
M Four-Trace	20 mV/cm	DC to 14 MHz	25 ns
SINGLE TRACE			
B	50 mV/cm	DC to 14 MHz	25 ns
	5 mV/cm	2 Hz to 10 MHz	35 ns
H	5 mV/cm	DC to 11 MHz	32 ns
K	50 mV/cm	DC to 15 MHz	24 ns
L	50 mV/cm	DC to 15 MHz	24 ns
	5 mV/cm	3 Hz to 14 MHz	25 ns
SPECIAL PURPOSE			
O Operational	50 mV/cm	DC to 14 MHz	25 ns
Q Strain Gage	10 μstrain/div	DC to 6 kHz	60 μs
DIFFERENTIAL			
1A5 Comparator	5 mV/cm	DC to 15 MHz	24 ns
	1 mV/cm	DC to 14 MHz	25 ns
1A6	1 mV/cm	DC to 2 MHz	0.18 μs
1A7A High-Gain	10 μV/cm	DC to 1 MHz	350 ns
		Selectable	
D	1 mV/cm (to 50 mV/cm)	DC to 300 kHz (DC to 2 MHz)	0.18 μs
E	50 μV/cm (to 10 mV/cm)	0.06 Hz to 20 kHz (to 60 kHz) Selectable	6 μs
G	50 mV/cm	DC to 14 MHz	25 ns
W Comparator	1 mV/cm	DC to 7 MHz	50 ns
	50 mV/cm	DC to 13 MHz	27 ns
Z Comparator	50 mV/cm	DC to 10 MHz	35 ns
SPECTRUM ANALYZERS			
1L5	10 μV/cm	10 Hz to 1 MHz	
1L10	—100 dBm	1 MHz to 36 MHz	
1L20	—110 to —90 dBm	10 MHz to 4.2 GHz	
1L30	—105 to —75 dBm	925 MHz to 10.5 GHz	
WIDE-BAND SAMPLING			
1S1	2 mV/cm	DC to 1 GHz	350 ps
1S2 TDR	5mρ/cm	140 ps system risetime	
	5 mV/cm	DC to 3.9 GHz	90 ps

VERTICAL DEFLECTION

BANDWIDTH

DC to 15 MHz at 3-dB down, depending on plug-in unit. See chart.

RISETIME

24 ns, depending on plug-in unit. See chart.

DELAY LINE

Permits viewing leading edge of displayed waveform.

SIGNAL OUTPUT

<10 Hz to >5 MHz at 3-dB down, no load (cathode-follower output). At least 1.5 V for each centimeter of displayed signal.

HORIZONTAL DEFLECTION

TIME BASE

0.1 μs/cm to 5 s/cm in 24 calibrated steps (1-2-5 sequence), accurate within 3%. Uncalibrated, continuously variable between steps and to approx 12 s/cm. Warning light indicates uncalibrated setting.

X5 MAGNIFIER

Operates over full time base, increases fastest rate to 20 ns/cm. Magnified time base accurate within 5%.

EXTERNAL INPUT

Fixed steps of approx 0.2 V/cm and 2 V/cm, continuously variable between steps and to approx 20 V/cm, DC to ≥350 kHz at —3 dB. 50-V maximum input (DC + peak AC) in most sensitive position. Input RC approx 1 MΩ paralleled by approx 40 pF.

SIGNAL OUTPUTS

Gate (positive going from 0 to at least +20 V), sawtooth (positive going from 0 to at least +130 V). Cathode follower outputs.

TRIGGER

MODES

Automatic mode or manual level selection; high-frequency sync. Automatic operation is useful between approx 50 Hz and 2 MHz, minimizes trigger adjustments for signals of different amplitudes, shapes, and repetition rates. With no input (or input less than 50 Hz), automatic triggering occurs at an approx 40-Hz rate, providing a convenient reference trace. High-frequency sync assures a steady display of sine-waves from less than 5 to 30 MHz.

COUPLING

AC, DC or AC LF reject.

SOURCES

Internal (from oscilloscope vertical amplifier), external, or line. External trigger input RC approx 1 MΩ (except 91 kΩ in AC LF reject) paralleled by approx 40 pF. 50-V maximum input (DC + peak AC).

REQUIREMENTS

0.2-cm deflection or 0.2-V external from 150 Hz to 2 MHz, increasing to 1-cm deflection or 1-V external at 5 MHz. Requirements increase below 150 Hz with AC coupling, below 10 kHz with AC low-frequency reject. DC coupling requires 0.4-cm deflection or 0.2-V external from DC to 2 MHz, increasing to 2-cm deflection or 1-V external at 5 MHz. Automatic operation requires 0.2-cm deflection or 0.2 V external from 50 Hz to 1 MHz, increasing to 1-cm deflection or 1-V external at 2 MHz. High-frequency sync requires 2-cm deflection or 2-V external between approx 5 and 30 MHz. ±10-V trigger level selection.

TYPE 531A

CRT

TEKTRONIX CRT

5-in metallized screen, helical post accelerating anode, 10-kV accelerating potential for bright displays. P2 phosphor normally supplied. Z-axis input is AC coupled to CRT cathode, requires 20 V peak to peak for beam modulation at normal intensities.

GRATICULE

External; variable edge lighting. 6x10-cm display area. Vertical and horizontal center lines marked in 2-mm divisions.

DISPLAY FEATURES

Beam-position indicators show direction of CRT beam when off screen. Multi-trace blanking eliminates switching transients from display when multi-trace plug-in unit is operated in chopped mode.

OTHER CHARACTERISTICS

AMPLITUDE CALIBRATOR

0.2-mV to 100-V squarewave, 18 calibrated steps (1-2-5 sequence), accurate within 3%, approx 1-kHz repetition rate.

POWER REQUIREMENTS

Wired for 115-V RMS $\pm 9\%$; transformer taps permit operation at 108, 115, 122, 216, 230, or 244 V ($\pm 9\%$ on each range); 50 to 60 Hz. 455-W maximum power consumption. Can be factory wired for any of the above nominal voltages, if so indicated on order.

DIMENSIONS AND WEIGHTS

Height	17 in	43.2 cm
Width	12 ⁵ / ₁₆ in	32.9 cm
Depth	23 ⁷ / ₈ in	60.7 cm
Net weight	56 ¹ / ₂ lb	25.7 kg
Domestic shipping weight	≈75 lb	≈34.1 kg
Export-packed weight	≈95 lb	≈43.2 kg

INCLUDED STANDARD ACCESSORIES

Two P6006 10X probes (010-0127-00); BNC-to-BNC 18-in patch cord (012-0087-00); BNC-to-banana plug 18-in patch cord (012-0091-00); BNC-post jack (012-0092-00); 3 to 2-wire adapter (103-0013-00); 3-conductor power cord (161-0010-03); smoke-gray light filter (378-0567-00); two instruction manuals (070-0130-00).

OPTIONAL ACCESSORIES

Optional accessories increase measurement capability and provide added convenience. Cameras, probes, Scope-Mobile® Carts and other major accessories are completely described in the catalog accessory pages.

CAMERA

The standard C-12 camera satisfies most trace-recording requirements. For applications that might require a different viewing system, lens, or back, refer to camera descriptions or consult your field engineer, representative, or distributor. Standard C-12: f/1.9—1:0.85 lens, no-parallax viewing, Polaroid Land* Pack-Film back
Type 531A to C-12 Camera adapter, order 016-0226-00

PROBES

The standard 10X probes supplied with the instrument satisfy most measurement requirements; however, optional probes (recommended on plug-in unit pages) may be better suited for particular applications.

SCOPE-MOBILE® CART

Model 202-2: storage drawer, carrier for 2 plug-in units, 9-position tilt-lock oscilloscope tray

RACK-MOUNT ADAPTER

Consists of cradle to support the Type 531A in any standard 19-in relay rack, and mask to fit around the front panel. Requires 17¹/₂-in panel height, order 040-0281-00

TV ACCESSORIES FOR GENERAL-PURPOSE OSCILLOSCOPES

In addition to the Tektronix line of television instruments, accessories are available for use with many Tektronix general-purpose oscilloscopes. A TV Sync Separator provides stable triggering for the display of composite video signals. A Video Staircase Differentiator allows the amplitude linearity of television systems and their components to be measured. See the catalog accessory pages for additional information.

*Registered Trade-Mark Polaroid Corporation

Please refer to Terms and Shipment, General Information page.

DC-to-15 MHz OSCILLOSCOPE

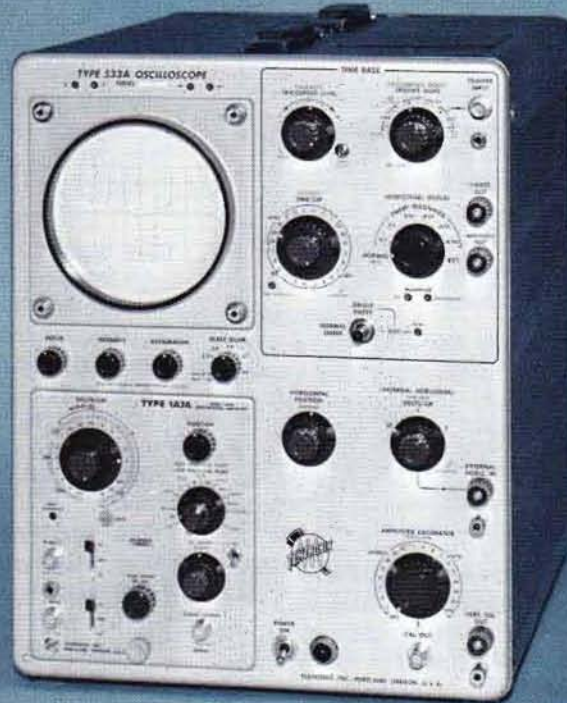

- **X100 SWEEP MAGNIFIER**
- **6 x 10-cm DISPLAY**
- **ACCEPTS MULTI-TRACE, DIFFERENTIAL, SAMPLING, AND SPECTRUM ANALYZER PLUG-IN UNITS**

The Type 533A is a DC-to-15 MHz oscilloscope with a wide range of application coverage through use of versatile Tektronix Plug-In Units. Six different degrees of sweep magnification are available. Sweep lockout and high writing rate are combined for best results in one-shot recording.

Operating convenience results from functionally-grouped controls, a single-knob direct-reading sweep selector, warning lights for uncalibrated sweep-rate and sweep-magnifier settings, beam-position indicators, and built-in blanking for switching transients in multi-trace operation.

CHARACTERISTIC SUMMARY

VERTICAL

Vertical deflection characteristics are extremely flexible through use of the 1-Series and Letter-Series Plug-In Units.

HORIZONTAL

CALIBRATED TIME BASE—0.1 μ s/cm to 5 s/cm.

SWEEP MAGNIFIER—X2, X5, X10, X20, X50, X100. Extends calibrated time base to 20 ns/cm.

EXTERNAL INPUT—0.1 V/cm to 10 V/cm (calibrated) DC to 500 kHz.

CRT

DISPLAY AREA—6 x 10 cm.

ACCELERATING VOLTAGE—10 kV.

PHOSPHOR—P2

OTHER

AMPLITUDE CALIBRATOR—0.2 mV to 100 V; 1-kHz square wave.

POWER REQUIREMENTS—108, 115, 122, 216, 230, or 244 V ($\pm 9\%$ on each range). 500 watts maximum.

TYPE 533A

VERTICAL PLUG-IN UNITS			
PLUG-IN UNIT	MINIMUM DEFLECTION FACTOR	BANDWIDTH (—3 dB)	T _R
MULTIPLE TRACE			
1A1 Dual-Trace	50 mV/cm	DC to 15 MHz	24 ns
	5 mV/cm	DC to 14 MHz	25 ns
	≈500 μV/cm	2 Hz to 10 MHz	35 ns
1A2 Dual-Trace	50 mV/cm	DC to 15 MHz	24 ns
CA Dual-Trace	50 mV/cm	DC to 13 MHz	27 ns
1A4 Four-Trace	10 mV/cm	DC to 15 MHz	24 ns
M Four-Trace	20 mV/cm	DC to 14 MHz	25 ns
SINGLE TRACE			
B	50 mV/cm	DC to 14 MHz	25 ns
	5 mV/cm	2 Hz to 10 MHz	35 ns
H	5 mV/cm	DC to 11 MHz	32 ns
K	50 mV/cm	DC to 15 MHz	24 ns
L	50 mV/cm	DC to 15 MHz	24 ns
	5 mV/cm	3 Hz to 14 MHz	25 ns
SPECIAL PURPOSE			
O Operational	50 mV/cm	DC to 14 MHz	25 ns
Q Strain Gage	10 μstrain/div	DC to 6 kHz	60 μs
DIFFERENTIAL			
1A5 Comparator	5 mV/cm	DC to 15 MHz	24 ns
	1 mV/cm	DC to 14 MHz	25 ns
1A6	1 mV/cm	DC to 2 MHz	0.18 μs
1A7A High-Gain	10 μV/cm	DC to 1 MHz Selectable	350 ns
D	1 mV/cm	DC to 300 kHz	0.18 μs
	(to 50 mV/cm)	(DC to 2 MHz)	
E	50 μV/cm	0.06 Hz to 20 kHz	6 μs
	(to 10 mV/cm)	(to 60 kHz) Selectable	
G	50 mV/cm	DC to 14 MHz	25 ns
W Comparator	1 mV/cm	DC to 7 MHz	50 ns
	50 mV/cm	DC to 13 MHz	27 ns
Z Comparator	50 mV/cm	DC to 10 MHz	35 ns
SPECTRUM ANALYZERS			
1L5	10 μV/cm	10 Hz to 1 MHz	
1L10	—100 dBm	1 MHz to 36 MHz	
1L20	—110 to —90 dBm	10 MHz to 4.2 GHz	
1L30	—105 to —75 dBm	925 MHz to 10.5 GHz	
WIDE-BAND SAMPLING			
1S1	2 mV/cm	DC to 1 GHz	350 ps
1S2 TDR	5m _p /cm	140 ps system risetime	
	5 mV/cm	DC to 3.9 GHz	90 ps

VERTICAL DEFLECTION

BANDWIDTH

DC to 15 MHz at 3-dB down, depending on plug-in unit. See chart.

RISETIME

24 ns, depending on plug-in unit. See chart.

DELAY LINE

Permits viewing leading edge of displayed waveform.

SIGNAL OUTPUT

<10 Hz to >5 MHz at 3-dB down, no load (cathode follower output). At least 1.5 V for each centimeter of displayed signal.

HORIZONTAL DEFLECTION

TIME BASE

0.1 μs/cm to 5 s/cm in 24 calibrated steps (1-2-5 sequence), accurate within 3%. Uncalibrated, continuously variable between steps and to approx 12 s/cm. Warning light indicates uncalibrated setting.

MAGNIFIER

X2, X5, X10, X20, X50, or X100 magnification. Magnified time base accurate within 5% up to 20 ns/cm. Warning light indicates when magnified time base exceeds 20 ns/cm (uncalibrated).

OPERATING MODES

Normal, single sweep.

EXTERNAL INPUT

0.1, 1, and 10 V/cm, accurate within 5%. Uncalibrated, continuously variable between steps and to approx 100 V/cm. DC to ≥500 kHz at —3 dB. 50-V maximum input (DC + peak AC) in most sensitive position. Input RC approx 1 MΩ paralleled by approx 40 pF.

SIGNAL OUTPUTS

Gate (positive going from 0 to at least +20 V), sawtooth (positive going from 0 to at least +130 V). Cathode follower outputs.

TRIGGER

MODES

Automatic mode or manual level selection; high-frequency sync. Automatic operation is useful between approx 50 Hz and 2 MHz, minimizes trigger adjustments for signals of different amplitudes, shapes, and repetition rates. With no input (or input less than 40 Hz), automatic triggering occurs at an approx 50-Hz rate, providing a convenient reference trace. High-frequency sync assures a steady display of sinewaves from less than 5 to 30 MHz.

COUPLING

AC, DC or AC LF reject.

SOURCES

Internal (from oscilloscope vertical amplifier), external, or line. External trigger input RC approx 1 MΩ (except 91 kΩ in AC LF reject) paralleled by approx 40 pF. 50-V maximum input (DC + peak AC).

REQUIREMENTS

0.2-cm deflection or 0.2-V external from 150 Hz to 2 MHz, increasing to 1-cm deflection or 1-V external at 5 MHz. Requirements increase below 150 Hz with AC coupling, below 10 kHz with AC low-frequency reject. DC coupling requires 0.4-cm deflection or 0.2-V external from DC to 2 MHz, increasing to 2-cm deflection or 1-V external at 5 MHz. Automatic operation requires 0.2-cm deflection or 0.2-V external from 50 Hz to 1 MHz, increasing to 1-cm deflection or 1-V external at 2 MHz. High-frequency sync requires 2-cm deflection or 2-V external between approx 5 and 30 MHz. ±10-V trigger level selection.

CRT

TEKTRONIX CRT

5-in metallized screen, helical post accelerating anode, 10-kV accelerating potential for bright displays. P2 phosphor normally supplied. Z-axis input is AC coupled to CRT cathode, requires 20 V peak to peak for beam modulation at normal intensity.

GRATICULE

External; variable edge lighting. 6 x 10-cm display area. Vertical and horizontal center lines marked in 2-mm divisions.

DISPLAY FEATURES

Beam-position indicators show direction of CRT beam when off screen. Multi-trace blanking eliminates switching transients from display when multi-trace plug-in unit is operated in chopped mode.

OTHER CHARACTERISTICS

AMPLITUDE CALIBRATOR

0.2-mV to 100-V squarewave, 18 calibrated steps (1-2-5 sequence), accurate within 3%, approx 1-kHz repetition rate.

POWER REQUIREMENTS

Wired for 115-V RMS $\pm 9\%$; transformer taps permit operation 108, 115, 122, 216, 230, or 244 V ($\pm 9\%$ on each range); 50 to 60 Hz. 500 W maximum power consumption. Can be factory wired for any of the above nominal voltages, if so indicated on order.

DIMENSIONS AND WEIGHTS

Height	17 in	43.2 cm
Width	12 ⁵ / ₁₆ in	32.9 cm
Depth	23 ⁷ / ₈ in	60.7 cm
Net weight	57 ¹ / ₂ lb	26.2 kg
Domestic shipping weight	≈76 lb	≈34.6 kg
Export-packed weight	≈95 lb	≈43.2 kg

INCLUDED STANDARD ACCESSORIES

Two P6006 10X Probes (010-0127-00); BNC-to-BNC 18-in patch cord (012-0087-00); BNC-to-banana plug 18-in patch cord (012-0091-00); BNC-post jack (012-0092-00); 3 to 2-wire adapter (103-0013-00); 3-conductor power cord (161-0010-03); smoke-gray light filter (378-0567-00); two instruction manuals (070-0258-00).

OPTIONAL ACCESSORIES

Optional accessories increase measurement capability and provide added convenience. Cameras, probes, Scope-Mobile® Carts and other major accessories are completely described in the catalog accessory pages.

CAMERA

The standard C-12 camera satisfies most trace-recording requirements. For applications that might require a different viewing system, lens, or back, refer to camera descriptions or consult your field engineer, representative, or distributor. Standard C-12: f/1.9—1:0.85 lens, no-parallax viewing, Polaroid Land* Pack-Film back

Type 533A to C-12 Camera adapter, order 016-0226-00

PROBES

The standard 10X probes supplied with the instrument satisfy most measurement requirements; however, optional probes (recommended on plug-in unit pages) may be better suited for particular applications.

SCOPE-MOBILE® CART

Model 202-2: storage drawer, carrier for 2 plug-in units, 9-position tilt-lock oscilloscope tray

RACK-MOUNT ADAPTER

Consists of cradle to support the Type 533A in any standard 19-in relay rack, and mask to fit around the front panel. Requires 17¹/₂-in panel height, order 040-0281-00

TV ACCESSORIES FOR GENERAL-PURPOSE OSCILLOSCOPES

In addition to the Tektronix line of television instruments, accessories are available for use with many Tektronix general-purpose oscilloscopes. A TV Sync Separator provides stable triggering for the display of composite video signals. A Video Staircase Differentiator allows the amplitude linearity of television systems and their components to be measured. See the catalog accessory pages for additional information.

*Registered Trade-Mark, Polaroid Corporation

Please refer to Terms and Shipment, General Information page.

TYPE 535A RM35A

DC-to-15 MHz OSCILLOSCOPES



- **CALIBRATED SWEEP DELAY**
- **6 x 10-CM DISPLAY**
- **ACCEPTS MULTI-TRACE, DIFFERENTIAL, SAMPLING, AND SPECTRUM ANALYZER PLUG-IN UNITS**

The Type 535A and RM35A Oscilloscopes are versatile laboratory instruments designed for use with all Tektronix Letter-Series or 1-Series Plug-In Units.

The two time-base generators can be used in delayed sweep operation for highly accurate time measurements.

CHARACTERISTIC SUMMARY

VERTICAL

Vertical deflection characteristics are extremely flexible through use of all 1-Series and Letter-Series Plug-In Units.

HORIZONTAL

CALIBRATED TIME BASE—0.1 μ s/cm to 5 s/cm.

X5 MAGNIFIER—Extends time base to 20 ns/cm.

CALIBRATED SWEEP DELAY—2 μ s to 10 s.

EXTERNAL INPUT—0.2 V/cm to 2 V/cm, DC to 350 kHz.

CRT

DISPLAY AREA—6 x 10 cm.

ACCELERATING VOLTAGE—10 kV.

PHOSPHOR—P2

OTHER

AMPLITUDE CALIBRATOR—0.2 mV to 100 V (1-kHz square-wave).

POWER REQUIREMENTS—108, 115, 122, 216, 230, or 244 V (\pm 9% on each range), 550 watts maximum.

VERTICAL PLUG-IN UNITS			
PLUG-IN UNIT	MINIMUM DEFLECTION FACTOR	BANDWIDTH (—3 dB)	T _R
MULTIPLE TRACE			
1A1 Dual-Trace	50 mV/cm 5 mV/cm ≈500 μV/cm	DC to 15 MHz DC to 14 MHz 2 Hz to 10 MHz	24 ns 25 ns 35 ns
1A2 Dual-Trace	50 mV/cm	DC to 15 MHz	24 ns
CA Dual-Trace	50 mV/cm	DC to 13 MHz	27 ns
1A4 Four-Trace	10 mV/cm	DC to 15 MHz	24 ns
M Four-Trace	20 mV/cm	DC to 14 MHz	25 ns
SINGLE TRACE			
B	50 mV/cm 5 mV/cm	DC to 14 MHz 2 Hz to 10 MHz	25 ns 35 ns
H	5 mV/cm	DC to 11 MHz	32 ns
K	50 mV/cm	DC to 15 MHz	24 ns
L	50 mV/cm 5 mV/cm	DC to 15 MHz 3 Hz to 14 MHz	24 ns 25 ns
SPECIAL PURPOSE			
O Operational	50 mV/cm	DC to 14 MHz	25 ns
Q Strain Gage	10 μstrain/div	DC to 6 kHz	60 μs
DIFFERENTIAL			
1A5 Comparator	5 mV/cm 1 mV/cm	DC to 15 MHz DC to 14 MHz	24 ns 25 ns
1A6	1 mV/cm	DC to 2 MHz	0.18 μs
1A7A High-Gain	10 μV/cm	DC to 1 MHz Selectable	350 ns
D	1 mV/cm (to 50 mV/cm)	DC to 300 kHz (DC to 2 MHz)	0.18 μs
E	50 μV/cm (to 10 mV/cm)	0.06 Hz to 20 kHz (to 60 kHz) Selectable	6 μs
G	50 mV/cm	DC to 14 MHz	25 ns
W Comparator	1 mV/cm 50 mV/cm	DC to 7 MHz DC to 13 MHz	50 ns 27 ns
Z Comparator	50 mV/cm	DC to 10 MHz	35 ns
SPECTRUM ANALYZERS			
1L5	10 μV/cm	10 Hz to 1 MHz	
1L10	—100 dBm	1 MHz to 36 MHz	
1L20	—110 to —90 dBm	10 MHz to 4.2 GHz	
1L30	—105 to —75 dBm	925 MHz to 10.5 GHz	
WIDE-BAND SAMPLING			
1S1	2 mV/cm	DC to 1 GHz	350 ps
1S2 TDR	5 m _p /cm	140 ps system risetime	
	5 mV/cm	DC to 3.9 GHz	90 ps

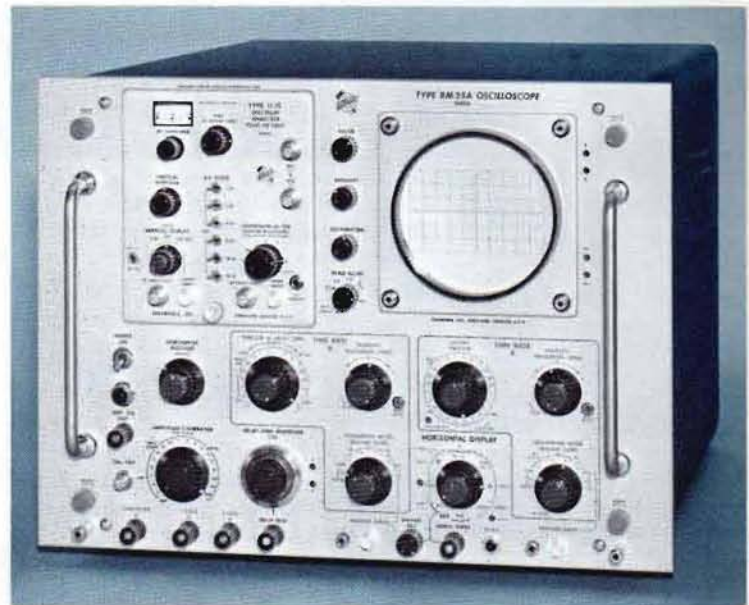

VERTICAL DEFLECTION

BANDWIDTH

DC to 15 MHz at 3 dB down, depending on plug-in unit. See chart.

RISETIME

24 ns, depending on plug-in unit. See chart.

DELAY LINE

Permits viewing leading edge of displayed waveform.

SIGNAL OUTPUT

<10 Hz to >5 MHz at 3-dB down, no load (cathode follower output). At least 1.5 V for each centimeter of displayed signal.

HORIZONTAL DEFLECTION

TIME BASE A

0.1 μs/cm to 5 s/cm in 24 calibrated steps (1-2-5 sequence), accurate within 3%. Uncalibrated, continuously variable between steps and to approx 12 s/cm. Warning light indicates uncalibrated setting.

TIME BASE B

2 μs/cm to 1 s/cm in 18 calibrated steps (1-2-5 sequence), accurate within 3%. Sweep length continuously variable from 4 to 10 cm, allowing use of Time Base B as a repetition-rate generator from 0.1 Hz to 40 kHz.

X5 MAGNIFIER

Operates over full time base, increases fastest Time Base A rate to 20 ns/cm, and the fastest Time Base B rate to 0.4 μs/cm. Magnified time base accurate within 5%.

DELAY TIME

2 μs to 10 s, continuously variable and calibrated, accurate within 1% (3% at 3 slowest sweep rates) of indicated delay ±2 minor dial divisions (add processing time of approx 300 ns at fast sweep rates). Incremental delay-time accurate within 1% ±4 minor divisions. Short-term jitter ≤1/20,000 of total Time Base B delay time.

DELAY MODES

Depending on the setting of the Delayed Sweep stability control, the Delayed Sweep can start immediately at end of delay time, or be triggerable at end of delay time (for jitter-free displays).

OPERATING MODES

Time Base A—Normal, single sweep, delayed by B.
Time Base B—Normal, intensified by A.

TYPE **535A** **RM35A**

EXTERNAL INPUT

Fixed steps of approx 0.2 V/cm and 2 V/cm, continuously variable between steps and to approx 20 V/cm, DC to ≥ 350 kHz at -3 dB. 50 V maximum input (DC + peak AC). Input RC approx 1 M Ω paralleled by approx 47 pF.

SIGNAL OUTPUTS

Gates from both time bases (positive going from 0 to at least +20 V), sawtooth from Time Base A (positive going from 0 to at least +130 V), and a delayed trigger pulse (positive going from 0 to at least +5 V). Cathode-follower outputs.

TRIGGER

MODES

Automatic mode or manual level selection; high-frequency sync on Time Base A. Automatic operation is useful between approx 50 Hz and 2 MHz, minimizes trigger adjustments for signals of different amplitudes, shapes, and repetition rates. With no input (or input less than 50 Hz), automatic triggering occurs at an approx 40 Hz rate, providing a convenient reference trace. High-frequency sync assures a steady display of sinewaves from less than 5 MHz to 30 MHz.

COUPLING

AC or DC; AC LF reject on Time Base A.

SOURCES

Internal (from oscilloscope vertical amplifier), external, or line. External trigger input RC approx 1 M Ω (91 k Ω at AC LF reject) paralleled by approx 40 pF for Time Base A, approx 1 M Ω paralleled by approx 50 pF for Time Base B.

TIME BASE A REQUIREMENTS

0.2-cm deflection or 0.2-V external from 150 Hz to 2 MHz, increasing to 1-cm deflection or 1 V external at 5 MHz. Requirements increase below 150 Hz with AC coupling, below 10 kHz with AC low-frequency reject. DC coupling requires 0.4-cm deflection or 0.2-V external to 2 MHz, increasing to 2-cm deflection or 1-V external at 5 MHz. Automatic operation requires 0.2-cm deflection or 0.2 V external from 50 Hz to 1 MHz, increasing to 1-cm deflection or 1-V external at 2 MHz. High-frequency sync requires 2-cm deflection or 2-V external between approx 5 and 30 MHz. ± 10 -V trigger level range.

TIME BASE B REQUIREMENTS

0.2-cm deflection or 0.2-V external from 150 Hz to 1 MHz, increasing to 1-cm deflection or 1-V external at 3 MHz. Requirements increase below 150 Hz with AC coupling. DC coupling requires 0.4-cm deflection or 0.2-V external to 1 MHz, increasing to 2-cm deflection or 1 V external at 3 MHz. Automatic operation requires 0.2-cm deflection or 0.2-V external from 50 Hz to 1 MHz, increasing to 1-cm deflection or 1-V external at 2 MHz.

CRT

TEKTRONIX CRT

5-in metallized screen, helical post accelerating anode, 10-kV accelerating potential for bright displays. P2 phosphor normally supplied. Z-axis input is AC coupled to CRT cathode, requires 20 V peak to peak for beam modulation at normal intensity.

GRATICULE

External; variable edge lighting. 6 x 10-cm display area. Vertical and horizontal center lines marked in 2-mm divisions.

DISPLAY FEATURES

Beam-position indicators show direction of CRT beam when off screen. Multi-trace blanking eliminates switching transients from display when multi-trace plug-in unit is operated in chopped mode.

OTHER CHARACTERISTICS

AMPLITUDE CALIBRATOR

0.2 mV to 100 V squarewave, 18 calibrated steps (1-2-5 sequence), accurate within 3%, approx 1-kHz repetition rate.

POWER REQUIREMENTS

Wired for 115 V RMS $\pm 9\%$; transformer taps permit operation at 108, 115, 122, 216, 230, or 244 V ($\pm 9\%$ on each range); 50 to 60 Hz. 550 W maximum power consumption. Can be factory wired for any of the above nominal voltages, if so indicated on order.

CABINET MODEL DIMENSIONS AND WEIGHTS

Height	17 in	43.2 cm
Width	12 ⁵ / ₁₆ in	32.9 cm
Depth	23 ⁷ / ₈ in	60.7 cm
Net weight	61 ¹ / ₄ lb	27.9 kg
Domestic shipping weight	≈ 80 lb	≈ 36.4 kg
Export-packed weight	≈ 100 lb	≈ 45.5 kg

RACK MODEL DIMENSIONS AND WEIGHTS

Height	14 in	35.6 cm
Width	19 in	48.3 cm
Rack depth	22 ¹ / ₁₆ in	57.6 cm
Net weight	78 ¹ / ₄ lb	35.6 kg
Domestic shipping weight	≈ 104 lb	≈ 47.3 kg
Export-packed weight	≈ 125 lb	≈ 56.8 kg

RACK MOUNTING

Type RM35A withdraws from its cabinet on slide-out tracks, tilts and locks in 7 positions. Further mounting information on catalog instrument dimensions page.

INCLUDED STANDARD ACCESSORIES

Two P6006 10X probes (010-0127-00); BNC-to-BNC 18-in patch cord (012-0087-00); BNC-to-banana plug 18-in patch cord (012-0091-00); BNC post jack (012-0092-00); 3 to 2-wire adapter (103-0013-00); 3-conductor power cord (161-0010-03); smoke-gray light filter (378-0567-00); two instruction manuals (070-0145-01). Type RM35A also includes mounting hardware.

OPTIONAL ACCESSORIES

Optional accessories increase measurement capability and provide added convenience. Cameras, probes, Scope-Mobile® Carts and other major accessories are completely described in the catalog accessory pages.

CAMERA

The standard C-12 camera satisfies most trace-recording requirements. For applications that might require a different viewing system, lens, or back, refer to camera descriptions or consult your field engineer, representative, or distributor.

Standard C-12: f/1.9—1:0.85 lens, no-parallax viewing, Polaroid Land* Pack-Film back

Type 535A to C-12 Camera adapter, order 016-0226-00

PROBES

The standard 10X probes supplied with the instrument satisfy most measurement requirements; however, optional probes (recommended on plug-in unit pages) may be better suited for particular applications.

SCOPE-MOBILE® CART

Model 202-2: storage drawer, carrier for 2 plug-in units, 9-position tilt-lock oscilloscope tray

TV ACCESSORIES FOR GENERAL-PURPOSE OSCILLOSCOPES

In addition to the Tektronix line of television instruments, accessories are available for use with many Tektronix general-purpose oscilloscopes. A TV Sync Separator provides stable triggering for the display of composite video signals. A Video Staircase Differentiator allows the amplitude linearity of television systems and their components to be measured.

*Registered Trade-Mark Polaroid Corporation

Please refer to Terms and Shipment, General Information page.

DC-to-11 MHz X-Y OSCILLOSCOPE



- **ACCURATE PHASE BALANCE**
- **X-Y or Y-T DISPLAYS**
- **ACCEPTS MULTI-TRACE, DIFFERENTIAL, SAMPLING, AND SPECTRUM ANALYZER PLUG-IN UNITS**

The Type 536 represents a combination of wide-band "X-Y" and general-purpose laboratory oscilloscopes. Identical main amplifiers and a Tektronix CRT with equal X and Y deflection characteristics are the basic components. Using identical wide-band Plug-In Units, horizontal and vertical deflection systems are almost identical. Relative phase shift is less than 1° to 15 MHz, and phase balance can be obtained at any frequency to 30 MHz.

With the Type T Plug-In Unit providing horizontal deflection, and any Letter-Series or 1-Series Plug-In Unit providing vertical deflection, the Type 536 functions as a general-purpose instrument. In order to view the leading edge of a fast-rising waveform, a pretrigger signal occurring approx 0.2 μ s in advance of the signal to be viewed must be applied to the external trigger input of the Type T Unit.

CHARACTERISTIC SUMMARY

VERTICAL AND HORIZONTAL

Vertical and horizontal deflection characteristics are extremely flexible through use of the 1-Series and Letter-Series Plug-In Units.

TIME-BASE DEFLECTION (with Type T Time-Base Generator)

CALIBRATED TIME BASE—0.2 μ s/div to 2 s/div.

5X MAGNIFIER—Extends time base to 40 ns/div.

CRT

DISPLAY AREA—10 x 10 divisions (3 $\frac{1}{8}$ x 3 $\frac{1}{8}$ inches).

ACCELERATING VOLTAGE—4 kV.

PHOSPHOR—P31.

OTHER

AMPLITUDE CALIBRATOR—0.2 mV to 100 V; 1 kHz square wave.

POWER REQUIREMENTS—108, 115, 122, 216, 230, or 244 V (\pm 9% on each range). Approx 625 watts maximum.

TYPE 536

VERTICAL PLUG-IN UNITS			
PLUG-IN UNIT	MINIMUM DEFLECTION FACTOR	BANDWIDTH (—3 dB)	T _R
MULTIPLE TRACE			
1A1 Dual-Trace	50 mV/cm	DC to 11 MHz	32 ns
	5 mV/cm	DC to 10 MHz	35 ns
	≈500 μV/cm	2 Hz to 8 MHz	44 ns
1A2 Dual-Trace	50 mV/cm	DC to 11 MHz	32 ns
CA Dual-Trace	50 mV/cm	DC to 10 MHz	35 ns
1A4 Four-Trace	10 mV/cm	DC to 11 MHz	32 ns
M Four-Trace	20 mV/cm	DC to 10 MHz	35 ns
SINGLE TRACE			
B	50 mV/cm	DC to 10 MHz	35 ns
	5 mV/cm	2 Hz to 9 MHz	40 ns
H	5 mV/cm	DC to 9.5 MHz	37 ns
K	50 mV/cm	DC to 11 MHz	32 ns
L	50 mV/cm	DC to 11 MHz	32 ns
	5 mV/cm	3 Hz to 10 MHz	35 ns
SPECIAL PURPOSE			
O Operational	50 mV/cm	DC to 10 MHz	35 ns
Q Strain Gage	10 μstrain/div	DC to 6 kHz	60 μs
DIFFERENTIAL			
1A5 Comparator	1 mV/cm	DC to 11 MHz	32 ns
1A6	1 mV/cm	DC to 2 MHz	0.18 μs
1A7A High-Gain	10 μV/cm	DC to 1 MHz Selectable	350 ns
D	1 mV/cm (to 50 mV/cm)	DC to 300 kHz (DC to 2 MHz)	0.18 μs
E	50 μV/cm (to 10 mV/cm)	0.06 Hz to 20 kHz (to 60 kHz) Selectable	6 μs
G	50 mV/cm	DC to 10 MHz	35 ns
W Comparator	1 mV/cm	DC to 6.5 MHz	54 ns
	50 mV/cm	DC to 10 MHz	35 ns
Z Comparator	50 mV/cm	DC to 9 MHz	40 ns
SPECTRUM ANALYZERS			
1L5	10 μV/cm	10 Hz to 1 MHz	
1L10	—100 dBm	1 MHz to 36 MHz	
1L20	—110 to —90 dBm	10 MHz to 4.2 GHz	
1L30	—105 to —75 dBm	925 MHz to 10.5 GHz	
WIDE-BAND SAMPLING			
1S1	2 mV/cm	DC to 1 GHz	350 ps
1S2 TDR	5 m _p /cm	140 ps system risetime	
	5 mV/cm	DC to 3.9 GHz	90 ps

APPLICATIONS

In curve-tracing applications the Type 536 extends the range of familiar techniques to today's higher-frequency problems. Differential input, a feature that eliminates the need for a common XY terminal, is available in the wide-band Type G Plug-In Pre-amplifier. A pair of Type G Units provides accuracy needed in many curve-tracing applications.

Some applications for a wide-band "X-Y" oscilloscope:

1. Examination of semiconductor diode characteristics—volts vs amperes plot.
2. Determination of ferromagnetic material characteristics.
3. Linear amplifier distortion measurement.
4. Limiting or expanding-amplifier performance measurements.
5. Displaying pressure vs volume diagrams.
6. Analyzing amplitude selector type circuits such as Schmitt, diode pick-off, etc.
7. Checking regulated power supply performance.
8. Measurement of voltage coefficient of resistors.
9. Performance tests of various modulation systems such as AM, suppressed carrier, FM, PTM, PAM, etc.
10. Performance tests of demodulators for above modulation systems.
11. Determining gating circuit characteristics.
12. Function generator— $y = f(x)$.

VERTICAL AND HORIZONTAL DEFLECTION

Two identical systems

BANDWIDTH

DC to 11 MHz at 3-dB down, depending on plug-in unit. See chart.

RISETIME

32 ns, depending on plug-in unit. See chart.

SIGNAL OUTPUT

At least 1 V for each division of displayed signal. Cathode follower outputs.

PHASE DIFFERENCE IN X-Y MODE

<1° from DC to 15 MHz with two Type K Units at 50 mV/div. Front-panel control for amplifier phasing to 30 MHz, with signals not overdriving the Type K Units.

HORIZONTAL DEFLECTION

With Type T Plug-In Unit

TIME BASE

0.2 μs/div to 2 s/div in 22 calibrated steps (1-2-5 sequence), accurate within 3%. Uncalibrated, continuously variable between steps and to approx 5 s/div. Warning light indicates uncalibrated setting.

X5 MAGNIFIER

Operates over full time base, increases fastest rate to 40 ns/div. Magnified display accurate within 5%.

SIGNAL OUTPUTS

Gate (positive going from 0 to at least +20 V), sawtooth (positive going from 0 to at least +150 V). Cathode follower outputs.

TRIGGER

With Type T Plug-In Unit

MODES

Automatic or manual level selection; high-frequency sync. Automatic operation is useful between approx 50 Hz and 2 MHz, minimizes trigger adjustments for signals of different amplitudes, shapes, and repetition rates. With no input (or input less than 40 Hz), automatic triggering occurs at an approx 50-Hz rate, providing a convenient reference trace. High-frequency sync assures a steady display of sinewaves from approx 5 to 15 MHz.

COUPLING

AC, DC, or AC LF reject.

SOURCES

External or line. External trigger input RC approx 100 kΩ paralleled by approx 25 pF.

REQUIREMENTS

0.2V from DC to 1 MHz, increasing to 10 V at 5 MHz. Requirements increase below 100 Hz with AC coupling, below 10 kHz with AC low-frequency reject. High-frequency sync requires 2V from approx 5 to 15 MHz.

CRT

TEKTRONIX CRT

Identical characteristics for vertical and horizontal deflection plates. 4-kV accelerating potential. P31 phosphor normally supplied. Z-axis inputs: Front panel connector provides AC or DC coupling to CRT grid. Rear panel connector is AC coupled to CRT cathode. Both require 20V peak to peak for beam modulation at normal intensity.

GRATICULE

External; variable edge lighting. 10 x 10-division display area (3 1/8 x 3 1/8 inches). Vertical and horizontal center lines marked in 1/5 divisions.

DISPLAY FEATURES

Beam-position indicators show direction of CRT beam when off screen.

OTHER CHARACTERISTICS

AMPLITUDE CALIBRATOR

0.2 mV to 100 V squarewave, 18 calibrated steps (1-2-5 sequence), accurate within 3%, approx 1-kHz repetition rate.

POWER REQUIREMENTS

Wired for 115 V RMS $\pm 9\%$; transformer taps permit operation at 108, 115, 122, 216, 230, or 244 V ($\pm 9\%$ on each range); 50 to 60 Hz. 625 W maximum power consumption with 2 Type K Units. Can be factory wired for any of the above nominal voltages, if so indicated on order.

DIMENSIONS AND WEIGHTS

Height	17 in	43.2 cm
Width	12 15/16 in	32.9 cm
Depth	23 7/8 in	60.7 cm
Net weight	56 3/4 lb	25.8 kg
Domestic shipping weight	≈ 73 lb	≈ 33.2 kg
Export-packed weight	≈ 93 lb	≈ 42.3 kg

INCLUDED STANDARD ACCESSORIES

Two P6006 10X probes (010-0127-00); BNC-to-BNC 18-in patch cord (012-0087-00); BNC to-banana plug 18-in patch cord (012-0091-00); BNC-post jack (012-0092-00); 3 to 2-wire adapter (103-0013-00); 3-conductor power cord (161-0010-03); smoke-gray light filter (378-0567-00); phase-measurement graticule (331-0057-00); two instruction manuals (070-0270-00).



TYPE T TIME-BASE GENERATOR

OPTIONAL ACCESSORIES

Optional accessories increase measurement capability and provide added convenience. Cameras, probes, Scope-Mobile® Carts and other major accessories are completely described in the catalog accessory pages.

CAMERA

The standard C-12 camera satisfies most trace-recording requirements. For applications that might require a different viewing system, lens, or back, refer to camera descriptions or consult your field engineer, representative, or distributor. Standard C-12: f/1.9—1:0.85 lens, no-parallax viewing, Polaroid Land* Pack-Film back

Type 536 to C-12 Camera adapter, order 016-0226-00

PROBES

The standard 10X probes supplied with the instrument satisfy most measurement requirements; however, optional probes (recommended on plug-in unit pages) may be better suited for particular applications.

SCOPE-MOBILE® CART

Model 202-2: storage drawer, carrier for 2 plug-in units, 9-position tilt-lock oscilloscope tray

RACK-MOUNT ADAPTER

Consists of cradle to support the Type 536 in any standard 19-in relay rack, and mask to fit around the front panel. Requires 17 1/2-in panel height, order 040-0281-00

*Registered Trade-Mark Poloroid Corporation

Please refer to Terms and Shipment, General Information page.

TYPE 543B RM543B

DC-to-33 MHz OSCILLOSCOPES

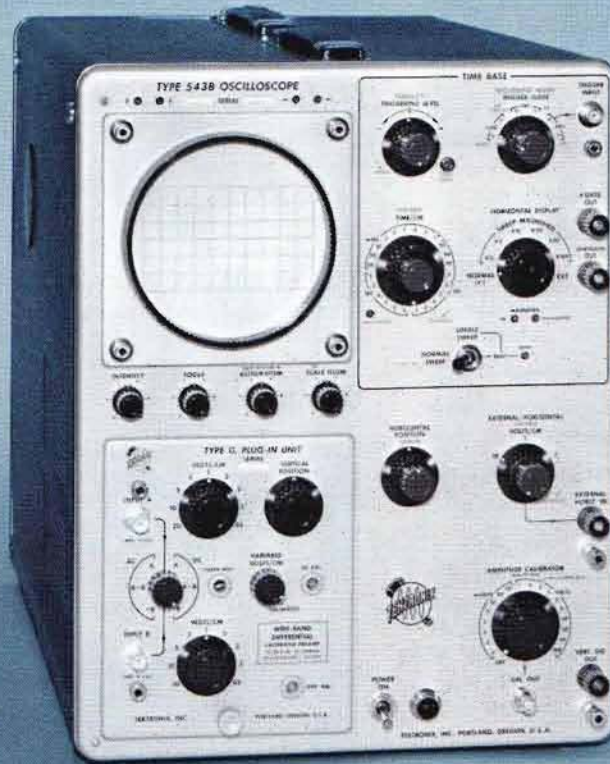

- **X100 SWEEP MAGNIFIER**
- **UNIFORM-FOCUS 6 x 10-CM DISPLAY**
- **ILLUMINATED PARALLAX-FREE GRATICULE**
- **FULL-BANDWIDTH TRIGGERING**
- **ACCEPTS MULTI-TRACE, DIFFERENTIAL, SAMPLING, AND SPECTRUM ANALYZER PLUG-IN UNITS**

The Type 543B and RM543B are versatile laboratory oscilloscopes designed for use with all Tektronix Letter-Series and 1-Series Plug-In Units.

A wide-range magnifier provides six steps of sweep magnification from X2 to X100.

CHARACTERISTIC SUMMARY

VERTICAL

Vertical deflection characteristics are extremely flexible through use of all 1-Series and Letter-Series Plug-In Units.

HORIZONTAL

CALIBRATED TIME BASE—0.1 μ s/cm to 5 s/cm.

SWEEP MAGNIFIER—X2, X5, X10, X20, X50, X100. Extends time base accurately to 20 ns/cm.

EXTERNAL INPUT—0.1 V/cm to 10 V/cm (calibrated), DC to 500 kHz.

CRT

DISPLAY AREA—6 x 10 cm.

ACCELERATING VOLTAGE—10 kV.

PHOSPHOR—P31

OTHER

AMPLITUDE CALIBRATOR—0.2 mV to 100 V, 1-kHz square-wave.

POWER REQUIREMENTS—108, 115, 122, 216, 230, or 244 V ($\pm 10\%$ on each range), 535 watts maximum.

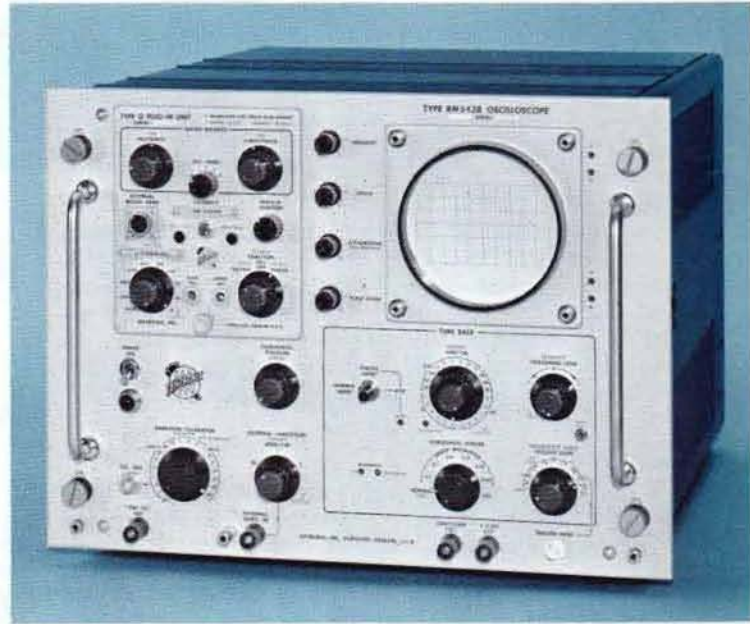

VERTICAL PLUG-IN UNITS			
PLUG-IN UNIT	MINIMUM DEFLECTION FACTOR	BANDWIDTH (-3 dB)	T _R
MULTIPLE TRACE			
1A1 Dual-Trace	50 mV/cm 5 mV/cm ≈500 μV/cm	DC to 33 MHz DC to 23 MHz 2 Hz to 14 MHz	11 ns 16 ns 25 ns
1A2 Dual-Trace	50 mV/cm	DC to 33 MHz	11 ns
CA Dual-Trace	50 mV/cm	DC to 24 MHz	15 ns
1A4 Four-Trace	10 mV/cm	DC to 33 MHz	11 ns
M Four-Trace	20 mV/cm	DC to 20 MHz	18 ns
SINGLE TRACE			
B	50 mV/cm 5 mV/cm	DC to 20 MHz 2 Hz to 12 MHz	18 ns 30 ns
H	5 mV/cm	DC to 15 MHz	24 ns
K	50 mV/cm	DC to 30 MHz	12 ns
L	50 mV/cm 5 mV/cm	DC to 30 MHz 3 Hz to 24 MHz	12 ns 15 ns
SPECIAL PURPOSE			
O Operational	50 mV/cm	DC to 25 MHz	14 ns
Q Strain Gage	10 μstrain/div	DC to 6 kHz	60 μs
DIFFERENTIAL			
1A5 Comparator	5 mV/cm 2 mV/cm 1 mV/cm	DC to 33 MHz DC to 31 MHz DC to 30 MHz	11 ns 12 ns 12 ns
1A6	1 mV/cm	DC to 2 MHz	0.18 μs
1A7A High-Gain	10 μV/cm	DC to 1 MHz Selectable	350 ns
D	1 mV/cm (to 50 mV/cm)	DC to 300 kHz (DC to 2 MHz)	0.18 μs
E	50 μV/cm (to 10 mV/cm)	0.06 Hz to 20 kHz (to 60 kHz) Selectable	6 μs
G	50 mV/cm	DC to 20 MHz	18 ns
W Comparator	1 mV/cm 50 mV/cm	DC to 8 MHz DC to 23 MHz	44 ns 16 ns
Z Comparator	50 mV/cm	DC to 13 MHz	27 ns
SPECTRUM ANALYZERS			
1L5	10 μV/cm	10 Hz to 1 MHz	
1L10	-100 dBm	1 MHz to 36 MHz	
1L20	-110 to -90 dBm	10 MHz to 4.2 GHz	
1L30	-105 to -75 dBm	925 MHz to 10.5 GHz	
WIDE-BAND SAMPLING			
1S1	2 mV/cm	DC to 1 GHz	350 ps
1S2 TDR	5 m _p /cm 5 mV/cm	140 ps system risetime DC to 3.9 GHz	90 ps

VERTICAL DEFLECTION

BANDWIDTH

DC to 33 MHz at 3-dB down, depending on plug-in unit. See chart.

RISETIME

11 ns, depending on plug-in unit. See chart.

DELAY LINE

Permits viewing leading edge of displayed waveform.

SIGNAL OUTPUT

Approx 1.2 V for each centimeter of displayed signal.

HORIZONTAL DEFLECTION

TIME BASE

0.1 μs/cm to 5 s/cm in 24 calibrated steps (1-2-5 sequence), accurate within 3%. Uncalibrated, continuously variable between steps and to approx 12 s/cm. Warning light indicates uncalibrated setting.

MAGNIFIER

X2, X5, X10, X20, X50 or X100 magnification. Magnified time base accurate within 5% up to 20 ns/cm. Warning light indicates if time base exceeds 20 ns/cm (uncalibrated).

OPERATING MODES

Normal, single sweep.

EXTERNAL INPUT

0.1, 1, and 10 V/cm, accurate within 5%. Uncalibrated, continuously variable between steps and to approx 100 V/cm. DC to ≥500 kHz at -3dB. 50-V maximum input (DC + peak AC) in most-sensitive position. Input RC approx 1 MΩ paralleled by approx 55 pF.

SIGNAL OUTPUTS

Gate (positive going from 0 to at least +20 V), sawtooth (positive going from 0 to at least +130 V).

TRIGGER

MODES

Automatic mode or manual level selection. Automatic operation is useful between approx 50 Hz and 10 MHz, minimizes trigger adjustments for signals of different amplitudes, shapes, and repetition rates. With no input (or input less than 50 Hz), automatic triggering occurs at an approx 40 Hz rate, providing a convenient reference trace.

TYPE **543B** **RM543B**

COUPLING

AC, DC or AC LF reject.

SOURCES

Internal (from oscilloscope vertical amplifier), external, or line. External trigger input RC approx $1\text{ M}\Omega$ (91 k Ω at AC LF reject) paralleled by approx 25 pF. 50-V maximum input (DC + peak AC).

REQUIREMENTS

0.2-cm deflection or 0.2-V external from 150 Hz to 10 MHz, increasing to 1-cm deflection or 1-V external at 30 MHz. Requirements increase below 30 kHz with AC low-frequency reject. DC coupling requires 0.6-cm deflection or 0.2-V external to 10 MHz. Automatic operation requires 0.5-cm deflection or 0.5-V external at 150 Hz, increased deflection to 10 MHz.

CRT

TEKTRONIX CRT

5-in metallized screen, helical post accelerating anode, 10-kV accelerating potential for bright displays. Spot diameter with intensity adjusted for typical ambient-light conditions (2 μA beam current) is nominally 9 mils at center screen, no more than 12 mils at either end of the horizontal axis. P31 phosphor normally supplied. Z-axis input is AC coupled to CRT cathode, requires 15 V peak to peak for beam modulation at normal intensity.

GRATICULE

Internal, parallax-free; variable edge lighting. 6 x 10-cm display area. Vertical and horizontal center lines marked in 2-mm divisions. Two additional horizontal lines for convenient risetime measurements.

DISPLAY FEATURES

Beam-position indicators show direction of CRT beam when off screen. Multi-trace blanking eliminates switching transients from display when multi-trace plug-in unit is operated in chopped mode.

OTHER CHARACTERISTICS

AMPLITUDE CALIBRATOR

0.2 mV to 100 V squarewave, 18 calibrated steps (1-2-5 sequence), accurate within 3%, approx 1-kHz repetition rate. Special output, useful in calibrating sampling plug-ins, provides $0.1\text{ V} \pm 3\%$ into 50 Ω .

POWER REQUIREMENTS

Wired for 115 V RMS $\pm 10\%$; transformer taps permit operation at 108, 115, 122, 216, 230, or 244 V ($\pm 10\%$ on each range); 50 to 60 Hz. 535 W maximum power consumption. Can be factory wired for any of the above nominal voltages, if so indicated on order.

CABINET MODEL DIMENSIONS AND WEIGHTS

Height	17 in	43.2 cm
Width	$12\frac{5}{16}$ in	32.9 cm
Depth	$23\frac{7}{8}$ in	60.7 cm
Net weight	$60\frac{1}{4}$ lb	27.4 kg
Domestic shipping weight	≈ 78 lb	≈ 35.5 kg
Export-packed weight	≈ 97 lb	≈ 44.1 kg

RACK MODEL DIMENSIONS AND WEIGHTS

Height	14 in	35.6 cm
Width	19 in	48.3 cm
Rack Depth	$22\frac{1}{16}$ in	57.6 cm
Net weight	81 lb	36.8 kg
Domestic shipping weight	≈ 106 lb	≈ 48.2 kg
Export-packed weight	≈ 130 lb	≈ 59.1 kg

RACK MOUNTING

Type RM543B withdraws from its cabinet on slide-out tracks, tilts and locks in 7 positions. Further mounting information on catalog instrument dimension page.

INCLUDED STANDARD ACCESSORIES

Two P6006 10X probes (010-0127-00); BNC-to-BNC 18-in 50- Ω cable (012-0076-00); BNC-to-BNC 18-in patch cord (012-0087-00); BNC-to-banana plug 18-in patch cord (012-0091-00); BNC post jack (012-0092-00); 3 to 2-wire adapter (103-0013-00); 3-conductor power cord (161-0010-03); smoke-gray light filter, installed (378-0567-00); clear CRT protection plate (387-0918-00); two instruction manuals (070-0429-00). Type RM543B also includes mounting hardware.

OPTIONAL ACCESSORIES

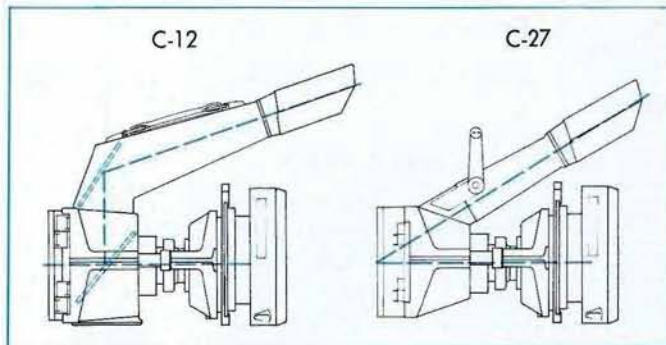

CAMERAS

C-12 has dichroic mirror for straight-on viewing and use of optional projected graticule, f/1.9—1:0.85 lens, Polaroid* Land Pack Film back accepts 3000-speed film

Type 543B to C-12 Camera adapter, order 016-0226-00

C-27 provides direct viewing and maximum transmission of light to film, f/1.9—1:0.85 lens, Polaroid Land Pack Film back accepts 3000-speed film

Type 543B to C-27 Camera adapter, order 016-0225-00

Polaroid Roll Film back accepts 10,000-speed film for increased writing speed, can be substituted at no additional cost in either camera. Order C-12R or C-27R. Optional lenses are also available.

PROBES

The standard 10X probes supplied with the instrument satisfy most measurement requirements; however, optional probes (recommended on plug-in unit pages) may be better suited for particular applications.

SCOPE-MOBILE® CART

Model 202-2: storage drawer, carrier for 2 plug-in units. 9-position tilt-lock oscilloscope tray

TV ACCESSORIES FOR GENERAL-PURPOSE OSCILLOSCOPES

In addition to the Tektronix line of television instruments, accessories are available for use with many Tektronix general-purpose oscilloscopes. A TV Sync Separator provides stable triggering for the display of composite video signals. A Video Staircase Differentiator allows the amplitude linearity of television systems and their components to be measured. See catalog accessory pages for additional information.

*Registered Trade-Mark Polaroid Corporation

Please refer to Terms and Shipment, General Information page.

DC-to-50 MHz OSCILLOSCOPES



- **X100 SWEEP MAGNIFIER**
- **UNIFORM-FOCUS 6 x 10-CM DISPLAY**
- **ILLUMINATED PARALLAX-FREE GRATICULE**
- **FULL-BANDWIDTH TRIGGERING**
- **ACCEPTS MULTI-TRACE, DIFFERENTIAL, SAMPLING, AND SPECTRUM ANALYZER PLUG-IN UNITS**

Type 544 and RM544 Oscilloscopes are versatile laboratory instruments designed for maximum performance with all Letter-Series and 1-Series Plug-In Units. Bandwidth extends from DC to 50 MHz.

A wide-range magnifier provides six steps of sweep magnification from X2 to X100.

CHARACTERISTIC SUMMARY

VERTICAL

Vertical deflection characteristics are extremely flexible through use of all 1-Series and Letter-Series Plug-In Units.

HORIZONTAL

CALIBRATED TIME BASE—0.1 μ s/cm to 5 s/cm.

SWEEP MAGNIFIER—X2, X5, X10, X20, X50, X100. Extends calibrated time base accurately to 10 ns/cm.

EXTERNAL INPUT—0.1 V/cm to 10 V/cm (calibrated). DC to 400 kHz.

CRT

DISPLAY AREA—6 x 10 cm.

ACCELERATING VOLTAGE—10 kV.

PHOSPHOR—P31

OTHER

AMPLITUDE CALIBRATOR—0.2 mV to 100 V (1 kHz square-wave), 100 V DC, 5 mA DC, 5 mA 1-kHz squarewave.

POWER REQUIREMENTS—108, 115, 122, 216, 230, or 244 V ($\pm 10\%$ on each range), typically 400 watts.

TYPE **544** **RM544**

VERTICAL PLUG-IN UNITS			
PLUG-IN UNIT	MINIMUM DEFLECTION FACTOR	BANDWIDTH (—3 dB)	T _R
MULTIPLE TRACE			
1A1 Dual-Trace	50 mV/cm	DC to 50 MHz	7 ns
	5 mV/cm	DC to 28 MHz	13 ns
	≈500 μV/cm	2 Hz to 15 MHz	24 ns
1A2 Dual-Trace	50 mV/cm	DC to 50 MHz	7 ns
CA Dual-Trace	50 mV/cm	DC to 24 MHz	15 ns
1A4 Four-Trace	10 mV/cm	DC to 50 MHz	7 ns
SINGLE TRACE			
B	50 mV/cm	DC to 20 MHz	18 ns
	5 mV/cm	2 Hz to 12 MHz	30 ns
H	5 mV/cm	DC to 15 MHz	24 ns
K	50 mV/cm	DC to 30 MHz	12 ns
L	50 mV/cm	DC to 30 MHz	12 ns
	5 mV/cm	3 Hz to 24 MHz	15 ns
SPECIAL PURPOSE			
O Operational	50 mV/cm	DC to 25 MHz	14 ns
Q Strain Gage	10 μstrain/div	DC to 6 kHz	60 μs
DIFFERENTIAL			
1A5 Comparator	5 mV/cm	DC to 50 MHz	7 ns
	2 mV/cm	DC to 45 MHz	8 ns
	1 mV/cm	DC to 40 MHz	9 ns
1A6	1 mV/cm	DC to 2 MHz	0.18 μs
1A7A High-Gain	10 μV/cm	DC to 1 MHz Selectable	350 ns
D	1 mV/cm (to 50 mV/cm)	DC to 300 kHz (DC to 2 MHz)	0.18 μs
E	50 μV/cm (to 10 mV/cm)	0.06 Hz to 20 kHz (to 60 kHz) Selectable	6 μs
G	50 mV/cm	DC to 20 MHz	18 ns
W Comparator	1 mV/cm	DC to 8 MHz	44 ns
	50 mV/cm	DC to 23 MHz	16 ns
Z Comparator	50 mV/cm	DC to 13 MHz	27 ns
SPECTRUM ANALYZERS			
1L5	10 μV/cm	10 Hz to 1 MHz	
1L10	—100 dBm	1 MHz to 36 MHz	
1L20	—110 to —90 dBm	10 MHz to 4.2 GHz	
1L30	—105 to —75 dBm	925 MHz to 10.5 GHz	
WIDE-BAND SAMPLING			
1S1	2 mV/cm	DC to 1 GHz	350 ps
1S2 TDR	5 m _p /cm	140 ps system risetime	
	5 mV/cm	DC to 3.9 GHz	90 ps

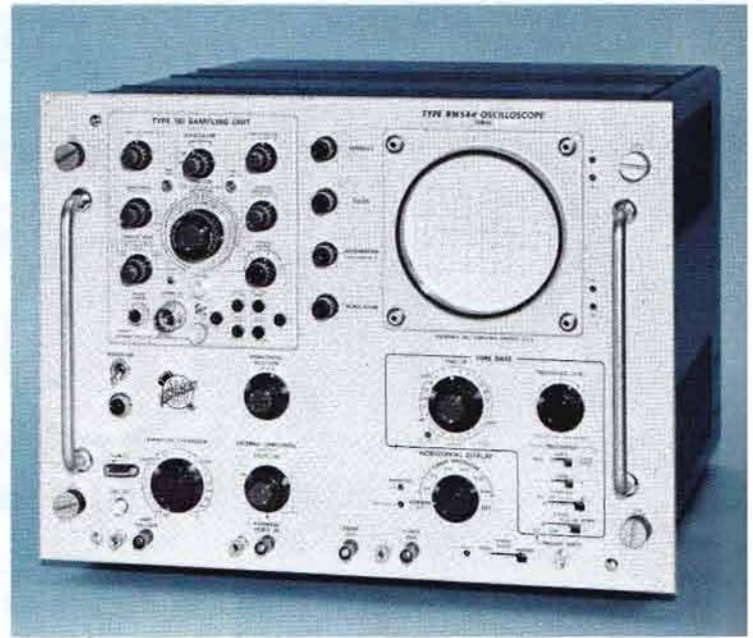

VERTICAL DEFLECTION

BANDWIDTH

DC to 50 MHz at 3-dB down, depending on plug-in unit. See chart.

RISETIME

7 ns, depending on plug-in unit. See chart.

DELAY LINE

Permits viewing leading edge of display waveform.

SIGNAL OUTPUT

20 ns risetime, at least 0.3 V for each centimeter of displayed signal.

HORIZONTAL DEFLECTION

TIME BASE

0.1 μs/cm to 5 s/cm in 24 calibrated steps (1-2-5 sequence), accurate within 2%. Uncalibrated, continuously variable between steps and to approx 12 s/cm. Warning light indicates uncalibrated setting.

MAGNIFIER

X2, X5, X10, X20, X50 or X100 magnification. Magnified time base accurate within 5% up to 10 ns/cm. Warning light indicates if time base exceeds 10 ns/cm (uncalibrated).

OPERATING MODES

Normal, single sweep. Single sweep reset at front panel, or with ≥ +20-V pulse with < 0.5-μs risetime, through rear-panel connector.

EXTERNAL INPUT

0.1, 1, and 10 V/cm, accurate within 5%. Uncalibrated, continuously variable between steps and to approx 100 V/cm. DC to ≥ 400 kHz at —3 dB. 50-V maximum input (DC + peak AC) in most sensitive position. Input RC approx 1 MΩ paralleled by approx 55 pF.

SIGNAL OUTPUTS

Gate (positive-going from 0 to at least +20 V) sawtooth (positive-going from 0 to at least +90 V).

TRIGGER

MODES

Manual level selection with triggered or automatic operation. Automatic operation provides a convenient reference trace with no trigger-signal input, or repetition rates less than 20 Hz. Reference trace is bright throughout the full time-base range.

COUPLING

AC, DC, or AC LF reject.

SOURCES

Internal (from oscilloscope vertical amplifier or direct from a single channel of Type 1A1, 1A2, or 1A4 Plug-In Units), external, or line. 30 V maximum external input (DC + peak AC). External trigger input RC approx 1.1 M Ω paralleled by approx 30 pF.

REQUIREMENTS

0.2-cm deflection or 0.2-V external at 1 kHz, increasing to 1-cm deflection or 0.2-V external at 50 MHz. Requirements increase below 2 kHz with AC low-frequency reject. DC coupling requires 0.5-cm deflection or 0.2-V external at DC to 50 MHz. ± 2 -V or ± 20 -V trigger level selection.

CRT

TEKTRONIX CRT

5-in metalized screen, helical post accelerating anode, 10-kV accelerating potential for bright displays. Spot diameter with intensity adjusted for typical ambient-light conditions (2- μ A beam current) is nominally 9 mils at center screen, no more than 12 mils at either end of the horizontal axis. P31 phosphor normally supplied. Z-axis input is AC coupled to CRT cathode, requires 15 V peak to peak for beam modulation at normal intensity.

GRATICULE

Internal, parallax-free; variable edge lighting. 6 x 10-cm display area. Vertical and horizontal center lines marked in 2-mm divisions. Two additional horizontal lines for convenient risetime measurements.

DISPLAY FEATURES

Beam-position indicators show direction of CRT beam when off screen. Multi-trace blanking eliminates switching transients from display when multi-trace plug-in unit is operated in chopped mode.

OTHER CHARACTERISTICS

AMPLITUDE CALIBRATOR

0.2 mV to 100 V squarewave, 18 calibrated steps (1-2-5 sequence), accurate within 3%, approx 1-kHz repetition rate. 50- Ω source resistance from 0.2 mV to 0.2 V. 0.6- μ s risetime from 0.2 mV to 5 V; 1- μ s from 10 V to 100 V. 100-V DC reference output also provided. Front-panel current loop for 5 mA, $\pm 3\%$, squarewave or DC.

POWER REQUIREMENTS

Wired for 115 V RMS $\pm 10\%$; transformer taps permit operation at 108, 115, 122, 216, 230, or 244 V ($\pm 10\%$ on each range); 50 to 60 Hz. 400 W maximum power consumption. Can be factory wired for any of the above nominal voltages, if so indicated on order.

CABINET MODEL DIMENSIONS AND WEIGHTS

Height	17 in	43.2 cm
Width	12 ⁵ / ₁₆ in	32.9 cm
Depth	23 ⁷ / ₈ in	60.7 cm
Net weight	61 lb	27.8 kg
Domestic shipping weight	≈ 80 lb	≈ 36.4 kg
Export-packed weight	≈ 97 lb	≈ 44.1 kg

RACK MODEL DIMENSIONS AND WEIGHTS

Height	14 in	35.6 cm
Width	19 in	48.3 cm
Rack depth	22 ¹ / ₁₆ in	57.6 cm
Net weight	82 ¹ / ₄ lb	37.4 kg
Domestic shipping weight	≈ 106 lb	≈ 48.2 kg
Export-packed weight	≈ 130 lb	≈ 59.1 kg

RACK MOUNTING

Type RM544 withdraws from its cabinet on slide-out tracks, tilts and locks in 7 positions. Further mounting information on catalog instrument dimension page.

INCLUDED STANDARD ACCESSORIES

Two P6008 10X probes (010-0129-00), two BNC-to-BNC 18-in patch cords (012-0087-00); BNC-to-banana plug 18-in patch cord (012-0091-00), BNC post jack (012-0092-00); 3 to 2-wire adapter (103-0013-00); 3-conductor power cord (161-0010-03); smoke-gray light filter, installed (378-0567-00); clear CRT protector plate (387-0918-00); two instruction manuals (070-0418-00). Type RM544 also includes mounting hardware.

OPTIONAL ACCESSORIES

CAMERAS

C-12 has dichroic mirror for straight-on viewing and use of optional projected graticule, f/1.9—1:0.85 lens, Polaroid* Land Pack Film back accepts 3000-speed film

Type 544 to C-12 Camera adapter, order 016-0226-00

C-27 provides direct viewing and maximum transmission of light to film, f/1.9—1:0.85 lens, Polaroid Land Pack Film back accepts 3000-speed film

Type 544 to C-27 Camera adapter, order 016-0225-00

Polaroid Roll Film back accepts 10,000-speed film for increased writing speed, can be substituted at no additional cost in either camera. Order C-12R or C-27R. Optional lenses are also available.

PROBES

The standard 10X probes supplied with the instrument satisfy most measurement requirements; however, optional probes (recommended on plug-in unit pages) may be better suited for particular applications.

SCOPE-MOBILE® CART

Model 202-2: storage drawer, carrier for 2 plug-in units, 9-position tilt-lock oscilloscope tray

TV ACCESSORIES FOR GENERAL-PURPOSE OSCILLOSCOPES

In addition to the Tektronix line of television instruments, accessories are available for use with many Tektronix general-purpose oscilloscopes. A TV Sync Separator provides stable triggering for the display of composite video signals. A Video Staircase Differentiator allows the amplitude linearity of television systems and their components to be measured. See the catalog accessory pages for additional information.

*Registered Trade-Mark Polaroid Corporation

TYPE 545B RM545B

DC-to-33 MHz OSCILLOSCOPES

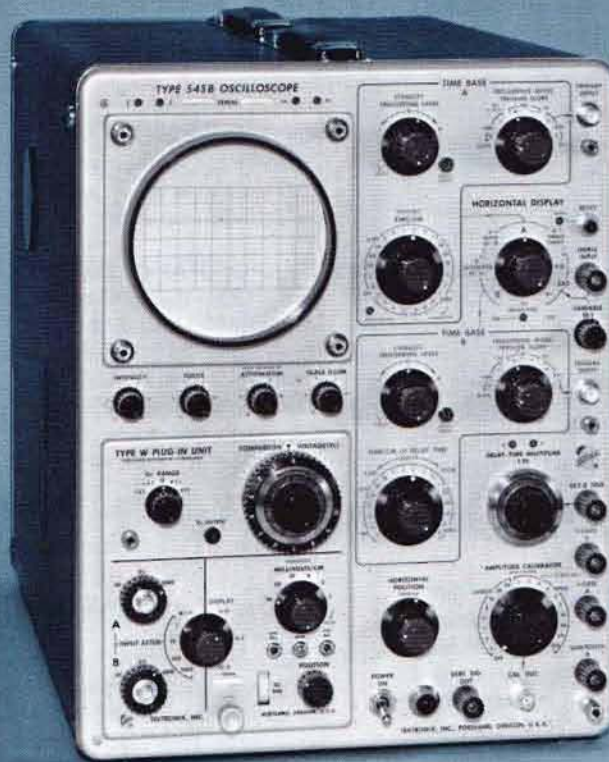

- **CALIBRATED SWEEP DELAY**
- **UNIFORM-FOCUS 6 x 10-CM DISPLAY**
- **ILLUMINATED PARALLAX-FREE GRATICULE**
- **FULL-BANDWIDTH TRIGGERING**
- **ACCEPTS MULTI-TRACE, DIFFERENTIAL, SAMPLING, AND SPECTRUM ANALYZER PLUG-IN UNITS**

The Type 545B and RM545B are versatile laboratory oscilloscopes designed for use with all Tektronix Letter-Series and 1-Series Plug-In Units.

Two separate time-base generators can be used in delayed-sweep operation for highly-accurate time measurements.

CHARACTERISTIC SUMMARY

VERTICAL

Vertical deflection characteristics are extremely flexible through use of all 1-Series and Letter-Series Plug-In Units.

HORIZONTAL

CALIBRATED TIME BASE—0.1 $\mu\text{s}/\text{cm}$ to 5 s/cm. Time Base B 2 $\mu\text{s}/\text{cm}$ to 1 s/cm.

X5 MAGNIFIER—Extends time base to 20 ns/cm.

CALIBRATED SWEEP DELAY—2 μs to 10 s.

EXTERNAL INPUT—0.2 V/cm, DC to 350 kHz.

CRT

DISPLAY AREA—6 x 10 cm.

ACCELERATING VOLTAGE—10 kV.

PHOSPHOR—P31

OTHER

AMPLITUDE CALIBRATOR—0.2 mV to 100 V, 1-kHz square-wave.

POWER REQUIREMENTS—108, 115, 122, 216, 230, or 244 V ($\pm 10\%$ on each range), 585 watts maximum.

VERTICAL DEFLECTION

BANDWIDTH

DC to 33 MHz at 3-dB down, depending on plug-in unit.
See chart.

RISETIME

11 ns, depending on plug-in unit. See chart.

DELAY LINE

Permits viewing leading edge of displayed waveform.

SIGNAL OUTPUT

Approx 1.2 V for each centimeter of displayed signal.

VERTICAL PLUG-IN UNITS	MINIMUM DEFLECTION FACTOR	BANDWIDTH (—3 dB)	T _R
MULTIPLE TRACE			
1A1 Dual-Trace	50 mV/cm 5 mV/cm ≈500 μV/cm	DC to 33 MHz DC to 23 MHz 2 Hz to 14 MHz	11 ns 16 ns 25 ns
1A2 Dual-Trace	50 mV/cm	DC to 33 MHz	11 ns
CA Dual-Trace	50 mV/cm	DC to 24 MHz	15 ns
1A4 Four-Trace	10 mV/cm	DC to 33 MHz	11 ns
M Four-Trace	20 mV/cm	DC to 20 MHz	18 ns
SINGLE TRACE			
B	50 mV/cm 5 mV/cm	DC to 20 MHz 2 Hz to 12 MHz	18 ns 30 ns
H	5 mV/cm	DC to 15 MHz	24 ns
K	50 mV/cm	DC to 30 MHz	12 ns
L	50 mV/cm 5 mV/cm	DC to 30 MHz 3 Hz to 24 MHz	12 ns 15 ns
SPECIAL PURPOSE			
O Operational	50 mV/cm	DC to 25 MHz	14 ns
Q Strain Gage	10 μstrain/div	DC to 6 kHz	60 μs
DIFFERENTIAL			
1A5 Comparator	5 mV/cm 2 mV/cm 1 mV/cm	DC to 33 MHz DC to 31 MHz DC to 30 MHz	11 ns 12 ns 12 ns
1A6	1 mV/cm	DC to 2 MHz	0.18 μs
1A7A High-Gain	10 μV/cm	DC to 1 MHz	350 ns
D	1 mV/cm (to 50 mV/cm)	DC to 300 kHz (DC to 2 MHz)	0.18 μs
E	50 μV/cm (to 10 mV/cm)	0.06 Hz to 20 kHz (to 60 kHz)	6 μs
G	50 mV/cm	DC to 20 MHz	18 ns
W Comparator	1 mV/cm 50 mV/cm	DC to 8 MHz DC to 23 MHz	44 ns 16 ns
Z Comparator	50 mV/cm	DC to 13 MHz	27 ns
SPECTRUM ANALYZERS			
1L5	10 μV/cm	10 Hz to 1 MHz	
1L10	—100 dBm	1 MHz to 36 MHz	
1L20	—110 to —90 dBm	10 MHz to 4.2 GHz	
1L30	—105 to —75 dBm	925 MHz to 10.5 GHz	
WIDE-BAND SAMPLING			
1S1	2 mV/cm	DC to 1 GHz	350 ps
1S2 TDR	5 mV/cm	140 ps system risetime	
	5 mV/cm	DC to 3.9 GHz	90 ps



HORIZONTAL DEFLECTION

TIME BASE A

0.1 μs/cm to 5 s/cm in 24 calibrated steps (1-2-5 sequence), accurate within 3%. Uncalibrated, continuously variable between steps and to approx 12.5 s/cm. Warning light indicates uncalibrated setting.

TIME BASE B

2 μs/cm to 1 s/cm in 18 calibrated steps (1-2-5 sequence), accurate within 3%. Sweep length continuously variable from 4 to 10 cm, allowing use of Time Base B as a repetition-rate generator from 0.1 Hz to 40 kHz.

X5 MAGNIFIER

Operates over full time base, increases fastest Time Base A rate to 20 ns/cm, and the fastest Time Base B rate to 0.4 μs/cm. Magnified time base accurate within 5%.

DELAY TIME

2 μs to 10 s, continuously variable and calibrated, accurate within 1% of indicated delay ±2 minor dial divisions (add processing time of approx 200 ns at fast sweep rates). Incremental delay-time accurate within 1% ±4 minor dial divisions. Short-term jitter ≤1/20,000 of total Time Base B delay time.

DELAY MODES

Depending on the setting of the Delayed Sweep stability control, the Delayed Sweep can start immediately at end of delay time, or be triggerable at end of delay time (for jitter-free displays).

OPERATING MODES

Time Base A—Normal, single sweep, delayed by B.
Time Base B—Normal, intensified by A.

EXTERNAL INPUT

Fixed steps of approx 0.2 V/cm and 2 V/cm, continuously variable between steps and to approx 20 V/cm, DC to ≥350 kHz at —3 dB. 50-V maximum input (DC + peak AC). Input RC approx 1 MΩ paralleled by approx 45 pF.

SIGNAL OUTPUTS

Gates from both time bases (positive going from 0 to at least +20 V), sawtooth from Time Base A (positive going from 0 to at least +130 V), and a delayed trigger pulse (positive going from 0 to at least +5 V).

TYPE **545B** **RM545B**

TRIGGER

MODES

Automatic mode or manual level selection. Automatic operation is useful between approx 50 Hz and 10 MHz, minimizes trigger adjustments for signals of different amplitudes, shapes, and repetition rates. With no input (or input less than 50 Hz), automatic triggering occurs at an approx 40-Hz rate, providing a convenient reference trace.

COUPLING

AC or DC; AC LF reject on Time Base A.

SOURCES

Internal (from oscilloscope vertical amplifier), external, or line. 50-V maximum external input (DC + peak AC). External trigger input RC approx 1 M Ω (91 k Ω at AC LF reject) paralleled by approx 25 pF for Time Base A, approx 1 M Ω paralleled by approx 47 pF for Time Base B.

TIME BASE A REQUIREMENTS

0.2-cm deflection or 0.2-V external from 150 Hz to 10 MHz, increasing to 1-cm deflection or 1-V external at 30 MHz. Requirements increase below 30 kHz with AC low-frequency reject. DC coupling requires 0.6-cm deflection or 0.2-V external to 10 MHz. Automatic operation requires 0.5-cm deflection or 0.5-V external at 150 Hz, increased deflection to 10 MHz.

TIME BASE B REQUIREMENTS

0.2-cm deflection or 0.2-V external at 300 Hz to 5 MHz, increasing to 1-cm deflection or 1-V external at 10 MHz. Requirements increase below 300 Hz with AC coupling. DC coupling requires 0.6-cm deflection or 0.2-V external to 5 MHz. Automatic operation requires 0.5-cm deflection or 0.5-V external at 300 Hz, will trigger from 50 Hz to 5 MHz with increased signal.

CRT

TEKTRONIX CRT

5-in metallized screen, helical post accelerating anode. 10-kV accelerating potential for bright displays. Spot diameter with intensity adjusted for typical ambient-light conditions (2- μ A beam current) is nominally 9 mils at center screen, no more than 12 mils at either end of the horizontal axis. P31 phosphor normally supplied. Z-axis input is AC coupled to CRT cathode, requires 15 V peak to peak for beam modulation at normal intensity.

GRATICULE

Internal, parallax-free; variable edge lighting. 6 x 10-cm display area. Vertical and horizontal center lines marked in 2-mm divisions. Two additional horizontal lines for convenient risetime measurements.

DISPLAY FEATURES

Beam-position indicators show direction of CRT beam when off screen. Multi-trace blanking eliminates switching transients from display when multi-trace plug-in unit is operated in chopped mode.

OTHER CHARACTERISTICS

AMPLITUDE CALIBRATOR

0.2 mV to 100 V squarewave, 18 calibrated steps (1-2-5 sequence), accurate within 3%, approx 1-kHz repetition rate. Special output, useful in calibrating sampling plug-ins, provides 0.1 V \pm 3% into 50 Ω .

POWER REQUIREMENTS

Wired for 115 V RMS \pm 10%; transformer taps permit operation at 108, 115, 122, 216, 230, or 244 V (\pm 10% on each range); 50 to 60 Hz. 585-W maximum power consumption. Can be factory wired for any of the above nominal voltages, if so specified on order.

CABINET MODEL DIMENSIONS AND WEIGHTS

Height	17 in	43.2 cm
Width	12 ¹⁵ / ₁₆ in	32.9 cm
Depth	23 ⁷ / ₈ in	60.7 cm
Net weight	64 lb	29.1 kg
Domestic shipping weight	\approx 82 lb	\approx 37.3 kg
Export-packed weight	\approx 101 lb	\approx 45.9 kg

RACK MODEL DIMENSIONS AND WEIGHTS

Height	14 in	35.6 cm
Width	19 in	48.3 cm
Rack depth	22 ¹¹ / ₁₆ in	57.6 cm
Net weight	85 lb	38.6 kg
Domestic shipping weight	\approx 111 lb	\approx 50.5 kg
Export-packed weight	\approx 130 lb	\approx 59.1 kg

RACK MOUNTING

Type RM545B withdraws from its cabinet on slide-out tracks, tilts and locks in 7 positions. Further mounting information on catalog instrument dimension page.

INCLUDED STANDARD ACCESSORIES

Two P6006 10X probes (010-0127-00); BNC-to-BNC 18-in 50- Ω cable (012-0076-00); two BNC-to-BNC 18-in patch cords (012-0087-00); BNC-to-banana plug 18-in patch cord (012-0091-00); BNC post jack (012-0092-00), 3 to 2-wire adapter (103-0013-00); 3-conductor power cord (161-0010-03); smoke-gray light filter, installed (378-0567-00); clear CRT protector plate (387-0918-00); two instruction manuals (070-0428-00). Type RM545B also includes mounting hardware.

OPTIONAL ACCESSORIES

CAMERAS

C-12 has dichroic mirror for straight-on viewing and use of optional projected graticule, f/1.9—1:0.85 lens, Polaroid* Land Pack Film back accepts 3000-speed film

Type 545B to C-12 Camera adapter, order 016-0226-00

C-27 provides direct viewing and maximum transmission of light to film, f/1.9—1:0.85 lens, Polaroid Land Pack Film back accepts 3000-speed film

Type 545B to C-27 Camera adapter, order 016-0225-00

Polaroid Roll Film back accepts 10,000-speed film for increased writing speed, can be substituted at no additional cost in either camera. Order C-12R or C-27R. Optional lenses are also available.

PROBES

The standard 10X probes supplied with the instrument satisfy most measurement requirements; however, optional probes (recommended on plug-in unit pages) may be better suited for particular applications.

SCOPE-MOBILE® CART

Model 202-2: storage drawer, carrier for 2 plug-in units, 9-position tilt-lock oscilloscope tray

TV ACCESSORIES FOR GENERAL-PURPOSE OSCILLOSCOPES

In addition to the Tektronix line of television instruments, accessories are available for use with many Tektronix general-purpose oscilloscopes. A TV Sync Separator provides stable triggering for the display of composite video signals. A Video Staircase Differentiator allows the amplitude linearity of television systems and their components to be measured.

*Registered Trade-Mark Polaroid Corporation

Please refer to Terms and Shipment, General Information page.

DC-to-50 MHz OSCILLOSCOPES



- **CALIBRATED SWEEP DELAY**
- **UNIFORM-FOCUS 6 x 10-CM DISPLAY**
- **ILLUMINATED PARALLAX-FREE GRATICULE**
- **FULL-BANDWIDTH TRIGGERING**
- **ACCEPTS MULTI-TRACE, DIFFERENTIAL, SAMPLING, AND SPECTRUM ANALYZER PLUG-IN UNITS**

Type 546 and RM546 Oscilloscopes are versatile laboratory instruments designed for maximum performance with all Letter-Series and 1-Series Plug-In Units. Bandwidth extends from DC to 50 MHz.

The two time-base generators can be used in delayed sweep operations for highly accurate time measurements.

CHARACTERISTIC SUMMARY

VERTICAL

Vertical deflection characteristics are extremely flexible through use of all 1-Series and Letter-Series Plug-In Units.

HORIZONTAL

CALIBRATED TIME BASE—0.1 μ s/cm to 5 s/cm.

SWEEP MAGNIFIER—X2, X5, or X10 extends calibrated time base to 10 ns/cm.

CALIBRATED SWEEP DELAY—0.1 μ s to 50 s.

EXTERNAL INPUT—0.1 V/cm to 1 V/cm deflection factor, DC to 500 kHz.

CRT

DISPLAY AREA—6 x 10 cm.

ACCELERATING VOLTAGE—10 kV.

PHOSPHOR—P31

OTHER

AMPLITUDE CALIBRATOR—0.2 mV to 100 V, 1-kHz square-wave, 100 V DC, 5 mA DC, 5 mA 1-kHz squarewave.

POWER REQUIREMENT—108, 115, 122, 216, 230, or 244 V ($\pm 10\%$ on each range), typically 510 watts.

TYPE **546** **RM546**

VERTICAL PLUG-IN UNITS			
PLUG-IN UNIT	MINIMUM DEFLECTION FACTOR	BANDWIDTH (—3 dB)	T _R
MULTIPLE TRACE			
1A1 Dual-Trace	50 mV/cm 5 mV/cm ≈500 μV/cm	DC to 50 MHz DC to 28 MHz 2 Hz to 15 MHz	7 ns 13 ns 24 ns
1A2 Dual-Trace	50 mV/cm	DC to 50 MHz	7 ns
CA Dual-Trace	50 mV/cm	DC to 24 MHz	15 ns
1A4 Four-Trace	10 mV/cm	DC to 50 MHz	7 ns
M Four-Trace	20 mV/cm	DC to 20 MHz	18 ns
SINGLE TRACE			
B	50 mV/cm 5 mV/cm	DC to 20 MHz 2 Hz to 12 MHz	18 ns 30 ns
H	5 mV/cm	DC to 15 MHz	24 ns
K	50 mV/cm	DC to 30 MHz	12 ns
L	50 mV/cm 5 mV/cm	DC to 30 MHz 3 Hz to 24 MHz	12 ns 15 ns
SPECIAL PURPOSE			
O Operational	50 mV/cm	DC to 25 MHz	14 ns
Q Strain Gage	10 μstrain/div	DC to 6 kHz	60 μs
DIFFERENTIAL			
1A5 Comparator	5 mV/cm 2 mV/cm 1 mV/cm	DC to 50 MHz DC to 45 MHz DC to 40 MHz	7 ns 8 ns 9 ns
1A6	1 mV/cm	DC to 2 MHz	0.18 μs
1A7A High-Gain	10 μV/cm	DC to 1 MHz Selectable	350 ns
D	1 mV/cm (to 50 mV/cm)	DC to 300 kHz (DC to 2 MHz)	0.18 μs
E	50 μV/cm (to 10 mV/cm)	0.06 Hz to 20 kHz (to 60 kHz) Selectable	6 μs
G	50 mV/cm	DC to 20 MHz	18 ns
W Comparator	1 mV/cm 50 mV/cm	DC to 8 MHz DC to 23 MHz	44 ns 16 ns
Z Comparator	50 mV/cm	DC to 13 MHz	27 ns
SPECTRUM ANALYZERS			
1L5	10 μV/cm	10 Hz to 1 MHz	
1L10	—100 dBm	1 MHz to 36 MHz	
1L20	—110 to —90 dBm	10 MHz to 4.2 GHz	
1L30	—105 to —75 dBm	925 MHz to 10.5 GHz	
WIDE-BAND SAMPLING			
1S1	2 mV/cm	DC to 1 GHz	350 ps
1S2 TDR	5 mρ/cm 5 mV/cm	140 ps system risetime DC to 3.9 GHz	90 ps

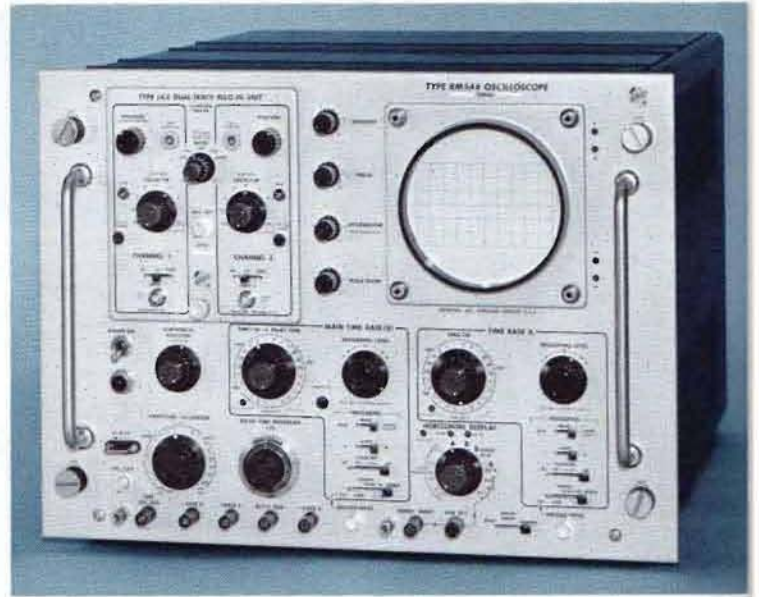

VERTICAL DEFLECTION

BANDWIDTH

DC to 50 MHz at 3-dB down, depending on plug-in unit. See chart.

RISETIME

7 ns, depending on plug-in unit. See chart.

DELAY LINE

Permits viewing leading edge of displayed waveform.

SIGNAL OUTPUT

20-ns risetime, at least 0.3 V for each centimeter of displayed signal.

HORIZONTAL DEFLECTION

TIME BASE A AND B

0.1 μs/cm to 5 s/cm in 24 calibrated steps (1-2-5 sequence), accurate within 2%. Uncalibrated, continuously variable between steps and to approx 12 s/cm. Warning light indicates uncalibrated setting.

MAGNIFIER

X2, X5, or X10 magnification over full time base, increases fastest rate to 10 ns/cm. Magnified time base accurate within 5%.

DELAY TIME

0.1 μs to 50 s, continuously variable and calibrated, accurate within 1% of indicated delay ±2 minor dial divisions from 50 μs to 50 s. At delay times less than 50 μs add ≤100 ns for fixed delay. Incremental delay-time accurate within 1% ±4 minor dial divisions, from 1 μs to 50 s, ±10 minor divisions at 0.1, 0.2 and 0.5 μs. Uncalibrated delay to approx 120 s. Short-term jitter ≤1/20,000 of total Time Base B delay time.

DELAY MODES

Delayed sweep starts immediately at end of delay time, or is triggerable at end of delay time (for jitter-free displays).

DISPLAY MODES

Time Base A—Normal, delayed by B, single sweep of both modes. Time Base B—Normal, intensified by A, single sweep of both modes. Single sweep reset at front panel or with ≥+20-V pulse with <0.5-μs risetime, through rear-panel connector.

EXTERNAL INPUT

Fixed steps of approx 0.1 V/cm and 1 V/cm, continuously variable between steps and to approx 10 V/cm, DC to ≥ 400 kHz at -3 dB. 50-V maximum input (DC + peak AC) in most sensitive position. Input RC approx 1 M Ω paralleled by approx 55 pF.

SIGNAL OUTPUTS

Gates from both time bases (positive going from 0 to at least +20 V), sawtooth from Time Base A (positive going from approx 0 to at least +90 V), and a delayed trigger pulse (positive going from 0 to at least +10 V).

TRIGGER

2 identical systems

MODES

Manual level selection with triggered or automatic operation. Automatic operation provides a convenient reference trace with no trigger-signal input, or repetition rates less than 20 Hz. Reference trace is bright throughout the full time-base range.

COUPLING

AC, DC, or AC LF reject.

SOURCES

Internal (from oscilloscope vertical amplifier or direct from a single channel of Type 1A1, 1A2 or 1A4 Plug-In Units), external, or line. 30-V maximum external input (DC + peak AC). External trigger input RC approx 1.1 M Ω paralleled by approx 30 pF.

REQUIREMENTS

0.2-cm deflection or 0.2-V external at 1 kHz, increasing to 1-cm deflection or 0.2-V external at 50 MHz. Requirements increase below 2 kHz with AC low-frequency reject. DC coupling requires 0.5-cm deflection or 0.2-V external at DC to 50 MHz. ± 2 -V or ± 20 -V trigger level selection.

CRT

TEKTRONIX CRT

5-in metallized screen, helical post accelerating anode, 10-kV accelerating potential for bright displays. Spot diameter with intensity adjusted for typical ambient-light conditions (2- μ A beam current) is nominally 9 mils at center screen, no more than 12 mils at either end of the horizontal axis. P31 phosphor normally supplied. Z-axis input is AC coupled to CRT cathode, requires 15 V peak to peak or beam modulation at normal intensity.

GRATICULE

Internal, parallax-free; variable edge lighting. 6 x 10-cm display area. Vertical and horizontal center lines marked in 2-mm divisions. Two additional horizontal lines for convenient risetime measurements.

DISPLAY FEATURES

Beam-position indicators show direction of CRT beam when off screen. Multi-trace blanking eliminates switching transients from display when multi-trace plug-in unit is operated in chopped mode.

OTHER CHARACTERISTICS

AMPLITUDE CALIBRATOR

0.2 mV to 100 V squarewave, 18 calibrated steps (1-2-5 sequence), accurate within 3%, approx 1-kHz repetition rate. 50- Ω source resistance from 0.2 mV to 0.2 V. 0.6- μ s rise-time from 0.2 mV to 5 V; 1- μ s from 10 V to 100 V. 100-V DC reference output also provided. Front-panel current loop for 5 mA $\pm 3\%$, squarewave or DC.

POWER REQUIREMENTS

Wired for 115 V RMS $\pm 10\%$; transformer taps permit operation at 108, 115, 122, 216, 230, or 244 V ($\pm 10\%$ on each range); 50 to 60 Hz. 510 W maximum power consumption. Can be factory wired for any of the above nominal voltages, if so indicated on order.

CABINET MODEL DIMENSIONS AND WEIGHTS

Height	17 in	43.2 cm
Width	12 ⁵ / ₁₆ in	32.9 cm
Depth	23 ⁷ / ₈ in	60.7 cm
Net weight	65 ¹ / ₄ lb	29.7 kg
Domestic shipping weight	≈ 84 lb	≈ 38.2 kg
Export-packed weight	≈ 102 lb	≈ 46.4 kg

RACK MODEL DIMENSIONS AND WEIGHTS

Height	14 in	35.6 cm
Width	19 in	48.3 cm
Rack depth	22 ¹ / ₁₆ in	57.6 cm
Net weight	85 ¹ / ₂ lb	38.9 kg
Domestic shipping weight	≈ 112 lb	≈ 51.0 kg
Export-packed weight	≈ 136 lb	≈ 61.8 kg

RACK MOUNTING

Type RM546 withdraws from its cabinet on slide-out tracks, tilts and locks in 7 positions. Further mounting information on catalog instrument dimension page.

INCLUDED STANDARD ACCESSORIES

Two P6008 10X probes (010-0129-00); three BNC-to-BNC 18-in patch cords (012-0087-00); BNC-to-banana plug 18-in patch cord (012-0091-00), BNC post jack (012-0092-00). 3 to 2-wire adapter (103-0013-00); 3-conductor power cord (161-0010-03); smoke-gray light filter, installed (378-0567-00); clear CRT protector plate (387-0918-00); two instruction manuals (070-0367-00). Type RM546 also includes mounting hardware.

OPTIONAL ACCESSORIES

CAMERAS

C-12 has dichroic mirror for straight-on viewing and use of optional projected graticule, f/1.9—1:0.85 lens, Polaroid* Land Pack Film back accepts 3000-speed film

Type 546 to C-12 Camera adapter, order 016-0226-00

C-27 provides direct viewing and maximum transmission of light to film, f/1.9—1:0.85 lens, Polaroid Land Pack Film back accepts 3000-speed film

Type 546 to C-27 Camera adapter, order 016-0225-00

Polaroid Roll Film back accepts 10,000-speed film for increased writing speed, can be substituted at no additional cost in either camera. Order C-12R or C-27R. Optional lenses are also available.

PROBES

The standard 10X probes supplied with the instrument satisfy most measurement requirements; however, optional probes (recommended on plug-in unit pages) may be better suited for particular applications.

SCOPE-MOBILE® CART

Model 202-2: storage drawer, carrier for 2 plug-in units, 9-position tilt-lock oscilloscope tray

TV ACCESSORIES FOR GENERAL-PURPOSE OSCILLOSCOPES

In addition to the Tektronix line of television instruments, accessories are available for use with many Tektronix general-purpose oscilloscopes. A TV Sync Separator provides stable triggering for the display of composite video signals. A Video Staircase Differentiator allows the amplitude linearity of television systems and their components to be measured. See the catalog accessory pages for additional information.

*Registered Trade-Mark Polaroid Corporation

Please refer to Terms and Shipment, General Information page.

TYPE **547** **RM547**

DC-to-50 MHz OSCILLOSCOPES

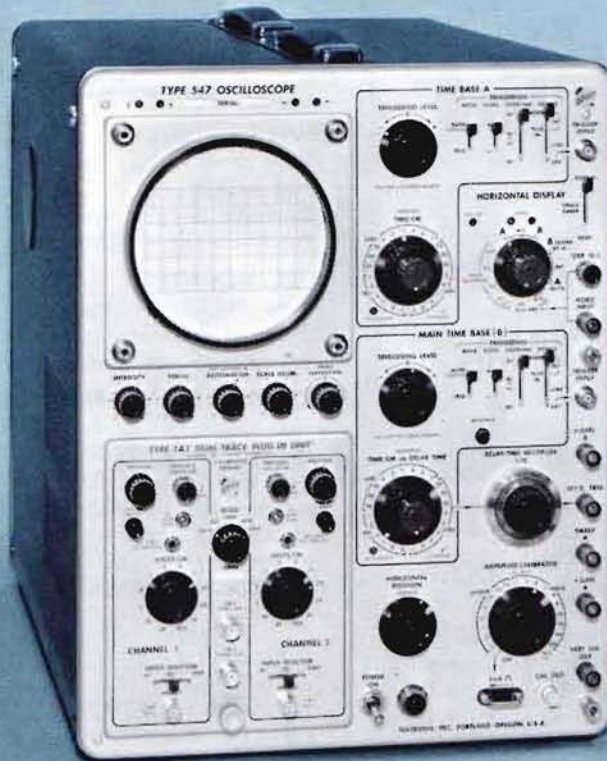

- **AUTOMATIC DISPLAY SWITCHING**
- **CALIBRATED SWEEP DELAY**
- **UNIFORM-FOCUS 6 x 10-CM DISPLAY**
- **ILLUMINATED PARALLAX-FREE GRATICULE**
- **FULL-BANDWIDTH TRIGGERING**
- **ACCEPTS MULTI-TRACE, DIFFERENTIAL, SAMPLING, AND SPECTRUM ANALYZER PLUG-IN UNITS**

Type 547 and RM547 feature AUTOMATIC DISPLAY SWITCHING which provides general dual-beam performance without the additional cost of a dual-beam oscilloscope. With appropriate Plug-In units, both instruments are adaptable to a wide variety of applications such as wide-band response (up to 50 MHz with Type 1A1 Plug-In Unit), differential input, operational, transducer and strain-gage, sampling, and spectrum analysis.

CHARACTERISTIC SUMMARY

VERTICAL

Vertical deflection characteristics are extremely flexible through use of all 1-Series and Letter-Series Plug-In Units.

HORIZONTAL

CALIBRATED TIME BASE—0.1 μ s/cm to 5 s/cm.

SWEEP MAGNIFIER—X2, X5, or X10, extends calibrated time base to 10 ns/cm.

CALIBRATED SWEEP DELAY—0.1 μ s to 50 s.

EXTERNAL INPUT—0.1 V/cm to 1 V/cm deflection factor, DC to 400 kHz.

CRT

DISPLAY AREA—6 x 10 cm.

ACCELERATING VOLTAGE—10 kV.

PHOSPHOR—P31

OTHER

AMPLITUDE CALIBRATOR—0.2 mV to 100 V, 1-kHz square-wave, 100 V DC, 5 mA DC, 5 mA 1-kHz squarewave.

POWER REQUIREMENT—108, 115, 122, 216, 230, or 244 V ($\pm 10\%$ on each range), typically 510 watts.

VERTICAL PLUG-IN UNITS			
PLUG-IN UNIT	MINIMUM DEFLECTION FACTOR	BANDWIDTH (—3 dB)	T _R
MULTIPLE TRACE			
1A1 Dual-Trace	50 mV/cm	DC to 50 MHz	7 ns
	5 mV/cm	DC to 28 MHz	13 ns
	≈500 μV/cm	2 Hz to 15 MHz	24 ns
1A2 Dual-Trace	50 mV/cm	DC to 50 MHz	7 ns
CA Dual-Trace	50 mV/cm	DC to 24 MHz	15 ns
1A4 Four-Trace	10 mV/cm	DC to 50 MHz	7 ns
M Four-Trace	20 mV/cm	DC to 20 MHz	18 ns
SINGLE TRACE			
B	50 mV/cm	DC to 20 MHz	18 ns
	5 mV/cm	2 Hz to 12 MHz	30 ns
H	5 mV/cm	DC to 15 MHz	24 ns
K	50 mV/cm	DC to 30 MHz	12 ns
L	50 mV/cm	DC to 30 MHz	12 ns
	5 mV/cm	3 Hz to 24 MHz	15 ns
SPECIAL PURPOSE			
O Operational	50 mV/cm	DC to 25 MHz	14 ns
Q Strain Gage	10 μstrain/div	DC to 6 kHz	60 μs
DIFFERENTIAL			
1A5 Comparator	5 mV/cm	DC to 50 MHz	7 ns
	2 mV/cm	DC to 45 MHz	8 ns
	1 mV/cm	DC to 40 MHz	9 ns
1A6	1 mV/cm	DC to 2 MHz	0.18 μs
1A7A High-Gain	10 μV/cm	DC to 1 MHz Selectable	350 ns
D	1 mV/cm (to 50 mV/cm)	DC to 300 kHz (DC to 2 MHz)	0.18 μs
E	50 μV/cm (to 10 mV/cm)	0.06 Hz to 20 kHz (to 60 kHz) Selectable	6 μs
G	50 mV/cm	DC to 20 MHz	18 ns
W Comparator	1 mV/cm	DC to 8 MHz	44 ns
	50 mV/cm	DC to 23 MHz	16 ns
Z Comparator	50 mV/cm	DC to 13 MHz	27 ns
SPECTRUM ANALYZERS			
1L5	10 μV/cm	10 Hz to 1 MHz	
1L10	—100 dBm	1 MHz to 36 MHz	
1L20	—110 to —90 dBm	10 MHz to 4.2 GHz	
1L30	—105 to —75 dBm	925 MHz to 10.5 GHz	
WIDE-BAND SAMPLING			
1S1	2 mV/cm	DC to 1 GHz	350 ps
1S2 TDR	5 mρ/cm	140 ps system risetime	
	5 mV/cm	DC to 3.9 GHz	90 ps

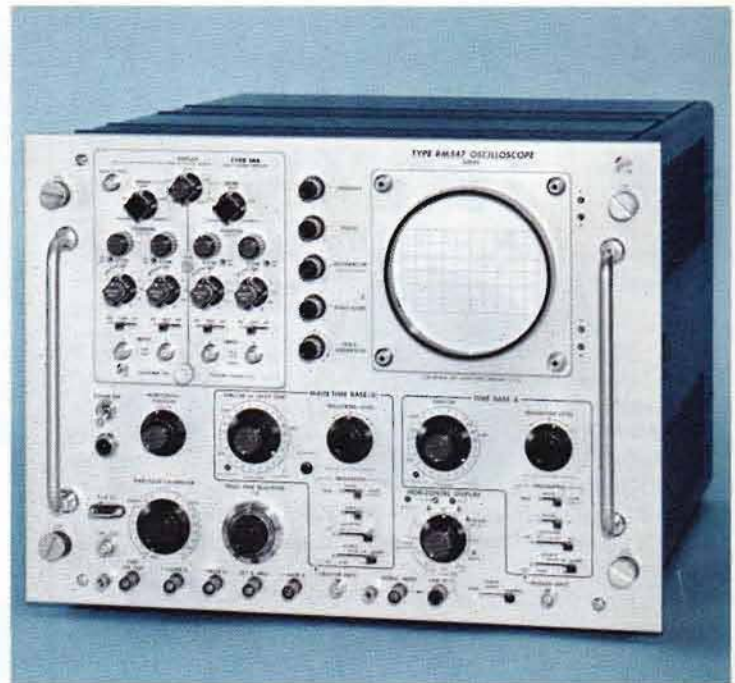

VERTICAL DEFLECTION

BANDWIDTH

DC to 50 MHz at 3-dB down, depending on plug-in unit. See chart.

RISETIME

7 ns, depending on plug-in unit. See chart.

DELAY LINE

Permits viewing leading edge of displayed waveform.

SIGNAL OUTPUT

20-ns risetime, at least 0.3 V for each centimeter of displayed signal.

HORIZONTAL DEFLECTION

TIME BASE A AND B

0.1 μs/cm to 5 s/cm in 24 calibrated steps (1-2-5 sequence), accurate within 2%. Uncalibrated, continuously variable between steps and to approx 12 s/cm. Warning light indicates uncalibrated setting.

MAGNIFIER

X2, X5, or X10 magnification over full time-base, increases fastest rate to 10 ns/cm. Magnified time base accurate within 5%.

DELAY TIME

0.1 μs to 50 s, continuously variable and calibrated, accurate within 1% of indicated delay ±2 minor dial divisions from 50 μs to 50 s. At delay times less than 50 μs add ≤100 ns for fixed delay. Incremental delay-time accurate within 1% ±4 minor dial divisions, from 1 μs to 50 s, ±10 minor divisions at 0.1, 0.2 and 0.5 μs. Uncalibrated delay to approx 120 s. Short-term jitter ≤1/20,000 of total Time Base B delay time.

DELAY MODES

Delayed sweep starts immediately at end of delay time, or is triggerable at end of delay time (for jitter-free displays).

HORIZONTAL DISPLAY

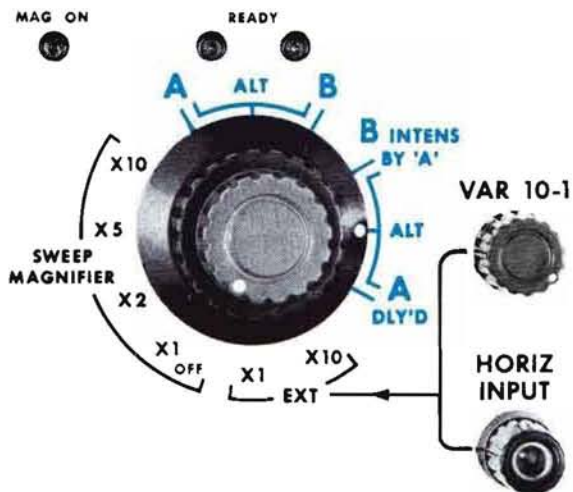

AUTOMATIC DISPLAY SWITCHING

Electronic switching between 2 wide-range time bases allows an alternate presentation of the same signal at 2 different sweep rates. Gallium Arsenide diodes in the switching circuit provide fast switching between time bases, and insure that only the desired time base is displayed at one time.

Two different signals can be alternately displayed at the same or different sweep rates with a Type 1A1 or 1A2 Dual-Trace Unit. With the new Type 1A4 Four-Trace Unit, channels 1 and 2 can be locked to time base A, and channels 3 and 4 can be locked to time base B. In many applications, this provides equivalent dual-beam operation without the additional cost and complexity of a dual-beam oscilloscope. Dual displays are equal in quality to the finest single presentations. Also, the full 6x10-cm screen area can be used to display signals on either time base. A trace separation control operates in conjunction with the normal vertical position to allow full control of dual displays.

DISPLAY MODES

Time Base A only, Time Base B only, A alternated with B, B intensified by A, A delayed by B, B intensified by A alternated with A delayed by B. Single sweep on all the A and the B sweep modes, can be reset at front panel or with $\geq +20$ -V pulse with < 0.5 - μ s risetime, through rear-panel connector.

EXTERNAL INPUT

Fixed steps of approx 0.1 V/cm and 1 V/cm, continuously variable between steps and to approx 10 V/cm, DC to ≥ 400 kHz at -3 dB. 50 V maximum input (DC + peak AC) in most sensitive position. Input RC approx 1 M Ω paralleled by approx 55 pF.

SIGNAL OUTPUTS

Gates from both time bases (positive going from 0 to at least +20 V), sawtooth from Time Base A (positive going from approx 0 to at least +90 V), and a delayed trigger pulse (positive going from 0 to at least +10 V).

TRIGGER

2 identical systems

MODES

Manual level selection with triggered or automatic operation. Automatic operation provides a convenient reference trace with no trigger-signal input, or repetition rates less than 20 Hz. Reference trace is bright throughout the full time-base range.

COUPLING

AC, DC, or AF LF reject.

SOURCES

Internal (from oscilloscope vertical amplifier or direct from a single channel of Type 1A1, 1A2 or 1A4 Plug-In Unit), external, or line. 30 V maximum external input (DC + peak AC). External trigger input RC approx 1.1 M Ω paralleled by approx 30 pF.

REQUIREMENTS

0.2-cm deflection or 0.2 V external at 1 kHz, increasing to 1-cm deflection or 0.2 V external at 50 MHz. Requirements increase below 2 kHz with AC low-frequency reject. DC coupling requires 0.5-cm deflection or 0.2 V external at DC to 50 MHz. ± 2 -V or ± 20 -V trigger level selection.

CRT

TEKTRONIX CRT

5-in metallized screen, helical post accelerating anode, 10-kV accelerating potential for bright displays. Spot diameter with intensity adjusted for typical ambient-light conditions (2- μ A beam current) is nominally 9 mils at center screen, no more than 12 mils at either end of the horizontal axis. P31 phosphor normally supplied. Z-axis input is AC coupled to CRT cathode, requires 15 V peak to peak for beam modulation at normal intensity.

GRATICULE

Internal, parallax-free; variable edge lighting. 6x10-cm display area. Vertical and horizontal center lines marked in 2-mm divisions. Two additional horizontal lines for convenient risetime measurements.

DISPLAY FEATURES

Beam-position indicators show direction of CRT beam when off screen. Multi-trace blanking eliminates switching transients from display when multi-trace plug-in unit is operated in chopped mode.

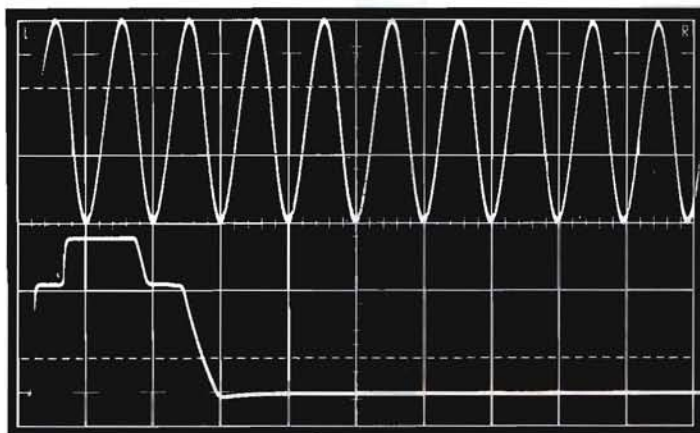

Dual-Scope Operation—Independent control of each signal with Channel 1 of the Type 1A1 Dual-Trace Unit locked to Time Base A, and Channel 2 locked to Time Base B.

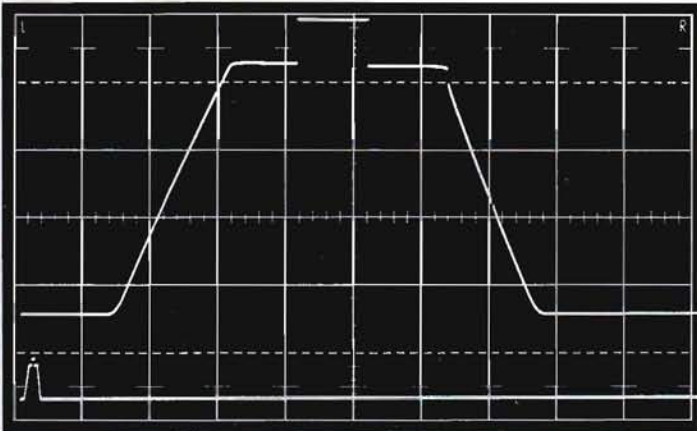

Vertical and Horizontal Expansion—same signal applied to both channels of the Type 1A1 Dual-Trace Unit with independent control of sensitivity and sweep rate in each channel.

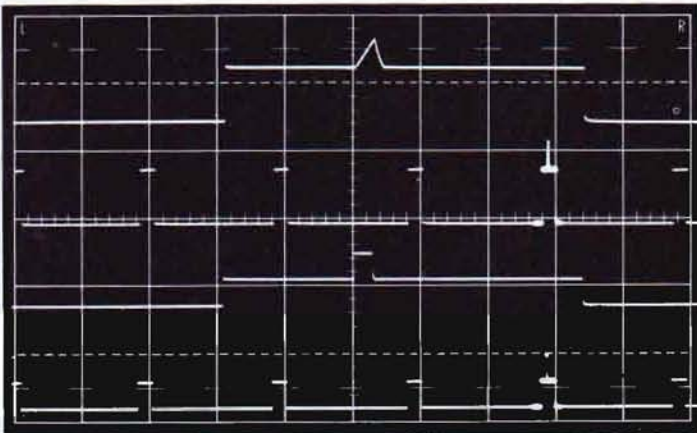

Calibrated Sweep Delay—alternate presentation of 2 signals brightened over a selected portion, and the selected portions expanded to fill 10 cm.

OTHER CHARACTERISTICS

AMPLITUDE CALIBRATOR

0.2 mV to 100 V squarewave, 18 calibrated steps (1-2-5 sequence), accurate within 3%, approx 1-kHz repetition rate. 50-Ω source resistance from 0.2 mV to 0.2 V. 0.6-μs rise-time from 0.2 mV to 5 V; 1-μs from 10 V to 100 V. 100-V DC reference output also provided. Front-panel current loop for 5 mA ±3%, squarewave or DC.

POWER REQUIREMENTS

Wired for 115 V RMS ±10%; transformer taps permit operation at 108, 115, 122, 216, 230, or 244 V (±10% on each range); 50 to 60 Hz. 510 W maximum power consumption. Can be factory wired for any of the above nominal voltages, if so indicated on order.

CABINET MODEL DIMENSIONS AND WEIGHTS

Height	17 in	43.2 cm
Width	12 ⁵ / ₁₆ in	32.9 cm
Depth	23 ⁷ / ₈ in	60.7 cm
Net weight	65 ³ / ₄ lb	29.9 kg
Domestic shipping weight	≈ 85 lb	≈ 38.6 kg
Export-packed weight	≈ 103 lb	≈ 46.8 kg

RACK MODEL DIMENSIONS AND WEIGHTS

Height	14 in	35.6 cm
Width	19 in	48.3 cm
Rack depth	22 ¹ / ₁₆ in	57.6 cm
Net weight	86 ¹ / ₄ lb	39.2 kg
Domestic shipping weight	≈ 114 lb	≈ 51.8 kg
Export-packed weight	≈ 137 lb	≈ 62.3 kg

RACK MOUNTING

Type RM547 withdraws from its cabinet on slide-out tracks, tilts and locks in 7 positions. Further mounting information on catalog instrument dimension page.

INCLUDED STANDARD ACCESSORIES

Two P6008 10X probes (010-0129-00); three BNC-to-BNC 18-in patch cords (012-0087-00); BNC-to-banana plug 18-in patch cord (012-0091-00); BNC post jack (012-0092-00); 3 to 2-wire adapter (103-0013-00); 3-conductor power cord (161-0010-03); smoke-gray light filter, installed (378-0567-00); clear CRT protector plate (387-0918-00); two instruction manuals (070-0398-00). Type RM547 also includes mounting hardware.

OPTIONAL ACCESSORIES

Optional accessories increase measurement capability and provide added convenience. Cameras, probes, Scope-Mobile® Carts and other major accessories are completely described in the catalog accessory pages.

CAMERAS

C-12 has dichroic mirror for straight-on viewing and use of optional projected graticule, f/1.9—1:0.85 lens, Polaroid* Land Pack Film back accepts 3000-speed film

Type 547 to C-12 Camera adapter, order 016-0226-00

C-27 provides direct viewing and maximum transmission of light to film, f/1.9—1:0.85 lens, Polaroid Land Pack Film back accepts 3000-speed film

Type 547 to C-27 Camera adapter, order 016-0225-00

Polaroid Roll Film back accepts 10,000-speed film for increased writing speed, can be substituted at no additional cost in either camera. Order C-12R or C-27R. Optional lenses are also available.

PROBES

The standard 10X probes supplied with the instrument satisfy most measurement requirements; however, optional probes (recommended on plug-in unit pages) may be better suited for particular applications.

SCOPE-MOBILE® CART

Model 202-2: storage drawer, carrier for 2 plug-in units, 9-position tilt-lock oscilloscope tray

TV ACCESSORIES FOR GENERAL-PURPOSE OSCILLOSCOPES

In addition to the Tektronix line of television instruments, accessories are available for use with many Tektronix general-purpose oscilloscopes. A TV Sync Separator provides stable triggering for the display of composite video signals. A Video Staircase Differentiator allows the amplitude linearity of television systems and their components to be measured. See the catalog accessory pages for additional information.

*Registered Trade-Mark Polaroid Corporation

TYPE 549

SPLIT-SCREEN STORAGE OSCILLOSCOPE



- **BISTABLE SPLIT-SCREEN STORAGE AND CONVENTIONAL DISPLAYS**
- **VARIABLE VIEWING TIME**
- **5 cm/ μ s WRITING SPEED**
- **CALIBRATED SWEEP DELAY**
- **FULL-BANDWIDTH TRIGGERING**
- **ACCEPTS MULTI-TRACE, DIFFERENTIAL, SAMPLING, AND SPECTRUM ANALYZER PLUG-IN UNITS**

The Type 549 extends the exclusive Tektronix split-screen and bistable storage features into research and development applications. Offering a high degree of versatility, it accepts all letter-series and 1-series plug-in units covering many applications including sampling and spectrum analysis.

The split-screen, bistable CRT provides high contrast displays and unparalleled writing speeds. Each half of the 6 x 10-cm display area can be independently controlled, thus allowing stored or conventional displays on either the upper or lower half. A stored display can then be compared simultaneously with a conventional display.

A variable-viewing-time system offers a new convenience to storage oscilloscope users. Through front panel controls, this system can be directed to automatically erase either or both halves of the display area after a predetermined viewing time. Viewing time can be varied from ≤ 0.5 seconds to ≥ 5 seconds with AUTO ERASE selected for either PERIODIC or AFTER-SWEEP operation. Used in conjunction with the SINGLE SWEEP, the "After-Sweep" erase circuit automatically resets the Single-Sweep circuit at the end of the viewing-time interval.

CHARACTERISTIC SUMMARY

VERTICAL

Vertical deflection characteristics extremely flexible through use of all Letter-Series and 1-Series Plug-In Units.

HORIZONTAL

CALIBRATED TIME BASE—0.1 μ s/cm to 5 s/cm.

X5 MAGNIFIER—Extends time base to 20 ns/cm.

CALIBRATED SWEEP DELAY—2 μ s to 10 s.

EXTERNAL INPUT—0.2 V/cm, DC to 350 kHz.

STORAGE CRT

DISPLAY AREA—6 x 10 cm.

SPLIT SCREEN STORAGE—Store on either upper or lower half of screen with non-storage on other half; store on entire screen; or non-store on entire screen.

LOCATE ZONE—Locate button permits vertical position finding.

VIEWING TIME—Up to one hour.

ERASE TIME—150 ms maximum.

WRITING SPEED—0.5 cm/ μ s. 5 cm/ μ s with enhancement.

PHOSPHOR—P1

OTHER

AMPLITUDE CALIBRATOR—0.2 mV to 100 V; 5 mA current loop; 1 kHz.

POWER REQUIREMENTS—104, 115, 127, or 208, 230, and 254 volts, center value (regulation range $\pm 10\%$), 650 W (approx) maximum.

AVAILABLE DISPLAYS

With the wide range of vertical plug-in units, several types of stored and conventional displays are obtainable. The Type 549, by virtue of a **new** bistable split-screen storage CRT capable of unparalleled writing speeds, extends storage-measuring capability into previously unattainable areas.

SINGLE-TRACE AND MULTI-TRACE

Multi-trace displays are obtained by selecting a Type 1A1, 1A2, 1A4, CA, or M Amplifier Plug-In Unit. All other 1-Series and Letter-Series Plug-In Units will give single-trace displays. Selection of the Type 1A5, 1A6, 1A7, D, E, or G gives differential amplifier operation, while strain gage and other transducer operations are available with the Type Q Unit.

SAMPLING

Sampling displays with risetimes in the sub-nanosecond region are obtained using a Type 1S1 or 1S2 Sampling Unit. The Type 1S1 is a general-purpose sampler with 1 GHz bandwidth, delay line and internal triggering. The Type 1S2 is designed specifically for TDR (time-domain reflectometry) applications, but offers general-purpose sampling with 3.9 GHz bandwidth and built-in triggering.

SPECTRUM ANALYSIS

Spectral displays are obtained using a Type 1L5, 1L10, 1L20, or 1L30 Spectrum Analyzer Plug-In Unit to cover a frequency range from 10 Hz to 10.5 GHz.

There are decided advantages in using the storage oscilloscope for spectrum analysis. When slow sweep times are used, it is often difficult to view a complete display; however, by storing the display it can be completely and easily observed.

Signal drift is easily measured using the storage technique. The signal is stored and then as subsequent displays are stored, drift of the signal can be observed. Or, the spectral display can be stored on one half of the screen and simply compared with a similar non-stored display on the other.

STORAGE CRT AND DISPLAY FEATURES

STORAGE CRT

Direct viewing, bistable, split-screen, mono-accelerating with 4-kV accelerating potential and separate non-store "locate zone". External edge-lighted graticule. Tektronix bistable storage offers: 1) Brightness of a stored trace independent of viewing time; 2) Contrast of a stored trace independent of viewing time; and 3) Brightness of a stored trace independent of writing speed.

DISPLAY AREA

6 x 10-cm split-screen storage area with independent or common control, plus locate zone.

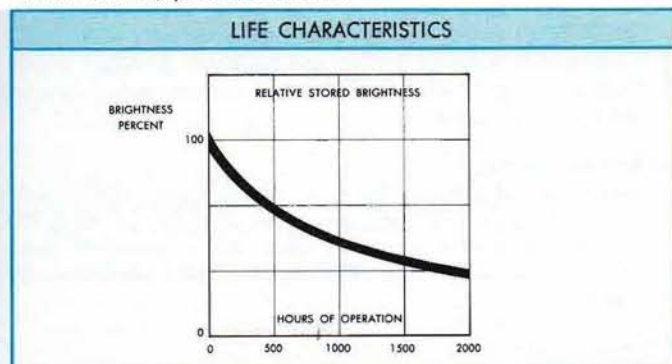

The aging rate of the storage target depends upon the mode of use. The above chart shows typical brightness aging characteristics when the target is used continuously in STORE mode.

SPLIT-SCREEN STORAGE

Store on either upper or lower half of screen with conventional display on other half; store on entire screen; or, non-store on entire screen. Independent operation of both halves.

VIEWING TIME

Up to one hour. If ENHANCE MODE is to be used, it is recommended that displays be stored for 20 minutes or less.

ENHANCE MODE

Controls the single sweep storage capabilities of the storage CRT. Through adjustment of ENHANCE LEVEL control, single-trace spot velocities up to 5 cm/ μ s or better can be stored with minimal loss of resolution and contrast.

LOCATE BUTTON (Serves two functions)

STORAGE—When depressed, the beam appears at the left of the CRT screen marking the vertical position of the next sweep. **CONVENTIONAL DISPLAYS**—Permits beam finding of off screen signals.

ERASE TIME

150 ms maximum.

AUTO ERASE SYSTEM

Viewing time before erase continuously variable from ≤ 0.5 s to ≥ 5 s.

In the PERIODIC Mode, there is a continuous sequence of storing, viewing time and erasure. This sequence occurs regardless of whether or not a signal is present and is independent of the sweep. In the AFTER SWEEP mode—which is used in conjunction with the SINGLE SWEEP—the sequence begins with the arrival of the signal. The signal initiates a sweep by triggering the Single Sweep circuitry. Viewing time begins as the sweep ends. At the end of the viewing time, erasure automatically resets the SINGLE SWEEP, readying it for the next signal. This cycle will automatically repeat itself as long as a signal is available.

Manual control available through Erase and Reset button or by Reset position of Single Sweep switch.

REMOTE CONTROL OPERATION

The Type 549 has remote control-operation capabilities using contact closure. A 9-pin connector, located on the rear panel, supplies one ground and 7 inputs (plus one spare) that allows the following functions:

1. Remote erase of upper screen.
2. Remote erase of lower screen.
3. Remote resetting of sweep for single-sweep operation.
4. Remote erase of both halves of the screen and resetting of the sweep.
5. Remote switching from conventional operation to storage operation (independently or commonly) of upper or lower screen halves.
6. Remote interruption of the Auto Erase sequence in order to hold a stored waveform.

Operation of these circuits is achieved by grounding the appropriate pin in the connector.

REMOTE CONTROL UNIT

(Optional accessory, part number 012-0102-00). Performs Remote Erase and Reset functions numbers 1, 2, and 3 above.

Z-AXIS INPUT

A CRT grid selector switch on the rear panel allows the CRT grid to be driven from the internal unblanking signal, or from an external source. Bandpass is DC to ≥ 1 MHz at -3 dB. 20 V peak to peak required for beam modulation. Input RC is 100 k Ω and 80 pF. A CRT CATHODE-SELECTOR switch allows the cathode to be driven from the internal chopped-blanking signal, or from an external source, AC coupled. 20 V peak to peak required for beam modulation at normal intensity.

TYPE 549

VERTICAL PLUG-IN UNITS			
PLUG-IN UNIT	MINIMUM DEFLECTION FACTOR	BANDWIDTH (-3 dB)	T _R
MULTIPLE TRACE			
1A1 Dual-Trace	50 mV/cm 5 mV/cm ≈500 μV/cm	DC to 30 MHz DC to 23 MHz 2 Hz to 14 MHz	12 ns 16 ns 25 ns
1A2 Dual-Trace	50 mV/cm	DC to 30 MHz	12 ns
CA Dual-Trace	50 mV/cm	DC to 23 MHz	16 ns
1A4 Four-Trace	10 mV/cm	DC to 30 MHz	12 ns
M Four-Trace	20 mV/cm	DC to 19 MHz	19 ns
SINGLE TRACE			
B	50 mV/cm 5 mV/cm	DC to 18 MHz 2 Hz to 12 MHz	20 ns 30 ns
H	5 mV/cm	DC to 14 MHz	25 ns
K	50 mV/cm	DC to 27 MHz	13 ns
L	50 mV/cm 5 mV/cm	DC to 27 MHz 3 Hz to 23 MHz	13 ns 16 ns
SPECIAL PURPOSE			
O Operational	50 mV/cm	DC to 23 MHz	16 ns
Q Strain Gage	10 μstrain/div	DC to 6 kHz	60 μs
DIFFERENTIAL			
1A5 Comparator	5 mV/cm 2 mV/cm 1 mV/cm	DC to 30 MHz DC to 29 MHz DC to 28 MHz	12 ns 13 ns 13 ns
1A6	1 mV/cm	DC to 2 MHz	0.18 μs
1A7A High-Gain	10 μV/cm	DC to 1 MHz Selectable	350 ns
D	1 mV/cm (to 50 mV/cm)	DC to 300 kHz (DC to 2 MHz)	0.18 μs
E	50 μV/cm (to 10 mV/cm)	0.06 Hz to 20 kHz (to 60 kHz) Selectable	6 μs
G	50 mV/cm	DC to 18 MHz	20 ns
W Comparator	1 mV/cm 50 mV/cm	DC to 7 MHz DC to 22 MHz	50 ns 16 ns
Z Comparator	50 mV/cm	DC to 13 MHz	27 ns
SPECTRUM ANALYZERS			
1L5	10 μV/cm	10 Hz to 1 MHz	
1L10	-100 dBm	1 MHz to 36 MHz	
1L20	-110 to -90 dBm	10 MHz to 4.2 GHz	
1L30	-105 to -75 dBm	925 MHz to 10.5 GHz	
WIDE-BAND SAMPLING			
1S1	2 mV/cm	DC to 1 GHz	350 ps
1S2 TDR	5 m _p /cm 5 mV/cm	140 ps system risetime DC to 3.9 GHz	90 ps

VERTICAL DEFLECTION

BANDWIDTH

DC to ≥30 MHz at 3-dB down, depending on plug-in unit. See chart.

RISETIME

≤12 ns, depending on plug-in unit. See chart.

DELAY LINE

Permits viewing leading edge of displayed waveform.

SIGNAL OUTPUT

DC to ≥5 MHz at 3-dB down, ≤70 ns risetime, 1.5 V ±20% for each centimeter of displayed signal.

HORIZONTAL DEFLECTION

TIME BASE A

0.1 μs/cm to 5 s/cm in 24 calibrated steps (1-2-5 sequence), accurate within 3%. Uncalibrated, continuously variable between steps and to approx 12.5 s/cm. Warning light indicates uncalibrated setting.

TIME BASE B

2 μs/cm to 1 s/cm in 18 calibrated steps (1-2-5 sequence), accurate within 3%. Sweep length variable from 4 to 10 cm, allowing use of Time Base B as a repetition-rate generator from 0.1 Hz to 40 kHz.

X5 MAGNIFIER

Operates over full time base, increases fastest Time Base A rate to 20 ns/cm, and the fastest Time Base B rate to 0.4 μs/cm. Magnified time base accurate within 5%.

DELAY TIME

2 μs to 10 s, continuously variable and calibrated, accurate within 1% of indicated delay ±2 minor divisions. Add processing time of 200 ns at fast sweep rates. Incremental delay-time accurate within 1% ±4 minor divisions. Short-term jitter ≤1 part in 20,000 of the available delay time.

DELAY MODES

Depending on the setting of the Delayed Sweep stability control, the Delayed Sweep can start immediately at end of delay time, or be triggerable at end of delay time (for jitter-free displays).

OPERATING MODES

Time Base A, Time Base B, B intensified by A, and A delayed by B. Single sweep in any mode; reset accomplished with ERASE and RESET button on front panel, NORMAL-SINGLE SWEEP-RESET switch on front panel, automatically with AUTO ERASE switch in AFTER SWEEP and NORMAL-SINGLE SWEEP-RESET switch in SINGLE SWEEP, or by remote control through rear-panel connector.

EXTERNAL INPUT

Fixed steps of approx 0.2 V/cm and 2 V/cm, continuously variable between steps and to approx 20 V/cm, DC to ≥350 kHz at -3 dB with maximum gain. 600 V maximum input (DC + peak AC). Input RC approx 1 MΩ paralleled by <60 pF.

SIGNAL OUTPUTS

Gates from both time bases (0 to at least +20 V), sawtooth from Time Base A (0 to at least +130 V), and a delayed trigger pulse (at least +5 V).

STORED DISPLAYS

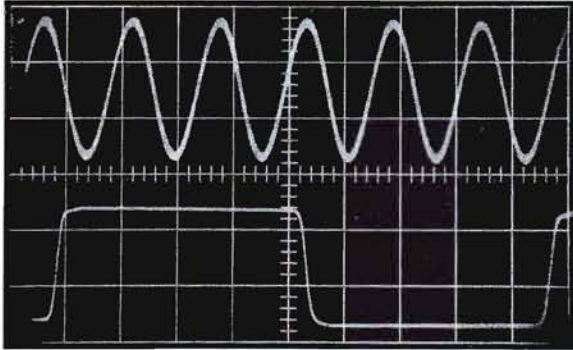

5 cm/ μ s SINGLE-SWEEP WRITING SPEED

Upper display shows a single shot 625-kHz sinewave stored in enhanced mode of operation. Sweep time is 1 μ s/cm.

FAST REPETITIVE DISPLAY

Lower display is a recurrent, 1-MHz squarewave with a risetime of 20 ns stored without enhancement. Sweep time is 0.1 μ s/cm.

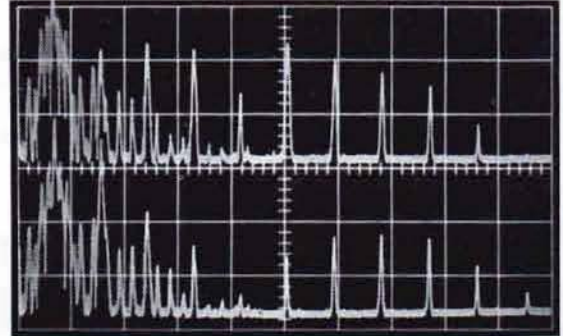

FREQUENCY-BASED DISPLAY

Harmonic analysis of simulated 440-Hz oboe tone (upper) and violin (lower screen). Dispersion is 500 Hz/cm; minimum resolution bandwidth. Zero-frequency feedthrough is displayed in the first centimeter.

TRIGGER

MODES

Automatic or manual level selection. Automatic operation is useful between approx 50 Hz and 1 MHz, minimizes trigger adjustments for signals of different amplitudes, shapes, and repetition rates. With no input (or input less than 50 Hz), automatic triggering occurs at an approx 50-Hz rate, providing a convenient reference trace.

COUPLING

AC, DC, or AC LF reject.

SOURCES

Internal from oscilloscope vertical amplifier (or direct from a single channel of Type 1A1, 1A2 or 1A4 Plug-In Units), external, or line. 50-V maximum external input (DC + peak AC).

TIME BASE A REQUIREMENTS

0.2-cm deflection or 0.3-V external from DC to 10 MHz, increasing to 2-cm deflection or 3-V external at 30 MHz. Requirements increase below 300 Hz with AC coupling, below 200 kHz with AC low-frequency reject. Automatic operation requires 0.2-cm deflection or 0.3-V external from 300 Hz to 10 kHz, increasing to 2-cm deflection or 3-V external at 1 MHz.

TIME BASE B REQUIREMENTS

0.2-cm deflection or 0.3-V external from DC to 1 MHz, increasing to 1-cm deflection or 1.5-V external at 10 MHz. Requirements increase below 300 Hz with AC coupling, below 200 kHz with AC low-frequency reject. Automatic operation requires 0.2-cm deflection or 0.3-V external from 300 Hz to 10 kHz, increasing to 2-cm deflection or 3-V external at 1 MHz.

OTHER CHARACTERISTICS

AMPLITUDE CALIBRATOR

0.2 mV to 100 V squarewave, 18 calibrated steps (1-2-5 sequence), accurate within 2%. 50- Ω \pm 2% source resistance from 0.2 mV to 0.2 V. \approx 1- μ s risetime; 1-kHz \pm 25% repetition rate; 40% to 60% duty cycle. 100-V DC reference output also provided. Front-panel current loop for 5 mA \pm 2%, squarewave or DC.

POWER REQUIREMENTS

Wired for 115 V RMS \pm 10%; rear-panel and internal switches permit operation at 104, 115, 127, 208, 230, or 254 V (\pm 10% on each range); 50 to 60 Hz source having less than 2% harmonic distortion. Approx 650 W maximum power consumption, approx 750 VA maximum.

DIMENSIONS AND WEIGHTS

Height	17 in	43.2 cm
Width	12 ¹⁵ / ₁₆ in	32.9 cm
Depth	23 ⁷ / ₈ in	60.7 cm
Net weight	67 ³ / ₄ lb	30.8 kg
Domestic shipping weight	\approx 89 lb	\approx 40.5 kg
Export-packed weight	\approx 114 lb	\approx 51.8 kg

INCLUDED STANDARD ACCESSORIES

Two P6006 10X probes (010-0127-00); two BNC-to-BNC 18-in patch cords (012-0087-00); BNC-to-binding post adapter (103-0033-00); 3 to 2-wire adapter (103-0013-00); 3-conductor power cord (161-0010-03); smoke-gray light filter (378-0567-00); two instruction manuals (070-0508-00).

TYPE 549

OPTIONAL ACCESSORIES

Optional accessories increase measurement capability and provide added convenience. Cameras, probes, Scope-Mobile® Carts and other major accessories are completely described in the catalog accessory pages.

CAMERA

The standard C-12 camera satisfies most trace-recording requirements. For applications that might require a different viewing system, lens, or back, refer to camera descriptions or consult your field engineer, representative, or distributor.

Standard C-12: f/1.9—1:0.85 lens, no-parallax viewing, Polaroid Land* Pack-Film back

Type 549 to C-12 Camera adapter, order 016-0226-00

PROBES

The standard 10X probes supplied with the instrument satisfy most measurement requirements; however, optional probes (recommended on plug-in unit pages) may be better suited for particular applications.

SCOPE-MOBILE® CART

Model 202-2: storage drawer, carrier for 2 plug-in units, 9-position tilt-lock oscilloscope tray

TV ACCESSORIES FOR GENERAL-PURPOSE OSCILLOSCOPES

In addition to the Tektronix line of television instruments, accessories are available for use with many Tektronix general-purpose oscilloscopes. A TV Sync Separator provides stable triggering for the display of composite video signals. A Video Staircase Differentiator allows the amplitude linearity of television systems and their components to be measured. See the catalog accessory pages for additional information.

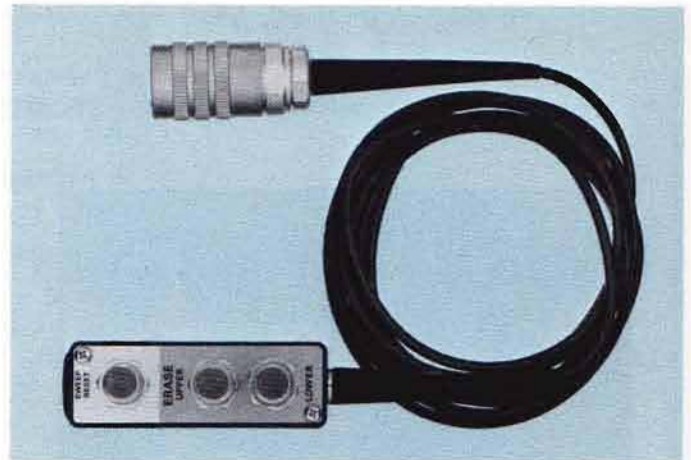

REMOTE-CONTROL UNIT

Separate controls for erase of upper screen, erase of lower screen, and single-sweep reset. Mates to oscilloscope rear-panel connector, 9-foot cable, order 012-0102-00

REMOTE-CONTROL CONNECTOR

9-pin cable connector for 5 erase and reset functions plus selection of storage or non-storage operation. Mates to oscilloscope rear-panel connector. Cable and control unit not included, order 134-0049-00

RACK-MOUNT ADAPTER

Consists of cradle to support the Type 549 in any standard 19-in relay rack, and mask to fit around the front panel. Requires 17½-in panel height, order 040-0281-00

*Registered Trade-Mark Polaroid Corporation

Please refer to Terms and Shipment, General Information page.

DC-to-27 MHz DUAL-BEAM OSCILLOSCOPE



- **TWO VERTICAL-DEFLECTION SYSTEMS**
- **COMMON HORIZONTAL DEFLECTION**
- **4 x 10-CM DISPLAY PER BEAM**
- **ACCEPTS MULTI-TRACE, DIFFERENTIAL, SAMPLING, AND SPECTRUM ANALYZER PLUG-IN UNITS**

The Type 551 uses a Tektronix two-gun cathode-ray tube with two pairs of vertical-deflection plates. A single pair of horizontal-deflection plates is common to both electron beams. The two wide-band main amplifiers in the Type 551 are designed for Tektronix Letter-Series and 1-Series Plug-In Units, providing a high degree of signal-handling versatility in both channels. Both electron beams are simultaneously deflected horizontally at any one of many sweep rates provided by an accurately-calibrated time base generator.

CHARACTERISTIC SUMMARY

VERTICAL

2 identical vertical-deflection systems.

Letter-Series and 1-Series Plug-in Units offer a wide selection of vertical-deflection characteristics for both beams.

HORIZONTAL

CALIBRATED TIME BASE—0.1 μ s/cm to 5 s/cm.

5X MAGNIFIER—Extends time base to 20 ns/cm.

EXTERNAL INPUT—0.2 V to 50 V/cm; DC to 400 kHz.

CRT

DISPLAY AREA—4 x 10 cm (each beam), 2-cm overlap.

ACCELERATING VOLTAGE—10 kV.

PHOSPHOR—P2

OTHER

AMPLITUDE CALIBRATOR—0.2 mV to 100 V, 1-kHz square-wave.

POWER REQUIREMENTS—105 V to 125 V or 210 V to 250 V, 900 watts maximum.

TYPE 551

VERTICAL PLUG-IN UNITS			
PLUG-IN UNIT	MINIMUM DEFLECTION FACTOR	BANDWIDTH (-3 dB)	T _R
MULTIPLE TRACE			
1A1 Dual-Trace	50 mV/cm 5 mV/cm ≈500 μV/cm	DC to 27 MHz DC to 21 MHz 2 Hz to 13 MHz	13 ns 17 ns 27 ns
1A2 Dual-Trace	50 mV/cm	DC to 27 MHz	13 ns
CA Dual-Trace	50 mV/cm	DC to 22 MHz	16 ns
1A4 Four-Trace	10 mV/cm	DC to 27 MHz	13 ns
M Four-Trace	20 mV/cm	DC to 19 MHz	19 ns
SINGLE TRACE			
B	50 mV/cm 5 mV/cm	DC to 18 MHz 2 Hz to 12 MHz	20 ns 30 ns
H	5 mV/cm	DC to 14 MHz	25 ns
K	50 mV/cm	DC to 25 MHz	14 ns
L	50 mV/cm 5 mV/cm	DC to 25 MHz 3 Hz to 22 MHz	14 ns 16 ns
SPECIAL PURPOSE			
O Operational	50 mV/cm	DC to 23 MHz	16 ns
Q Strain Gage	10 μstrain/div	DC to 6 kHz	60 μs
DIFFERENTIAL			
1A5 Comparator	5 mV/cm 2 mV/cm 1 mV/cm	DC to 27 MHz DC to 26 MHz DC to 25 MHz	13 ns 14 ns 14 ns
1A6	1 mV/cm	DC to 2 MHz	0.18 μs
1A7A High-Gain	10 μV/cm	DC to 1 MHz Selectable	350 ns
D	1 mV/cm (to 50 mV/cm)	DC to 300 kHz (DC to 2 MHz)	0.18 μs
E	50 μV/cm (to 10 mV/cm)	0.06 Hz to 20 kHz (to 60 kHz) Selectable	6 μs
G	50 mV/cm	DC to 18 MHz	20 ns
W Comparator	1 mV/cm 50 mV/cm	DC to 7.5 MHz DC to 20 MHz	47 ns 18 ns
Z Comparator	50 mV/cm	DC to 13 MHz	27 ns
SPECTRUM ANALYZERS			
1L5	10 μV/cm	10 Hz to 1 MHz	
1L10	-100 dBm	1 MHz to 36 MHz	
1L20	-110 to -90 dBm	10 MHz to 4.2 GHz	
1L30	-105 to -75 dBm	925 MHz to 10.5 GHz	
WIDE-BAND SAMPLING			
1S1	2 mV/cm	DC to 1 GHz	350 ps
1S2 TDR	5 mV/cm 5 mV/cm	140 ps system risetime DC to 3.9 GHz	90 ps

VERTICAL DEFLECTION

2 identical systems

BANDWIDTH

DC to 27 MHz at 3-dB down, depending on plug-in unit. See chart.

RISETIME

13 ns, depending on plug-in unit. See chart.

DELAY LINE

Permits viewing leading edge of displayed waveform.

HORIZONTAL DEFLECTION

Common to both beams

TIME BASE

0.1 μs/cm to 5 s/cm in 24 calibrated steps (1-2-5 sequence), accurate within 3%. Uncalibrated, continuously variable between steps and to approx 12 s/cm. Warning light indicates uncalibrated setting.

X5 MAGNIFIER

Operates over full time base, increases fastest rate to 20 ns/cm. Magnified time base accurate within 5%.

OPERATING MODES

Normal, single sweep.

EXTERNAL INPUT

Continuously variable from 0.2 V/cm to 50 V/cm, DC to ≥400 kHz at -3 dB. 50-V maximum input (DC + peak AC) in most sensitive position. Input RC approx 100 kΩ paralleled by approx 30 pF.

SIGNAL OUTPUTS

Gate (positive going from 0 to at least +20 V), sawtooth (positive going from 0 to at least +150 V). Cathode follower outputs.

TRIGGER

MODES

Automatic or manual level selection; high-frequency sync. Automatic operation is useful between approx 50 Hz and 2 MHz, minimizes trigger adjustments for signals of different amplitudes, shapes, and repetition rates. With no input (or input less than 40 Hz), automatic triggering occurs at an approx 50-Hz rate, providing a convenient reference trace. High-frequency sync assures a steady display of sinewaves from approx 5 MHz to 30 MHz.

COUPLING

AC, DC, or AC LF reject.

SOURCES

Internal (from either oscilloscope vertical amplifier), external, or line. External trigger input RC approx 1 MΩ paralleled by approx 55 pF.

REQUIREMENTS

0.2-cm deflection or 0.2-V external from DC to below 5 MHz, increasing to 1-cm deflection or 1-V external at 5 MHz. Requirements increase below 16 Hz with AC coupling, below 16 kHz with AC low-frequency reject. Automatic operation requires 0.4-cm deflection or 0.4-V external from 60 Hz to 250 kHz, increasing to 1-cm deflection or 1-V external at 2 MHz. High-frequency sync requires 2-cm deflection or 2-V external from approx 5 Hz to 30 MHz.

CRT

TEKTRONIX DUAL-BEAM CRT

4 x 10-cm display per beam with at least 2-cm overlap. Separate vertical-deflection plates; common horizontal deflection plates. Metallized screen, helical post accelerating anode. 10-kV accelerating potential for bright displays. P2 phosphor normally supplied. Z-axis input is AC coupled to CRT cathode, requires 20 V peak to peak for beam modulation at normal intensity.

GRATICULE

External; variable edge lighting. 6 x 10-cm display area. Vertical and horizontal center lines marked in 2-mm divisions.

DISPLAY FEATURES

Beam-position indicators show direction of each CRT beam when off screen.

OTHER CHARACTERISTICS

AMPLITUDE CALIBRATOR

0.2 mV to 100 V squarewave, 18 calibrated steps (1-2-5 sequence), accurate within 3%, approx 1-kHz repetition rate.

POWER REQUIREMENTS

Wired for 105 to 125 VAC (117 V nominal); transformer taps permit operation at 107, 117, 127, 214, 234 or 254 VAC: 50 to 60 Hz. 850 W maximum power consumption. Can be factory wired for any of the above nominal voltages, if so indicated on order.

OSCILLOSCOPE DIMENSIONS AND WEIGHTS

Height	17 in	43.2 cm
Width	12 ⁵ / ₁₆ in	32.9 cm
Depth	23 ⁷ / ₈ in	60.7 cm
Net weight	51 ³ / ₄ lb	23.5 kg
Domestic shipping weight	71 lb	32.3 kg
Export-packed weight	92 lb	41.8 kg

POWER SUPPLY DIMENSIONS AND WEIGHTS

Height	10 ⁹ / ₁₆ in	26.8 cm
Width	13 ⁵ / ₁₆ in	33.8 cm
Depth	17 ⁷ / ₁₆ in	44.3 cm
Net weight	43 ¹ / ₂ lb	19.8 kg
Domestic shipping weight	52 lb	23.6 kg
Export-packed weight	71 lb	32.3 kg

INCLUDED STANDARD ACCESSORIES

Four P6006 10X probes (010-0127-00); two BNC-to-BNC 18-in patch cords (012-0087-00); BNC-to-banana plug 18-in patch cord (012-0091-00); BNC post jack (012-0092-00); 3 to 2-wire adapter (103-0013-00); 3-conductor power cord (161-0010-03); inter-unit cable (012-0032-01); smoke-gray light filter (378-0567-00); two instruction manuals (070-0245-00).

OPTIONAL ACCESSORIES

Optional accessories increase measurement capability and provide added convenience. Cameras, probes, Scope-Mobile® Carts and other major accessories are completely described in the catalog accessory pages.

CAMERA

The standard C-12 camera satisfies most trace-recording requirements. For applications that might require a different viewing system, lens, or back, refer to camera descriptions or consult your field engineer, representative, or distributor.

Standard C-12: f/1.9—1:0.85 lens, no parallax viewing, Polaroid Land* Pack-Film back

Type 551 to C-12 Camera adapter, order 016-0226-00

PROBES

The standard 10X probes (P6006) supplied with the instrument satisfy most voltage measurement requirements; however, optional probes (recommended on plug-in unit pages) may be better suited for particular applications.

SCOPE-MOBILE® CART

Model 202-2: storage drawer, carrier for 2 plug-in units, 9-position tilt-lock oscilloscope tray

INTER-UNIT CABLE

Six-foot cable allows increased separation of Type 551 and Power Supply, order 012-0051-00

RACK-MOUNT ADAPTER

Consists of two cradles to support the Type 551 and Power Supply in any standard 19-in relay rack, and two masks to fit around the front panels. Requires 17¹/₂-in panel height for Type 551, 12¹/₄-in panel height for Power Supply. Order 040-0279-00

*Registered Trade-Mark Polaroid Corporation

Please refer to Terms and Shipment, General Information page.

TYPE 556 R556

DC-to-50 MHz DUAL-BEAM OSCILLOSCOPES

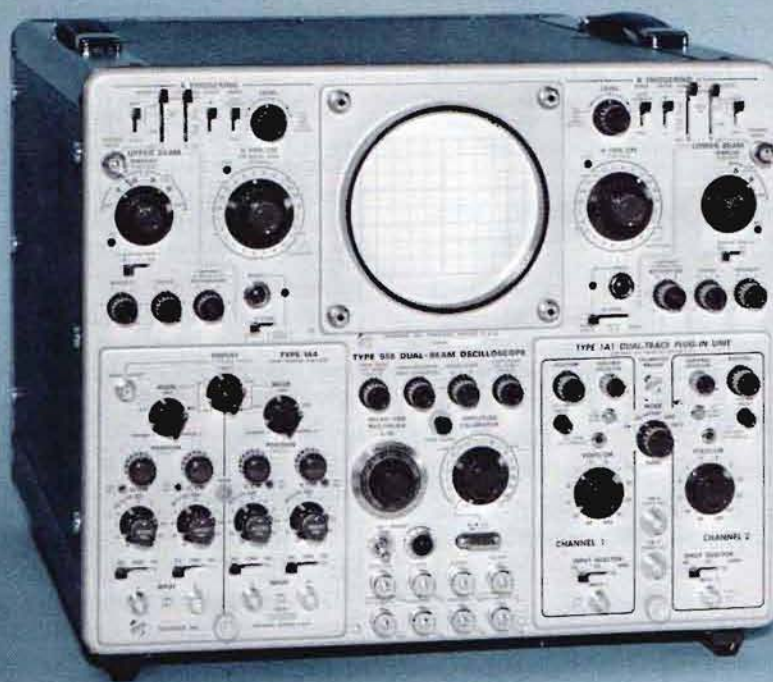

- TWO VERTICAL AND HORIZONTAL SYSTEMS
- OVER 50 DISPLAY MODES INCLUDING DUAL-BEAM DISPLAY WITH ONE INPUT
- CALIBRATED SWEEP DELAY
- EMI SUPPRESSION
- 6 x 10-CM DISPLAY PER BEAM
- ILLUMINATED PARALLAX-FREE GRATICULE
- FULL-BANDWIDTH TRIGGERING
- ACCEPTS MULTI-TRACE, DIFFERENTIAL, SAMPLING, AND SPECTRUM ANALYZER PLUG-IN UNITS

The Type 556 and R556 are dual-beam laboratory instruments for accurate measurement in the DC to 50 MHz range. Features include independent vertical and horizontal deflection systems, trigger selectability for cross triggering, and uniform-focus CRT with 6 x 10-cm scan per beam.

Unique display capability allows simultaneous display of one signal at two different sweep times, using only one probe for minimum circuit loading.

CHARACTERISTIC SUMMARY

VERTICAL

2 identical vertical-deflection systems

Letter-Series and 1-Series Plug-In Units offer wide selection of vertical-deflection characteristics for both beams.

HORIZONTAL

2 independent horizontal-deflection systems

CALIBRATED TIME BASE—0.1 μ s/cm to 5 s/cm.

X10 MAGNIFIER—Extends time base to 10 ns/cm.

CALIBRATED SWEEP DELAY—0.1 μ s to 50 s.

EXTERNAL INPUT— \leq 0.1 V/cm to approx 10 V/cm; DC to \geq 400 kHz.

CRT

DISPLAY AREA—6 x 10 cm per beam, 4-cm overlap.

ACCELERATING VOLTAGE—10 kV.

PHOSPHOR—P31

OTHER

ELECTROMAGNETIC INTERFERENCE—Meets MIL-I-6181D, Radiated: 150 kHz to 1 GHz; Conducted: 150 kHz to 25 MHz.

AMPLITUDE CALIBRATOR—1-kHz squarewave; 0.2 mV to 100 V; 100 VDC; 5 mA, 1-kHz squarewave; 5 mA DC.

POWER REQUIREMENTS—90 VAC to 136 VAC, 180 VAC to 272 VAC; 50 to 60 Hz; \approx 840 watts, 1 kVA (maximums).

VERTICAL PLUG-IN UNITS			
PLUG-IN UNIT	MINIMUM DEFLECTION FACTOR	BANDWIDTH (—3 dB)	T _R
MULTIPLE TRACE			
1A1 Dual-Trace	50 mV/cm 5 mV/cm ≈500 μV/cm	DC to 50 MHz DC to 28 MHz 2 Hz to 15 MHz	7 ns 13 ns 24 ns
1A2 Dual-Trace	50 mV/cm	DC to 50 MHz	7 ns
CA Dual-Trace	50 mV/cm	DC to 24 MHz	15 ns
1A4 Four-Trace	10 mV/cm	DC to 50 MHz	7 ns
M Four-Trace	20 mV/cm	DC to 20 MHz	18 ns
SINGLE TRACE			
B	50 mV/cm 5 mV/cm	DC to 20 MHz 2 Hz to 12 MHz	18 ns 30 ns
H	5 mV/cm	DC to 15 MHz	24 ns
K	50 mV/cm	DC to 30 MHz	12 ns
L	50 mV/cm 5 mV/cm	DC to 30 MHz 3 Hz to 24 MHz	12 ns 15 ns
SPECIAL PURPOSE			
O Operational	50 mV/cm	DC to 25 MHz	14 ns
Q Strain Gage	10 μstrain/div	DC to 6 kHz	60 μs
DIFFERENTIAL			
1A5 Comparator	5 mV/cm 2 mV/cm 1 mV/cm	DC to 50 MHz DC to 45 MHz DC to 40 MHz	7 ns 8 ns 9 ns
1A6	1 mV/cm	DC to 2 MHz	0.18 μs
1A7A High-Gain	10 μV/cm	DC to 1 MHz Selectable	350 ns
D	1 mV/cm (to 50 mV/cm)	DC to 300 kHz (DC to 2 MHz)	0.18 μs
E	50 μV/cm (to 10 mV/cm)	0.06 Hz to 20 kHz (to 60 kHz) Selectable	6 μs
G	50 mV/cm	DC to 20 MHz	18 ns
W Comparator	1 mV/cm 50 mV/cm	DC to 8 MHz DC to 23 MHz	44 ns 16 ns
Z Comparator	50 mV/cm	DC to 13 MHz	27 ns
SPECTRUM ANALYZERS			
1L5	10 μV/cm	10 Hz to 1 MHz	
1L10	—100 dBm	1 MHz to 36 MHz	
1L20	—110 to —90 dBm	10 MHz to 4.2 GHz	
1L30	—105 to —75 dBm	925 MHz to 10.5 GHz	
WIDE-BAND SAMPLING			
1S1	2 mV/cm	DC to 1 GHz	350 ps
1S2 TDR	5 mp/cm	140 ps system risetime	
	5 mV/cm	DC to 3.9 GHz	90 ps

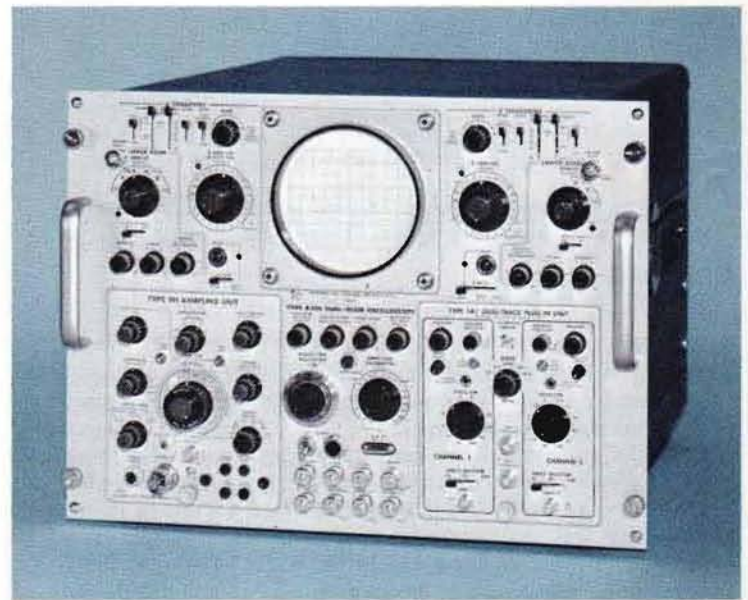

VERTICAL DEFLECTION

2 identical systems

BANDWIDTH

DC to ≥50 MHz at 3-dB down, depending on plug-in unit. See chart.

RISETIME

≤7 ns, depending on plug-in unit. See chart.

DELAY LINE

Permits viewing leading edge of displayed waveform.

HORIZONTAL DEFLECTION

2 identical systems

TIME BASE A AND B

0.1 μs/cm to 5 s/cm in 24 calibrated steps (1-2-5 sequence), accurate within 3%. Uncalibrated, continuously variable between steps and to approx 12.5 s/cm. Warning light indicates uncalibrated setting.

X10 MAGNIFIER

Operates over full time base, increases fastest rate to 10 ns/cm. Magnified time base accurate within 5%.

DELAY TIME

0.1 μs to 50 s, continuously variable and calibrated, accurate within 1% of indicated delay ±2% of A TIME/CM setting (±5% from 0.5 μs/cm to 0.1 μs/cm) + fixed delay in system of ≤150 ns. Incremental delay-time accurate within 1% of indicated incremental delay ±4% of A TIME/CM setting (±7% from 0.5 μs/cm to 0.1 μs/cm). Uncalibrated delay to approx 120 s. Short-term jitter ≤1 part in 20,000 of the available delay time.

DELAY MODES

Delayed sweep starts immediately at end of delay time, or is triggerable at end of delay time (for jitter-free displays).

OPERATING MODES

Time Base A—Normal and Single Sweep.

Time Base B—Normal, B delayed by A, and Single Sweep.

EXTERNAL INPUT

≤0.1 V/cm with X10 Display Mag, ≤1 V/cm with X1 Display Mag, continuously variable from ≤0.1 V/cm to approx 10 V/cm. DC to ≥400 kHz at 3-dB down. 50-V maximum (DC + peak AC). Input RC approx 1 megohm paralleled by approx 65 pF.

TYPE **556** **R556**

SIGNAL OUTPUTS

Gates from both time bases ($\geq +10$ V), sawtooths from both time bases (≥ 9 V/cm), delayed trigger pulse (≥ 7 V).

TRIGGER

2 identical systems

MODES

Triggered and Auto Stability. Latter mode free runs sweep in absence of triggering signal, triggers on signals ≥ 30 Hz.

COUPLING

AC, DC, AC LF reject, AC HF reject.

SOURCES

Internal from left or right vertical amplifier, left or right plug-in, external, or line. External trigger input RC approx 1 megohm paralleled by approx 35 pF. 50-V maximum external input (DC + peak AC). External trigger signals that have an amplitude greater than 2 V and a rate of rise exceeding 1/3 V/ns may cause erratic triggering. Internal source selectable from the oscilloscope vertical amplifier, or direct from a single channel of Type 1A1, 1A2, and 1A4 Plug-In Units. The latter mode displays the true time relationship between signals when plug-in units are in chopped or alternate operation.

REQUIREMENTS

AC INTERNAL—0.2-cm deflection, 60 Hz to 10 MHz increasing to 1 cm at 50 MHz.

AC EXTERNAL—0.2 V, 60 Hz to 10 MHz increasing to 0.4 V at 50 MHz.

AC LF REJECT—INT: or EXT: Requirement increases below 2.5 kHz (≥ 3 -cm deflection or ≥ 3 V at 30 Hz).

AC HF REJECT—INT: or EXT: Requirement increases above 60 kHz (≥ 1 -cm deflection or ≥ 1 V at 6 MHz).

DC INTERNAL—0.35-cm deflection, DC-to-10 MHz; increasing to 2 cm at 50 MHz.

DC EXTERNAL—0.2 V, DC-to-10 MHz; increasing to 0.4 V at 50 MHz.

DISPLAY LOGIC

A dual-beam oscilloscope, with two horizontal and vertical deflection systems, presents the ability to select the driving deflection source to the deflection systems . . . thereby greatly increasing the versatility.

The Time Base generators can be switched to either UPPER-BEAM horizontal or LOWER-BEAM horizontal to give independent time-based displays, identical time-based displays, or simultaneous display of one time base delayed accurately by the other.

The signal under test has the potential to be channeled from the plug-ins to either vertical amplifier. In the Type 556, the RIGHT plug-in unit output can be directed to either the UPPER-BEAM vertical or the LOWER-BEAM vertical or both. This means, among other things, only one probe need be attached to the signal source to perform delaying sweep operations. This reduces the loading effect on sensitive circuitry. The LEFT plug-in unit can be coupled to the UPPER-BEAM vertical only, since the redundant switching capability would not add greatly to measurement ability.

The triggering signal source to each Time Base trigger circuit can be selected from either UPPER-BEAM or LOWER-BEAM vertical (NORM), RIGHT or LEFT plug-in unit (necessary only in 1-series multi-trace plug-ins), or EXTERNAL. This virtually eliminates the need to procure any additional trigger signal for such applications as time relation measurements or dual-trace operation.

Following are presentations of the front-panel controls which program display logic, and descriptions (with waveforms) of a few of many display combinations.

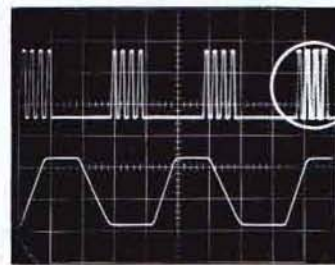
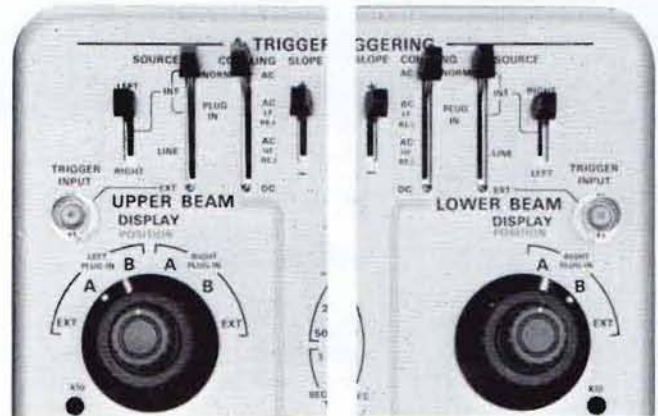

SINGLE-INPUT DUAL-BEAM DISPLAYS (Above left)

Upper beam shows bursts of 2.5 MHz pulses on Time Base A with time variation between bursts. This shows up as increasing time-jitter between the first and successive bursts. The lower beam shows Time Base B (0.1 μ s/cm) delayed by Time Base A and triggered on the second pulse of the last burst to provide a jitter-free expanded display of the A Sweep intensified zone. The use of only one probe and one plug-in input simplifies signal connection and provides minimum loading on the signal source.

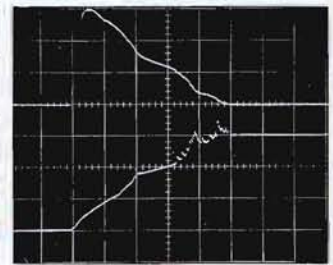

SIMULTANEOUS SINGLE-SHOT DISPLAYS (Above right)

Current versus voltage display of a 0.75 ampere, fast-blow fuse during destructive overload. Both beams are driven by B Time Base (50 μ s/cm) which is delayed by pre-triggered A Time Base to provide base reference lines before and after the event. The upper beam shows the current through the fuse at 30 A/cm while the lower beam shows the corresponding voltage across the fuse at 100 V/cm.

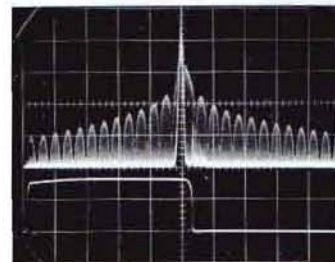

TIME AND FREQUENCY DISPLAYS (Above left)

Upper beam shows the spectral output of a 200-MHz gated oscillator applied as IF feedthrough to a Type 1L20 Spectrum Analyzer; the calibrated dispersion is 1 MHz/cm. The lower beam shows a real-time display of the 10-kHz gating pulse (0.5 μ s/cm).

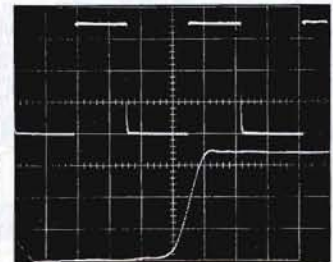

SAMPLING AND REAL-TIME DISPLAYS (Above right)

Upper beam shows a squarewave at 1 μ s/cm, as applied to a Type 1A2 Plug-In. The lower beam shows the leading-edge of the same waveform at 1 ns/cm, as applied to a Type 1S1 Wide-Band Sampling Plug-In.

CRT AND DISPLAY FEATURES

TEKTRONIX DUAL-BEAM CRT

5-inch round tube, 8 x 10 cm display area; $\geq 6 \times 10$ cm per beam with 4-cm overlap. Spot size, focus uniformity and geometry equivalent to our finest single-beam tubes. Aluminized construction, helical post acceleration. P31 phosphor. Z-axis input requires 10 V peak to peak for CRT modulation at normal intensity.

INTERNAL GRATICULE

Variable edge lighting. Vertical and horizontal centerlines marked in 2-mm divisions.

DISPLAY CONTROLS

Separate intensity, focus and astigmatism controls for each beam, upper and lower beam intensity contrast controls between A sweep and non-intensified-B-zone of A sweep, trace rotation (screwdriver adjustment), and trace separation. BEAM FINDER button functions in both X-Y systems, indicates direction of off-screen signals.

OTHER CHARACTERISTICS

ELECTROMAGNETIC INTERFERENCE

Oscilloscopes meet interference specifications of MIL-I-6181 D over the following frequency ranges: Radiated (with CRT mesh filter and BNC connector covers installed) —150 kHz to 1 GHz; conducted (power line) —150 kHz to 25 MHz.

AMPLITUDE CALIBRATOR

0.2 mV to 100 V in 18 calibrated steps (1-2-5 sequence), accuracy within $\pm 2\%$. 50- Ω source resistance from 0.2 mV to 0.2 V. ≤ 1.5 - μ s risetime; 1-kHz $\pm 25\%$ repetition rate; 45% to 55% duty cycle. 100-V DC reference output also provided. Front-panel current loop for 5 mA $\pm 2\%$, squarewave or DC.

POWER REQUIREMENTS

90 to 136 VAC or 180 to 272 VAC, 50 to 60 Hz source with less than 2% harmonic distortion; approx 840 W maximum, approx 1 kVA maximum. Rear-panel selector provides rapid accommodation for six line-voltage ranges.

CABINET MODEL DIMENSIONS AND WEIGHTS

Height	15 ³ / ₁₆ in	38.6 cm
Width	16 ⁵ / ₁₆ in	43.0 cm
Depth	24 in	61.0 cm
Net Weight	83 lb	37.7 kg
Domestic shipping weight	≈ 135 lb	≈ 61.5 kg
Export-packed weight	≈ 148 lb	≈ 67.3 kg

RACK MODEL DIMENSIONS AND WEIGHTS

Height	14 in	35.6 cm
Width	19 in	48.3 cm
Rack depth	22 ¹³ / ₁₆ in	57.9 cm
Net weight	87 ³ / ₄ lb	39.9 kg
Domestic shipping weight	≈ 151 lb	≈ 68.6 kg
Export-packed weight	≈ 162 lb	≈ 73.6 kg

RACK MOUNTING

Type R556 mounts on tilting slide-out tracks to standard 19-inch rack. Further mounting information on catalog instrument dimension page.

INCLUDED STANDARD ACCESSORIES

Four P6008 10X probes (010-0129-00); eighteen BNC caps, ten installed (016-0088-00); 3 to 2-wire adapter (103-0013-00); 3-conductor power cord (161-0030-01); smoke gray light filter (378-0567-00); clear CRT protector plate (387-0918-00); grati-cule cover (200-0382-00); CRT mesh filter, installed (378-0572-00); two instruction manuals (070-0757-00). Type R556 also includes mounting tracks (351-0086-00) and mounting hardware; two instruction manuals (070-0758-00).

OPTIONAL ACCESSORIES

Optional accessories increase measurement capability and provide added convenience. Cameras, probes, Scope-Mobile® Carts and other major accessories are completely described in the catalog accessory pages.

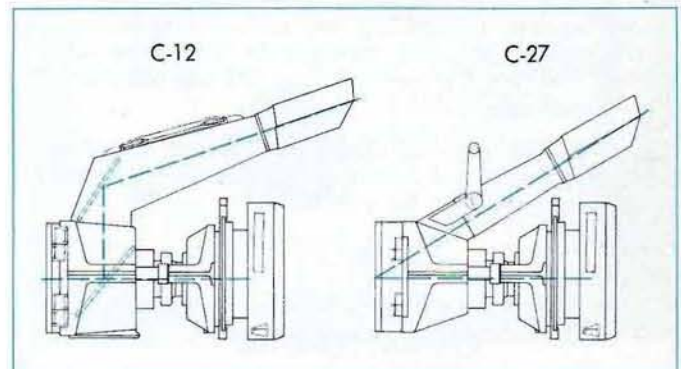

CAMERAS

C-12 has beam-splitting mirror for straight-on-viewing and use of optional projected graticule, f/1.9—1:0.85 lens, Polaroid* Land Pack Film back accepts 3000-speed film

Type 556 to C-12 Camera adapter, order 016-0226-00

C-27 provides direct viewing and maximum transmission of light to film, f/1.9—1:0.85 lens, Polaroid Land Pack Film back accepts 3000-speed film

Type 556 to C-27 Camera adapter, order 016-0225-00

Polaroid Roll Film back accepts 10,000-speed film for increased writing speed, can be substituted at no additional cost in either camera. Order C-12R or C-27R. Optional lenses are also available.

PROBES

The standard 10X probes supplied with the instrument satisfy most measurement requirements; however, optional probes (recommended on plug-in unit pages) may be better suited for particular applications.

SCOPE-MOBILE® CART

Model 205-2: storage drawer, carrier for 3 plug-in units, 9-position tilt-lock oscilloscope tray

*Registered Trade-Mark, Polaroid Corporation

Please refer to Terms and Shipment, General Information page.

TYPE B

DC-to-20 MHz UNIT

- 5 mV/cm to 20 V/cm
CALIBRATED DEFLECTION FACTOR
- LOW COST

The Type B Plug-In Preamp meets the requirements of many wide-band applications. Wide bandwidth, excellent transient response, DC-coupling, and calibrated deflection factors are qualities most users require in an oscilloscope vertical amplifier. The Type B is used with Type 530, 540, 550 and 580* Series Oscilloscopes.

Type 127, 132, and 133 Power Supplies are available to operate this plug-in unit outside an oscilloscope. See description of these instruments for details.

CHARACTERISTICS

TYPE B AND OSCILLOSCOPE	DEFLECTION FACTOR	BANDWIDTH† (-3 dB)	RISETIME
531A, 533A, 535A	50 mV/cm to 20 V/cm	DC to 14 MHz	25 ns
	5 mV/cm to 20 mV/cm	2 Hz to 10 MHz	35 ns
536	50 mV/cm to 20 V/cm	DC to 10 MHz	35 ns
	5 mV/cm to 20 mV/cm	2 Hz to 9 MHz	40 ns
543B, 544, 545B, 546, 547, 555, 556, 581A*, 585A*	50 mV/cm to 20 V/cm	DC to 20 MHz	18 ns
	5 mV/cm to 20 mV/cm	2 Hz to 12 MHz	30 ns
549, 551	50 mV/cm to 20 V/cm	DC to 18 MHz	20 ns
	5 mV/cm to 20 mV/cm	2 Hz to 12 MHz	30 ns

*A Type 81A Adapter is required.

†Low-frequency 3-dB point, AC coupled: 2 Hz, 0.2 Hz with 10X probe.

DEFLECTION FACTOR

5 mV/cm to 20 V/cm in 12 calibrated steps (1-2-5 sequence), accurate within 3%. AC coupled at 5 mV/cm to 20 mV/cm. Uncalibrated, continuously variable between steps and to approx 50 V/cm.

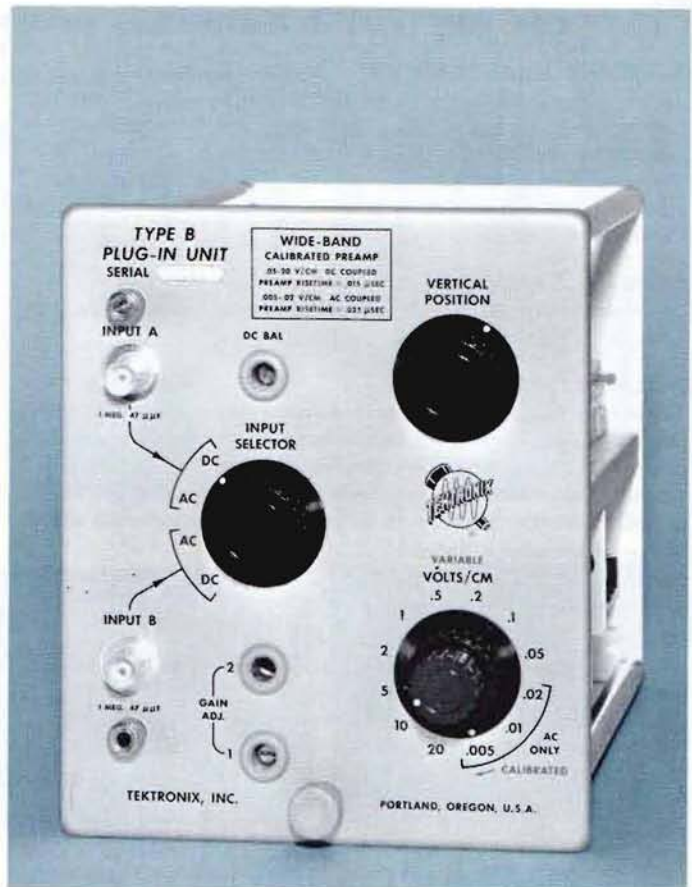

INPUT

1 megohm paralleled by approx 47 pF.
600 V DC + peak AC max input voltage.

INPUT SELECTION

Two inputs, front-panel selection of either.

WEIGHTS

Net weight	4 lb	1.8 kg
Domestic shipping weight	≈ 7 lb	≈ 3.2 kg
Export-packed weight	≈ 11 lb	≈ 5.0 kg

INCLUDED STANDARD ACCESSORIES

Two instruction manuals (070-0219-00).

OPTIONAL ACCESSORIES

The probes recommended for use with this plug-in unit satisfy most measurement requirements. Other probes are available for current and high-voltage measurements. See catalog accessory pages for additional information on these and other items.

P6006* 10X Probe Package, order 010-0127-00

P6007 100X Probe Package, order 010-0150-00

P6028 1X Probe Package, order 010-0074-00

*Included with Type 531A, 533A, 536, 535A, 543B, 545B, 549, 551 and 555 Oscilloscopes.

Please refer to Terms and Shipment, General Information page.

DC-to-20 MHz DIFFERENTIAL UNIT

- **50 mV/CM to 20 V/CM
CALIBRATED DEFLECTION FACTOR**
- **100:1 COMMON-MODE REJECTION**

The Type G Plug-In Unit equips Tektronix Type 530, 540, 550 and 580* Series Oscilloscopes for wideband differential-input applications. Common-mode rejection is better than 100 to 1 for the entire bandwidth at full gain. Independent step attenuators in each input with 80-dB isolation permit mixing signals of wide amplitude difference. Either input can be used separately, INPUT B giving a polarity-inverted display.

Type 127, 132, and 133 Power Supplies are available to operate this plug-in outside an oscilloscope. See the description of these instruments for details.

Differential input permits measurements in which the output is proportional to the difference between signals applied to inputs A and B. Differential operation is useful for measurements between 2 points, differing in potential, and for cancellation of in-phase signals such as hum pickup at the signal source.

CHARACTERISTICS

TYPE G UNIT AND OSCILLOSCOPE	BANDWIDTH† (-3 dB)	RISETIME
531A, 533A, 535A	DC to 14 MHz	25 ns
536	DC to 10 MHz	35 ns
543B, 544, 545B, 546, 547, 555, 556, 581A*, 585A*	DC to 20 MHz	18 ns
549, 551	DC to 18 MHz	20 ns

*A Type 81A Adapter is required.

†Low-frequency 3-dB point, AC coupled: 2 Hz, 0.2 Hz with 10X probe.

DEFLECTION FACTOR

50 mV/cm to 20 V/cm in 9 calibrated steps (1-2-5 sequence), accurate within 3%. Uncalibrated, continuously variable between steps and to approx 50 V/cm.

INPUT

1 megohm paralleled by approx 47 pF.
600 V DC + peak AC max input voltage.

OPERATING MODES

Input A only, input B only (inverted), A-B (differential).



COMMON-MODE REJECTION

Better than 100:1 at 20 MHz and 50 mV/cm, better than 300:1 at 60 Hz. Common-mode signal should not exceed 2 V peak-to-peak between input grids. At 0.5 V/cm and 5 V/cm, signals should not exceed 20 V and 200 V respectively.

WEIGHTS

Net weight	4½ lb	1.9 kg
Domestic shipping weight	≈ 7 lb	≈ 3.2 kg
Export-packed weight	≈ 12 lb	≈ 5.5 kg

INCLUDED STANDARD ACCESSORIES

Two instruction manuals (070-0241-00).

OPTIONAL ACCESSORIES

The probes recommended for use with this plug-in unit satisfy most measurement requirements. Other probes are available for current and high-voltage measurements. See catalog accessory pages for additional information on these and other items.

P6007 100X Probe Package, order 010-0134-00

P6023 10X Probe Package, adjustable attenuation ratio helps maintain common-mode rejection, order 010-0167-00

P6028 1X Probe Package, order 010-0074-00

Please refer to Terms and Shipment, General Information page.

TYPE H

DC-to-15 MHz UNIT

- 5 mV/CM to 20 V/CM
CALIBRATED DEFLECTION FACTOR

The Type H is a DC to 15 MHz Preamplifier for use with Types 530, 540, 550, and 580* Series Oscilloscopes. It provides DC coupling from two front panel inputs with deflection factors of 5 mV/cm to 20 V/cm.

Type 127, 132, and 133 Power Supplies are available to operate this plug-in outside an oscilloscope. See the description of these instruments for details.

CHARACTERISTICS

TYPE H UNIT AND OSCILLOSCOPE	BANDWIDTH† (-3 dB)	RISETIME
531A, 533A, 535A	DC to 11 MHz	32 ns
536	DC to 9.5 MHz	37 ns
543B, 544, 545B, 546, 547, 555, 556, 581A*, 585A*	DC to 15 MHz	24 ns
549, 551	DC to 14 MHz	25 ns

*A Type 81A Adapter is required.

†Low-frequency 3-dB point, AC coupled: 2 Hz, 0.2 Hz with 10X probe.

DEFLECTION FACTOR

5 mV/cm to 20 V/cm in 12 calibrated steps (1-2-5 sequence), accurate within 3%. Uncalibrated, continuously variable between steps and to approx 50 V/cm.

INPUT

1 megohm paralleled by approx 47 pF.
600 V DC + peak AC max input voltage.

INPUT SELECTION

Two inputs, front-panel selection of either.



WEIGHTS

Net weight	3 ³ / ₄ lb	1.7 kg
Domestic shipping weight	≈ 7 lb	≈ 3.2 kg
Export-packed weight	≈ 11 lb	≈ 5.0 kg

INCLUDED STANDARD ACCESSORIES

Two instruction manuals (070-0272-00).

OPTIONAL ACCESSORIES

The probes recommended for use with this plug-in unit satisfy most measurement requirements. Other probes are available for current and high-voltage measurements. See catalog accessory pages for additional information on these and other items.

P6006* 10X Probe Package, order 010-0127-00

P6007 100X Probe Package, order 010-0150-00

P6028 1X Probe Package, order 010-0074-00

*Included with Type 531A, 533A, 535A, 536, 543B, 545B, 549, 551 and 555 Oscilloscopes.

Please refer to Terms and Shipment, General Information page.

DC-to-30 MHz UNIT

- 50 mV/CM to 20 V/CM
CALIBRATED DEFLECTION FACTOR
- LOW COST

The Type K Fast-Rise Unit provides Type 540, 550, and 580* Series Oscilloscopes with calibrated deflection factors at low input capacitance, taking maximum advantage of the excellent transient response and wide frequency range of the oscilloscope vertical-deflection system. The Type K combined with a fast-rise oscilloscope makes a 12-nanosecond risetime combination, ideal for applications involving fast-rising waveforms.

Type 127, 132, and 133 Power Supplies are available to operate this plug-in outside an oscilloscope. See the description of these instruments for details.



CHARACTERISTICS

TYPE K UNIT AND OSCILLOSCOPE	BANDWIDTH† (-3 dB)	RISETIME
531A, 533A, 535A	DC to 15 MHz	24 ns
536	DC to 11 MHz	32 ns
543B, 544, 545B, 546, 547, 555, 556, 581A*, 585A*	DC to 30 MHz	12 ns
549	DC to 27 MHz	13 ns
551	DC to 25 MHz	14 ns

*A Type 81A Adapter is required.

†Low-frequency 3-dB point, AC coupled: 2 Hz, 0.2 Hz with 10X probe.

DEFLECTION FACTOR

50 mV/cm to 20 V/cm in 9 calibrated steps (1-2-5 sequence), accurate within 3%. Uncalibrated, continuously variable between steps and to approx 50 V/cm.

INPUT

1 megohm paralleled by approx 20 pF.
600 V DC + peak AC max input voltage.

WEIGHTS

Net weight	3½ lb	1.6 kg
Domestic shipping weight	≈ 6 lb	≈ 2.7 kg
Export-packed weight	≈ 11 lb	≈ 5.0 kg

INCLUDED STANDARD ACCESSORIES

Two instruction manuals (070-0230-00).

OPTIONAL ACCESSORIES

The probes recommended for use with this plug-in unit satisfy most measurement requirements. Other probes are available for current and high-voltage measurements. See catalog accessory pages for additional information on these and other items.

P6006* 10X Probe Package, order 010-0127-00

P6007 100X Probe Package, order 010-0150-00

P6028 1X Probe Package, order 010-0074-00

*Included with Type 531A, 533A, 535A, 536, 543B, 545B, 549, 551 and 555 Oscilloscopes.

Please refer to Terms and Shipment, General Information page.

TYPE L

DC-to-30 MHz UNIT

- 5 mV/CM to 20 V/CM
CALIBRATED DEFLECTION FACTOR

The Type L Fast-Rise High-Gain Unit duplicates the performance of the Type K and offers an extended deflection factor to 5 mV/cm, AC-coupled. An AC-coupled amplifier provides a gain of 10X with slightly reduced bandwidth.

Type 127, 132, and 133 power supplies are available to operate this plug-in outside an oscilloscope. See the description of these instruments for details.

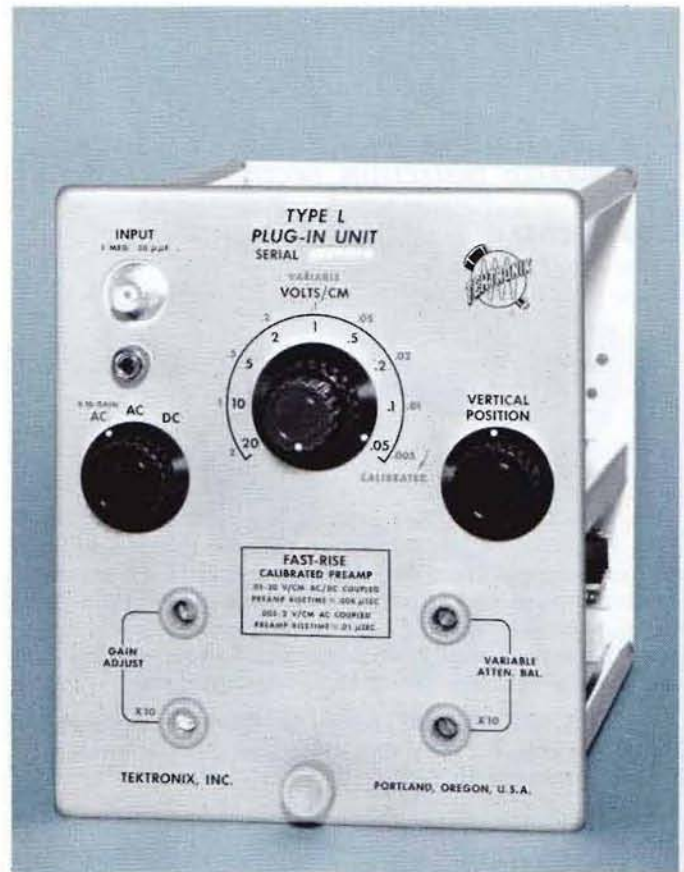

CHARACTERISTICS

TYPE L AND OSCILLOSCOPE	DEFLECTION FACTOR	BANDWIDTH† (-3 dB)	RISE-TIME
531A, 533A, 535A	50 mV/cm to 20 V/cm 5 mV/cm to 2 V/cm	DC to 15 MHz 3 Hz to 14 MHz	24 ns 25 ns
536	50 mV/cm to 20 V/cm 5 mV/cm to 2 V/cm	DC to 11 MHz 3 Hz to 10 MHz	32 ns 35 ns
543B, 544, 545B, 546, 547, 555, 556, 581A*, 585A*	50 mV/cm to 20 V/cm 5 mV/cm to 2 V/cm	DC to 30 MHz 3 Hz to 24 MHz	12 ns 15 ns
549	50 mV/cm to 20 V/cm 5 mV/cm to 2 V/cm	DC to 27 MHz 3 Hz to 23 MHz	13 ns 16 ns
551	50 mV/cm to 20 V/cm 5 mV/cm to 2 V/cm	DC to 25 MHz 3 Hz to 22 MHz	14 ns 16 ns

*A Type 81A Adapter is required.

†Low-frequency 3-dB point, AC coupled: 2 Hz, 0.2 Hz with 10X probe.

DEFLECTION FACTOR

50 mV/cm to 20 V/cm in 9 calibrated steps (1-2-5 sequence), accurate within 3%. 5 mV/cm to 2 V/cm in 9 calibrated steps, AC coupled, using X10 gain. Uncalibrated, continuously variable between steps and to approx 50 V/cm.

INPUT

1 megohm paralleled by approx 20 pF.
600 V DC + peak AC max input voltage.

WEIGHTS

Net weight	4¼ lb	1.9 kg
Domestic shipping weight	≈ 7 lb	≈ 3.2 kg
Export-packed weight	≈ 12 lb	≈ 5.5 kg

INCLUDED STANDARD ACCESSORIES

Two instruction manuals (070-0336-00).

OPTIONAL ACCESSORIES

The probes recommended for use with this plug-in unit satisfy most measurement requirements. Other probes are available for current and high-voltage measurements. See catalog accessory pages for additional information on these and other items.

P6006* 10X Probe Package, order 010-0127-00

P6007 100X Probe Package, order 010-0150-00

P6028 1X Probe Package, order 010-0074-00

*Included with Type 531A, 533A, 535A, 536, 543B, 545B, 549, 551 and 555 Oscilloscopes.

Please refer to Terms and Shipment, General Information page.

OPERATIONAL AMPLIFIER UNIT



- TWO OPERATIONAL AMPLIFIERS
- 15 MHz OR GREATER GAIN-BANDWIDTH PRODUCT
- 2500 OR GREATER OPEN-LOOP GAIN
- SELECTABLE INTERNAL Z_i AND Z_f COMPONENTS
- PROVISION FOR EXTERNAL Z_i AND Z_f COMPONENTS

The Type O Operational Amplifier Unit performs integration, differentiation, function generation, linear and non-linear amplification. It contains two operational amplifiers and a display amplifier. Each operational amplifier has identical features, including front-panel selection of internal Z_i and Z_f components. External components can be used independently or in combination with the internal resistor-capacitor combinations. The output of either operational amplifier can be applied to the other operational amplifier; either output can be applied to the display amplifier. The results can be viewed on Tektronix Type 530, 540, 550, and 580* Series Oscilloscopes and/or fed to other devices.

Type 127, 132, and 133 Power Supplies are available to operate this plug-in unit outside an oscilloscope. See description of these instruments for details.

DISPLAY AMPLIFIER

TYPE O UNIT AND OSCILLOSCOPE	BANDWIDTH† (-3 dB)	RISETIME
531A, 533A, 535A	DC to 14 MHz	25 ns
536	DC to 10 MHz	35 ns
543B, 544, 545B, 546, 547, 555, 556, 581A*, 585A*	DC to 25 MHz	14 ns
549, 551	DC to 23 MHz	16 ns

*A Type 81A Adapter is required.

†Low-frequency 3-dB point, AC coupled: 2 Hz, 0.2 Hz with 10X probe.

DEFLECTION FACTOR

50 mV/cm to 20 V/cm in 9 calibrated steps (1-2-5 sequence), accurate within 3%. Uncalibrated, continuously variable between steps and to approx 50 V/cm.

INPUT

1 megohm paralleled by approx 47 pF.
600 V DC + peak AC max input voltage.

OPERATING MODES

Signal source selection from either operational amplifier or an external signal. AC or DC coupling. The display can be inverted to provide the desired deflection polarity.

OPERATIONAL AMPLIFIERS

OPEN-LOOP GAIN

2500 minimum.

OPEN-LOOP GAIN-BANDWIDTH PRODUCT

15 MHz or greater; checked at 10 MHz for open-loop gain greater than 1.5.

CLOSED-LOOP BANDWIDTH

750 kHz or greater at unity gain with internal input and feedback resistors, up to 10 MHz with external compensation (such as provided by the optional Compensating Adapter).

OUTPUT RANGE

± 50 V, ± 5 mA.

OUTPUT DC LEVEL

Adjustable to ground at front panel.

OUTPUT IMPEDANCE

Approx 30 Ω at 1 MHz for compensated unity-gain amplifier.

DRIFT

Typically <10 mV/hour referred to input (after warmup).

NOISE

Typically <0.5 mV peak-to-peak (equivalent input noise), approx 3 mV peak-to-peak additional output noise when $R_f = 1$ megohm.

GRID CURRENT

<0.5 nA for each input grid; adjustable to <0.3 nA for -grid and <0.15 nA for +grid.

CROSSTALK BETWEEN AMPLIFIERS

$\geq 300:1$ with 1-kHz squarewave.

FEEDBACK

Provision for negative and/or positive feedback. Negative feedback utilizes internal and/or external impedances; positive feedback utilizes external impedances only.

SELECTABLE INPUT AND FEEDBACK COMPONENTS

Front-panel switches allow independent selection of the following resistors and capacitors in any combination as Z_i and Z_f : 10, 100, 200 and 500 k Ω , 1 M Ω ; 10 and 100 pF, 0.001, 0.01, 0.1, and 1 μ F. All values are $\pm 1\%$ except 10 and 100 pF which are adjustable.

INTEGRATION LOW-FREQUENCY REJECT

For high-frequency integration applications, reduces integration of drift and signals below approx 1 Hz or 1 kHz; can be switched out when desired.

TYPE O

TERMINAL ADAPTERS

Two shielded adapters included for construction of external circuitry for custom applications. Suggested circuits for special applications are shown in the instruction manual.

WEIGHTS

Net weight	5½ lb	2.5 kg
Domestic shipping weight	≈10 lb	≈4.5 kg
Export-packed weight	≈14 lb	≈6.4 kg

INCLUDED STANDARD ACCESSORIES

Two terminal adapters (103-0048-01); two terminal shields (013-0049-01); two BNC-to-binding post adapters (103-0033-00); two BNC-to-BNC 18-in patch cords (012-0087-00); two instruction manuals (070-0323-00).

BASIC OPERATING MODES

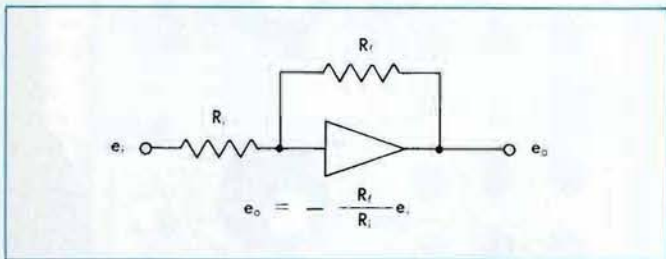

AMPLIFICATION is determined by the ratio of input to feedback resistors. This provides convenient signal step-up or step-down, with low output impedances, to over 750 kHz. Use of external compensation extends the closed-loop gain-bandwidth product to 10 MHz or more.

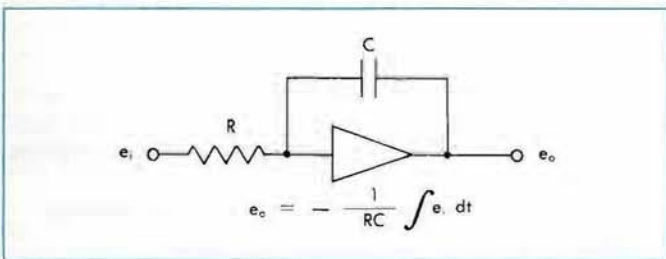

INTEGRATION is obtained by placing a capacitor in the feedback loop. Unlike the RC integrator, this circuitry permits loading of the output, and integration without loss of signal level. Integration at repetition rates of approximately 5 MHz is possible. Low-frequency rejection allows drift-free repetitive-waveform integration.

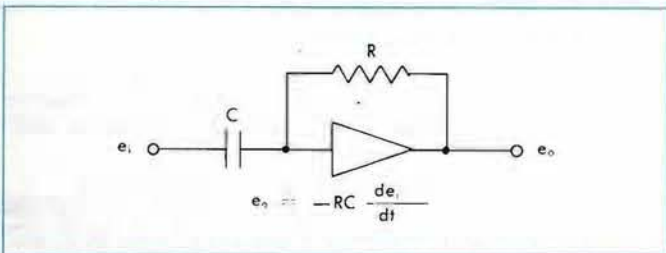

DIFFERENTIATION is accomplished by placing a capacitor in the input circuit. The unique characteristic of differentiation is its ability to extract higher frequency waveform components. It can advantageously detect minute information such as transients and slope changes. Differentiation of waveforms with significant components as high as 1.5 MHz is possible.

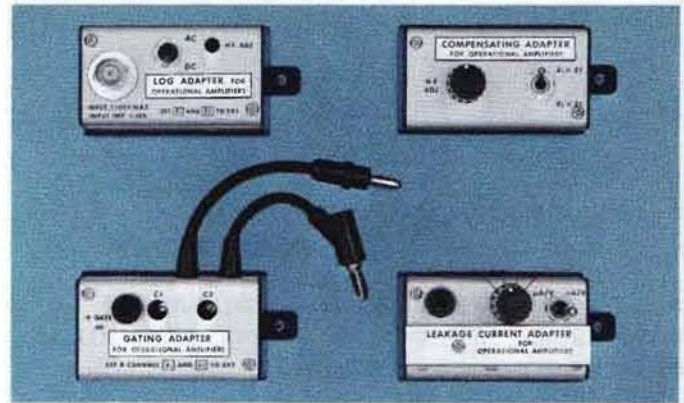

OPTIONAL ACCESSORIES LOG ADAPTER

The Log Adapter with the Type O Plug-In Unit allows the display and measurement of high-amplitude signals mixed with low-amplitude signals. Pulses and transient waveforms differing in amplitude by up to 1000 to 1 can be displayed and measured on the same trace.

The Log Adapter is a logarithmic feedback network that converts the A or B operation amplifier in a Type O Plug-In Unit from a linear amplifier to essentially a logarithmic amplifier. The adapter can be plugged directly into the jacks on the front panel of the Type O Plug-In Unit.
Order 013-0067-00

COMPENSATING ADAPTER

The Compensating Adapter extends the high-frequency performance of either operational amplifier of the Type O Plug-In Unit when the internal Z_i and Z_f resistors are used in any combination for either gain or attenuation.

Without the Compensating Adapter, stray capacitance associated with the internal Z_i and Z_f resistors limits the operational amplifiers high-frequency performance. The adapter can be plugged into the front panel of the Type O Plug-In Unit.
Order 013-0081-00

GATING ADAPTER

The Gating Adapter allows integration and display of repetitive signals, by resetting the integrator to zero during the oscilloscope's retrace time. The adapter uses Operational Amplifier "B" of the Type O to gate Amplifier "A" on and off in response to an external gating signal, such as the +Gate from the oscilloscope. The signal applied to Amplifier "A" is then amplified, integrated, or differentiated only during the "on" time.
Order 013-0068-00

LEAKAGE CURRENT ADAPTER

Used with the Type O Plug-In Unit, the Leakage Current Adapter provides the facility for measuring leakage current of semiconductor diodes and small signal transistors.

The adapter plugs into the operational jacks located on the front panel of the Type O Unit. A positive-going sawtooth voltage is required for driving the adapter. Tektronix Oscilloscopes that accept the Type O Plug-In Unit have a Sawtooth or Sweep-Out jack conveniently located on the front panel for supplying the required sawtooth voltage.
Order 013-0086-00

Please refer to the catalog accessory pages for complete information on the above adapters.

Please refer to Terms and Shipment, General Information page.

TRANSDUCER & STRAIN GAGE UNIT

- HIGH GAIN
- LOW NOISE
- ESSENTIALLY DRIFT FREE

The Type Q Plug-In Unit permits any Tektronix Type 530, 540, 550, or 580* Series Oscilloscope to be operated with strain gages and other transducers. Designed to measure any mechanical quantity that can be converted to a change in resistance, capacitance, or inductance—through use of a suitable transducing device—this versatile unit provides high gain, low noise, and extremely-low drift. Suppressed-carrier amplitude modulation is produced by unbalancing an AC bridge with the strain gages or other transducers. Phase-sensitive demodulation produces the proper deflected-trace direction.

Requiring no external equipment other than the strain gages or transducers operated with it and the associated oscilloscope, the Tektronix Type Q Plug-In Unit bridges the gap between mechanical engineering and electronic instrumentation. Total range of applications is as broad as the mechanical field itself. Applications include stress analysis, vibration studies, and fatigue tests. Typical quantities that can be measured with the unit are force, displacement, acceleration, and strain.

Type 127, 132, and 133 Power Supplies are available to operate this plug-in outside an oscilloscope. See the description of these instruments for details.

BANDWIDTH

DC to 6 kHz at 3-dB down.

RISETIME

Approximately 60 μ s.

CALIBRATED DEFLECTION FACTOR

10 μ strain (microinches per inch) /div to 10,000 μ strain/div in 10 calibrated steps (1-2-5 sequence), when used with a single strain gage having a gage factor of approx 2. With four active arms and a gage factor of 2, deflection factor extends to 2.5 μ strain/div. Attenuator accurate within 2%. Uncalibrated, continuously variable between steps and to approx 25,000 μ strain/div. Warning light indicates uncalibrated setting.

AMPLIFIER INPUT

Input is to an AC bridge with 25-kHz excitation voltage. One or more of the four bridge arms can have transducers attached to them. Total bridge voltage is approximately 5 V RMS, regulated.

*A Type 81A Adapter is required.



NOISE

Typically equivalent to an input of 1.5 microstrain (peak to peak) at maximum calibrated sensitivity. This approximates an RMS noise of 0.5 microstrain.

DRIFT

Drift of the over-all system is primarily a function of the transducer stability. The Type Q Amplifier system is essentially drift free.

GAGE FACTORS

Factors from 1 to 6 are usable without changing the steps of the μ strain/div control. The range of factors is compensated for by adjusting the Gain Adjust Control.

EQUIVALENT DC SENSITIVITY

A comparable DC amplification system would require a deflection factor of approx 10 μ V/div for the same amount of power applied to the input bridge.

CAPACITIVE TRANSDUCERS

Use in conjunction with a four-arm resistive bridge results in the following maximum useful deflection capabilities: 120-ohm bridge (available internally), 1 pF/div; 1000-ohm bridge, 0.2 pF/div; useful deflection capabilities are slightly lower when using long cables.

INDUCTIVE TRANSDUCERS

Must have characteristics compatible with the 25-kHz carrier frequency to function properly. Linear-variable-differential transformers designed for nominal carrier frequencies of 2 kHz and higher usually operate satisfactorily without additional circuitry.

TYPE Q

Dynamic plot of the depletion-layer capacitance of a back-biased diode.

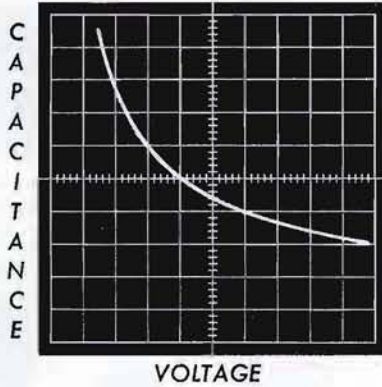

Pressing force can be accurately controlled by using the Type Q Unit.

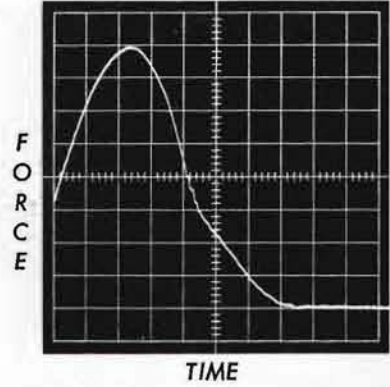

TRANSDUCER CABLE

Either 3-wire or 4-wire shielded microphone cable gives the best results in most applications.

CAPACITANCE BRIDGE BALANCE

A vernier control allows compensation for an unbalance of up to 250 pF across any external resistive arm of the input bridge.

RESISTANCE BRIDGE BALANCE

A vernier control provides sufficient range to compensate for most standard transducers and strain gages.

GAGE RESISTANCE RANGE

Useful with cable lengths to 100 feet; extends from approximately 50 ohms to 2000 ohms. For optimum performance, the recommended range is between 120 and 500 Ω .

PHASE ADJUSTMENT

Permits either resistive or reactive transducer applications to be displayed.

CALIBRATION SWITCH

A rotary switch connects a calibration resistor across the

strain gage to electrically simulate an external mechanical strain. The calibration resistor supplied with the Type Q Unit simulates a -400 microstrain unbalance of the bridge and is suitable for most strain gage applications. The calibration resistor is mounted on a handy plug-in receptacle. No special gage dial is necessary for the unit.

To aid in calibration, a nomograph is included in the instruction manual. This nomograph relates calibration of the supplied resistor to gage factors and strain gage resistances. To include the gage factor in the calibration, merely increase or decrease the amplifier gain proportionally.

WEIGHTS

Net weight	5 $\frac{1}{4}$ lb	2.4 kg
Domestic Shipping weight	\approx 9 lb	\approx 4.1 kg
Export-packed weight	\approx 14 lb	\approx 6.4 kg

INCLUDED STANDARD ACCESSORIES

4-wire 15-ft shielded connector cable (012-0040-00); two instruction manuals (070-0199-00).

Please refer to Terms and Shipment, General Information page.

DIFFERENTIAL COMPARATOR UNIT

- 1 mV/CM TO 50 V/CM CALIBRATED DEFLECTION FACTOR
- UP TO 23-MHz BANDWIDTH
- 20,000:1 COMMON-MODE REJECTION
- 11,000 cm EFFECTIVE SCREEN HEIGHT

The Type W High-Gain Differential Comparator adds to the measurement capabilities of Tektronix Type 530, 540, 550 and 580* Series Oscilloscopes. Used with Type 127, 132 or 133 Power Supply, the Type W can drive recording equipment, X-Y plotters, oscilloscopes, or other indicators.

As a differential input preamplifier, the dynamic range of the W Unit permits common-mode signals up to ± 15 volts in amplitude to be applied to the amplifier without attenuation. With a rejection ratio of 20,000 to 1 for DC or low-frequency signals, signals of 1 mV or less on large common-mode signals can be measured. A front-panel attenuator permits the acceptance of common-mode voltages up to 500 V.

As a differential comparator, voltage measurements using the slide-back technique can be made with this unit. The high accuracy and stability of the DC comparison voltage added differentially to the input signal makes more precise voltage measurements possible. Using this mode of operation, the W Unit has an effective screen height of $\pm 11,000$ cm. This is equivalent to a ± 11 -volt dynamic signal range at a deflection factor of 1 mV/cm. Within this range, calibrated \pm DC comparison voltages can be added differentially to the input signal to permit a maximum of about 0.001% or 100 μ V per mm to be resolved.

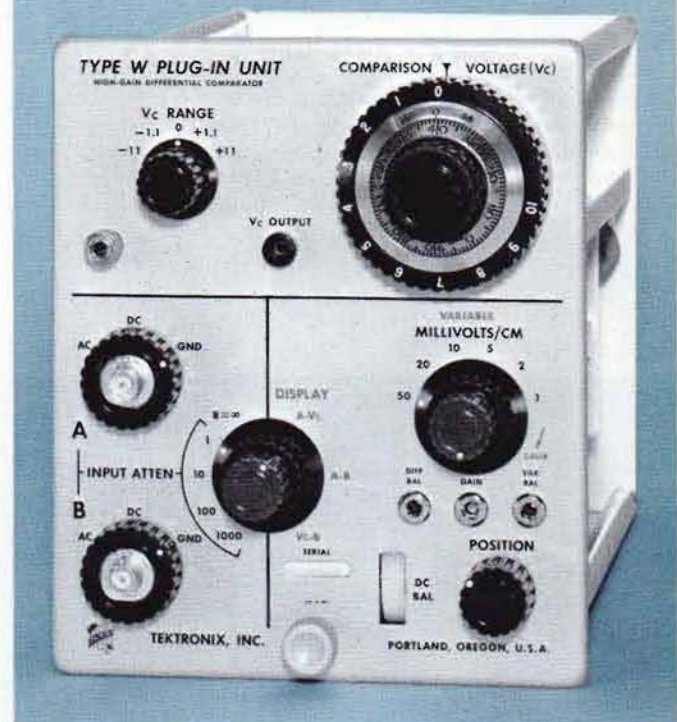

DEFLECTION FACTOR

1 mV/cm to 50 V/cm, determined by millivolts/cm and attenuator settings. Millivolts/cm positions accurate within 3%. Uncalibrated, continuously variable between steps and to approx 125 V/cm.

ATTENUATORS

4 decade steps covering range of 1 to 1,000. 10X position accurate within $\pm 0.05\%$; 100X within $\pm 0.15\%$, 1000X within $\pm 3\%$.

INPUT

1 megohm paralleled by 20 pF (except in additional 1X attenuation position ($R \approx \infty$) where $R > 10,000$ megohm). Input resistance of 10X and 1X attenuators is matched within $\pm 0.1\%$.

NOISE

No more than 300 μ V peak to peak.

CONVENTIONAL PREAMPLIFIER

TYPE W UNIT AND OSCILLOSCOPE	MILLIVOLTS/CM SETTING	BANDWIDTH† (—3 dB)	RISETIME
531A, 533A, 535A	50 1	DC to 13 MHz DC to 7 MHz	27 ns 50 ns
536	50 1	DC to 10 MHz DC to 6.5 MHz	35 ns 54 ns
543B, 544, 545B, 546, 547, 555, 556, 581A*, 585A*	50 1	DC to 23 MHz DC to 8 MHz	16 ns 44 ns
549	50 1	DC to 22 MHz DC to 7 MHz	16 ns 50 ns
551	50 1	DC to 20 MHz DC to 7.5 MHz	18 ns 47 ns

*A Type 81A Adapter is required.

†Low-frequency 3-dB point, AC coupled: 2 Hz, 0.2 Hz with 10X probe.

DIFFERENTIAL-INPUT PREAMPLIFIER

COMMON-MODE REJECTION

At least 20,000:1 at DC to 20 kHz with 30-V peak to peak, DC-coupled. AC COMMON-MODE REJECTION: at least 1000:1 at 60 Hz, with 30-V peak to peak, AC-coupled.

MAXIMUM PEAK INPUT

± 15 volts, increasing to ± 150 volts with 10X attenuation and ± 500 volts with 100X or 1000X attenuation.

HIGH-RESOLUTION VOLTAGE MEASUREMENT using the slide-back technique

A 150-volt sawtooth waveform is applied and clipped with a zener diode, shown in Figure 1. The knee of the curve is shown expanded vertically and horizontally in Figures 2 and 3. This resolution is made possible in the Type W Unit by using the slide-back technique. Figure 3 clearly shows zener noise. 10X more "vertical magnification", to 1 mV/cm, could be used, if desired.

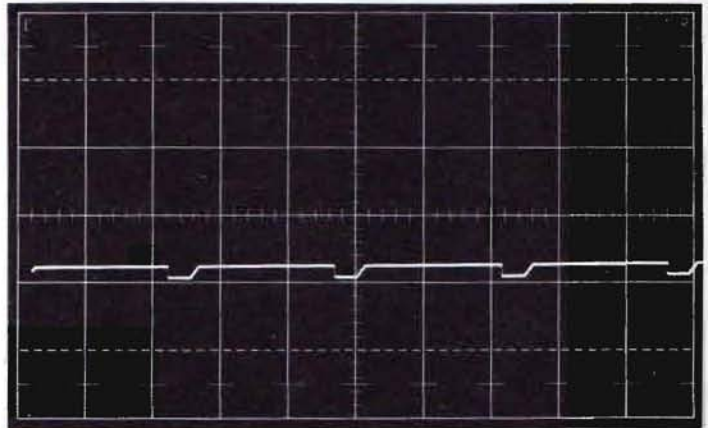

Figure 1—50 V/cm, 5 ms/cm.

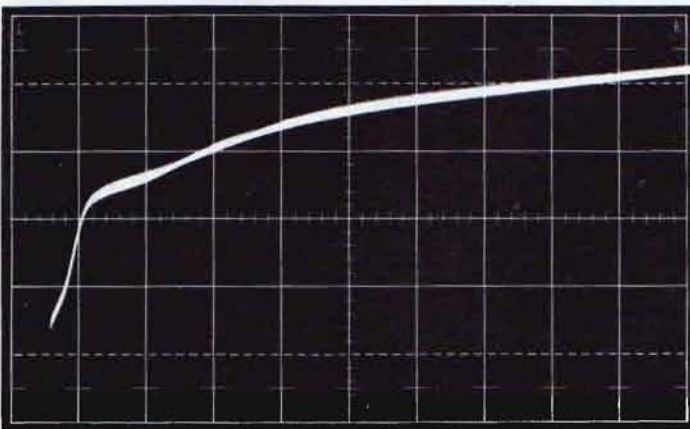

Figure 2—50 mV/cm, 0.2 ms/cm.

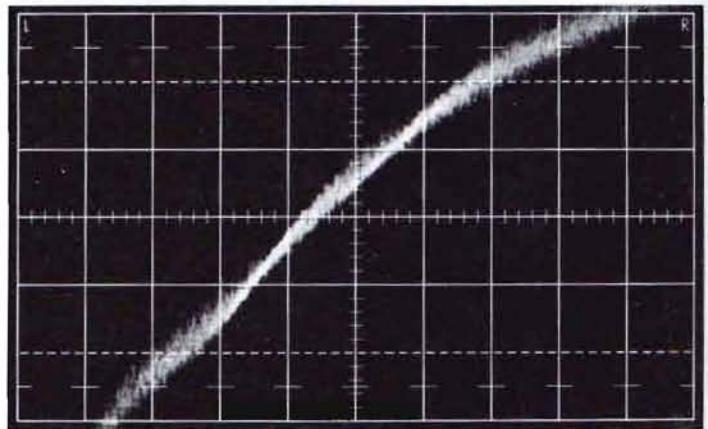

Figure 3—(Single sweep), 10 mV/cm, 100 μ s/cm.

CALIBRATED DIFFERENTIAL COMPARATOR

COMPARISON VOLTAGE

0 to ± 1.1 V, or 0 to ± 11 V. Accuracy: $\pm(0.15\%$ of indicated value plus 0.05% of Vc range).

Vc SUPPLY RESOLUTION

0 to ± 1.1 V range: 100 μ V per minor dial div; 0 to ± 11 V range: 1 mV per minor dial div.

MAXIMUM PEAK INPUT

Same as for Differential-Input.

OVERDRIVE RECOVERY

Recovers to within 10 mV of reference signal within 300 ns after the signal returns to the screen. Certain overdrive signals can cause an additional slow (thermal) shift of up to 5 mV in the reference level.

WEIGHTS

Net weight	5 lb	2.3 kg
Domestic shipping weight	≈ 8 lb	≈ 3.6 kg
Export-packed weight	≈ 12 lb	≈ 5.5 kg

INCLUDED STANDARD ACCESSORIES

Two instruction manuals (070-0432-00).

OPTIONAL ACCESSORIES

The probes recommended for use with this plug-in unit satisfy most measurement requirements. Other probes are available for current and high-voltage measurements. See catalog accessory pages for additional information on these and other items.

P6007 100X Probe Package, order 010-0150-00

P6023 10X Probe Package, adjustable attenuation ratio helps maintain common-mode rejection, order 010-0167-00

P6028 1X Probe Package, order 010-0074-00

Please refer to Terms and Shipment, General Information page.

DC-to-50 MHz DUAL-TRACE UNIT

- 5 mV/CM to 20 V/CM
CALIBRATED DEFLECTION FACTOR
- $\approx 500 \mu\text{V}/\text{CM}$ SINGLE CHANNEL
- CHANNEL 1 SIGNAL & TRIGGER OUTPUTS
- 1-MHz CHOPPING RATE
- SOLID-STATE DESIGN

Type 1A1 provides dual-trace displays in Type 530, 540, 550 and 580* Series Oscilloscopes. Maximum bandwidth is achieved in Type 544, 546, 547, 556, 581A, and 585A Oscilloscopes. Input channels are identical with separate controls for coupling, attenuating, inverting and positioning the signal.

Used with the Type 547 or RM547 Oscilloscopes, the alternate switching circuit can be slaved to the display switching circuit in the oscilloscope, thus locking Channel 1 to Time Base A and Channel 2 to Time Base B. For many applications this provides the equivalent of a dual-beam oscilloscope without the additional complexity and cost.

Solid state components are used throughout except for the output stage.

Type 127, 132, 133 Power Supplies are available to operate the Type 1A1 outside an oscilloscope. See the descriptions of these instruments for details.



TYPICAL BANDWIDTH

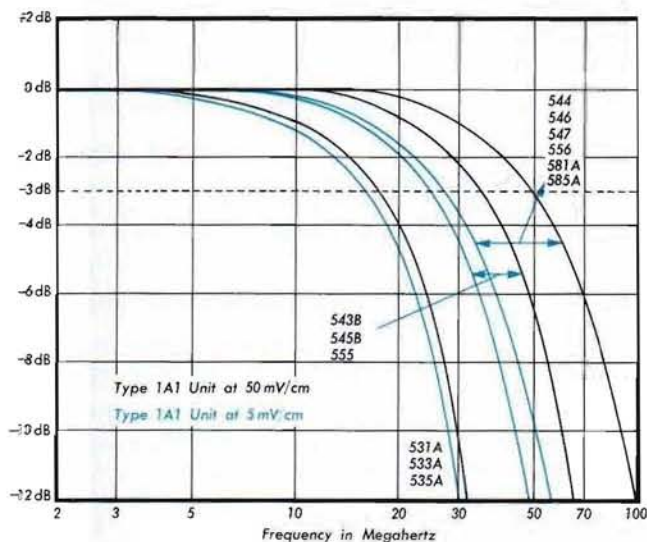

TYPE 1A1 UNIT AND OSCILLOSCOPE	DEFLECTION FACTOR	BANDWIDTH† (-3 dB)	RISE-TIME
531A, 533A, 535A	50 mV/cm	DC to 15 MHz	24 ns
	5 mV/cm	DC to 14 MHz	25 ns
	$\approx 500 \mu\text{V}/\text{cm}$	2 Hz to 10 MHz	35 ns
536	50 mV/cm	DC to 11 MHz	32 ns
	5 mV/cm	DC to 10 MHz	35 ns
	$\approx 500 \mu\text{V}/\text{cm}$	2 Hz to 8 MHz	44 ns
543B, 545B, 555	50 mV/cm	DC to 33 MHz	11 ns
	5 mV/cm	DC to 23 MHz	16 ns
	$\approx 500 \mu\text{V}/\text{cm}$	2 Hz to 14 MHz	25 ns
544, 546, 547, 556, 581A*, 585A*	50 mV/cm	DC to 50 MHz	7 ns
	5 mV/cm	DC to 28 MHz	13 ns
	$\approx 500 \mu\text{V}/\text{cm}$	2 Hz to 15 MHz	24 ns
549	50 mV/cm	DC to 30 MHz	12 ns
	5 mV/cm	DC to 23 MHz	16 ns
	$\approx 500 \mu\text{V}/\text{cm}$	2 Hz to 14 MHz	25 ns
551	50 mV/cm	DC to 27 MHz	13 ns
	5 mV/cm	DC to 21 MHz	17 ns
	$\approx 500 \mu\text{V}/\text{cm}$	2 Hz to 13 MHz	27 ns

*A Type 81A Adapter is required.

†Low-frequency 3-dB point, AC coupled: 2 Hz, 0.2 Hz with 10X probe.

TYPE 1A1

DEFLECTION FACTOR

5 mV/cm to 20 V/cm in 12 calibrated steps (1-2-5 sequence), accurate within 3%. Uncalibrated, continuously variable between steps and to approx 50 V/cm.

INPUT RC

1 megohm paralleled by approx 15 pF.

MAXIMUM INPUT VOLTAGE

600 V combined DC + peak AC.

OPERATING MODES

Either single channel, normal or inverted; algebraic addition; chopped or alternate electronic switching between channels. Alternate: channels switched at the end of each sweep. Chopped: successive 500-ns segments of each channel displayed at an approx 1-MHz rate per channel. Chopped transient blanking except in Type 536, 551, 581A, and 585A Oscilloscopes.

SIGNAL OUTPUT

Channel 1 Output provides up to X10 gain, can be AC coupled into Channel 2 for approx 500 μ V/cm deflection factor. Noise or frequency filters can be inserted between channels if desired. Output impedance is approx 50 Ω . Maximum bandwidth of output alone is DC to 35 MHz; see chart for bandwidths at 500 μ V/cm.

TRIGGER OUTPUT

Channel 1 output for external triggering permits viewing true time relationship between signals in alternate or chopped operation. Output also applied internally to Type 544, 546, 547, 549, 555 (with Types 21A and 22A), and 556 Oscilloscopes. Approx 0.5 V for each centimeter of displayed signal at 1 kHz with calibrated deflection factors.

WEIGHTS

Net weight	5 ³ / ₄ lb	2.6 kg
Domestic shipping weight	≈11 lb	≈5.0 kg
Export-packed weight	≈14 lb	≈6.4 kg

INCLUDED STANDARD ACCESSORIES

BNC-to-BNC 50 Ω cable (012-0076-00), two instruction manuals (070-0378-01).

OPTIONAL ACCESSORIES

The probes recommended for use with this plug-in unit satisfy most measurement requirements. Other probes are available for current and high-voltage measurements. See catalog accessory pages for additional information on these and other items.

P6008** 10X Probe Package, order 010-0129-00

P6009 100X Probe Package, order 010-0140-00

P6028 1X Probe Package, order 010-0074-00

**P6008 10X Probes included with Type 544, 546, 547 and 556 Oscilloscopes increase input resistance to 10 M Ω and decrease input capacitance to approx 7.5 pF. Bandwidth of probe and oscilloscope is 45 MHz or greater; risetime is approx 7 ns.

Please refer to Terms and Shipment, General Information page.

DC-to-50 MHz DUAL-TRACE UNIT

- 50 mV/CM to 20 V/cm
CALIBRATED DEFLECTION FACTOR
- CHANNEL 1 OR 2 TRIGGER OUTPUT
- 220 kHz CHOPPING RATE

Type 1A2 plug-in unit provides dual-trace displays in 530, 540, 550, and 580* Series Oscilloscopes. Unit has identical input channels with separate controls for coupling, attenuating, inverting and positioning the signal. Chopped or alternate electronic switching is used for dual-trace displays.

When the unit is used with Type 547 or RM547 Oscilloscopes, the alternate switching circuit can be slaved to the display switching circuit in the oscilloscope, thus locking Channel 1 to Time Base A and Channel 2 to Time Base B. For many applications this provides the equivalent of a dual-beam oscilloscope without the additional complexity and cost.

Type 127, 132, and 133 Power Supplies are available to operate the Type 1A2 outside an oscilloscope. See the description of these instruments for details.



TYPE 1A2 UNIT AND OSCILLOSCOPE	BANDWIDTH† (-3 dB)	RISETIME
531A, 533A, 535A	DC to 15 MHz	24 ns
536	DC to 11 MHz	32 ns
543B, 545B, 555,	DC to 33 MHz	11 ns
544, 546, 547, 556 581A*, 585A*	DC to 50 MHz	7 ns
549	DC to 30 MHz	12 ns
551	DC to 27 MHz	13 ns

*A Type 81A Adapter is required.

†Low-frequency 3-dB point, AC coupled: 2 Hz, 0.2 Hz with 10X probe.

DEFLECTION FACTOR

50 mV/cm to 20 V/cm in 9 calibrated steps (1-2-5 sequence), accurate within 3%. Uncalibrated, continuously variable between steps and to approx 50 V/cm.

INPUT RC

1 megohm paralleled by approx 15 pF.

MAXIMUM INPUT VOLTAGE

600 V combined DC + peak AC.

OPERATING MODES

Either single channel, normal or inverted; algebraic addition; chopped or alternate electronic switching between channels. Alternate: channels switched at the end of each sweep. Chopped: successive 2- μ s segments of each channel displayed at an approx 220-kHz rate per channel. Chopped transient blanking except in Type 536, 551, 581A, and 585A Oscilloscopes.

COMMON-MODE REJECTION

$\geq 20:1$ throughout full bandwidth for signals up to 0.5 V peak-to-peak (measured at maximum gain).

TRIGGER OUTPUT

Channel 1 or 2 output for external triggering permits viewing true time relationship between signals in alternate or chopped operation. Output also applied internally to Type 544, 546, 547, 549, 555 (with Type 21A and 22A), and 556 Oscilloscopes. At least 0.5 V for each centimeter of displayed signal at 1 kHz with calibrated deflection factors.

WEIGHTS

Net weight	4½ lb	2.0 kg
Domestic shipping weight	≈ 8 lb	≈ 3.6 kg
Export-packed weight	≈ 14 lb	≈ 6.4 kg

INCLUDED STANDARD ACCESSORIES

Two instruction manuals (070-0430-01).

OPTIONAL ACCESSORIES

The probes recommended for use with this plug-in unit satisfy most measurement requirements. Other probes are available for current and high-voltage measurements. See catalog accessory pages for additional information on these and other items.

P6008** 10X Probe Package, order 010-0129-00

P6009 100X Probe Package, order 010-0140-00

P6028 1X Probe Package, order 010-0074-00

**P6008 10X Probes included with Type 544, 546, 547 and 556 Oscilloscopes increase input resistance to 10 M Ω and decrease input capacitance to approx 7.5 pF. Bandwidth of probe and oscilloscope is 45 MHz or greater; risetime is approx 7 ns.

Please refer to Terms and Shipment, General Information Page.

TYPE 1A4

DC-to-50 MHz FOUR-TRACE UNIT

- 10 mV/cm to 20 V/cm DEFLECTION FACTOR
- FOUR-CHANNEL ADDING ($\pm 1 \pm 2$) + ($\pm 3 \pm 4$)
- SIGNAL OUTPUT
- SOLID-STATE DESIGN, FET INPUTS

This plug-in unit for Type 530, 540, 550*, and (with adapter) 580-Series Oscilloscopes through versatile switching logic provides the equivalent of two wide-band, dual-trace units connected to a third wide-band, dual-trace unit. Maximum bandwidth of DC to 50 MHz is achieved with Type 544, 546, 547 and 556 Oscilloscopes. The Type 1A4 provides a new standard of multi-channel versatility in all Tektronix Oscilloscopes that accept Letter-Series or I-Series Plug-In Units.

Unique display logic provides unprecedented display flexibility: any channel can be viewed separately, alternately with any other channel(s), chopped with any other channel(s), added to or subtracted from any other channel(s). Alternate, chopped and added modes can also be used together: for example, Channel 1 added to Channel 2, and the resultant alternated with a chopped display of Channel 3 and 4. Used with Type 547 or RM547 Oscilloscopes, the alternate switching circuit in the plug-in unit can be slaved to the display switching circuit in the oscilloscope. For many applications, this provides the equivalent of a dual-beam oscilloscope, without the added complexity and cost.

The four input channels are identical. Each has separate controls for coupling, attenuating, inverting, positioning, and identifying the signal. Solid-state design, with FET inputs, provides low drift and fast stabilization time.

Type 127, 132, and 133 Power Supplies are available to operate the Type 1A4 outside an oscilloscope. See the description of these instruments for details.

CHARACTERISTICS

TYPE 1A4 UNIT AND OSCILLOSCOPE	BANDWIDTH† (-3 dB)	RISETIME
544, 546, 547, 556, 581A*, 585A*	DC to 50 MHz	7 ns
543B, 545B, 555	DC to 33 MHz	11 ns
549	DC to 30 MHz	12 ns
551	DC to 27 MHz	13 ns
531A, 533A, 535A	DC to 15 MHz	24 ns
536	DC to 11 MHz	32 ns

*A Type 81A Adapter is required.

†Low-frequency 3-dB point, AC coupled; ≤ 2 Hz, ≤ 0.2 Hz with 10X probe.

DEFLECTION FACTOR

10 mV/cm to 20 V/cm in 11 calibrated steps (1-2-5 sequence), accurate within 3%. Uncalibrated, continuously variable between steps and to approx 50 V/cm.

INPUT RC

1 megohm paralleled by approx 20 pF.

MAXIMUM INPUT VOLTAGE

600 V DC + peak AC.

*Early Type 555 Oscilloscopes using Type 21 and 22 Time Base Units require a minor modification.



DISPLAY MODES

Any single-channel; any two channels (alternated, chopped, or added); three channels (alternated, chopped, or added in any combination); and four channels (Channels 1 and 2 alternated, chopped, or added with Channels 3 and 4). Four channel addition is useful in single-shot displays of four different signals, as in delay and coincidence studies.

Channels are always displayed in numerical sequence in chopped and alternate modes. One channel will run twice when only three are turned on. In chopped operation, successive 2.5- μ s (approx) segments of each channel are displayed. Chopping rate is approx 400 kHz. Chopped transient blanking with all oscilloscopes except Type 536, 551, 581A, and 585A.

DISPLAY SWITCHING with Type 547 and RM547 Oscilloscopes

Alternate switching circuit in the Type 1A4 can be slaved to the Automatic Display Switching in Type 547 and RM547 Oscilloscopes to lock Channels 1 and 2 to Time Base A, and Channels 3 and 4 to Time Base B. For dual-trace slaving, Channel 1 or 2 is alternated with Channel 3 or 4. Alternation of up to 8 traces with each signal displayed on 2 different time bases is also possible when the 1A4 is not slaved to the oscilloscope.

COMMON-MODE REJECTION

At least 20:1 for 10 MHz common-mode signals up to 10 cm in amplitude.

CHANNEL ISOLATION

At least 50:1 for signals from DC to 20 MHz.

SIGNAL OUTPUT AND TRIGGER SOURCE

Signal from any channel can be used to externally trigger the oscilloscope, thus indicating the true time relationship between signals displayed in alternate and chopped mode. Selected output also applied internally to Type 544, 546, 547, 549, 555 (with Type 21A and 22A), and 556 Oscilloscopes. The front-panel output can also be cascaded with another channel, providing additional gain useful in many applications. Signal output amplitude is >0.5 V/cm of displayed signal, unterminated at 1 kHz. Bandwidth is ≤ 20 Hz to ≥ 10 MHz (to approx 500 kHz with any channel operated in chopped mode). Approx 50- Ω output impedance.

WEIGHTS

Net weight	6½ lb	3.1 kg
Domestic shipping weight	≈10 lb	≈4.5 kg
Export-packed weight	≈16 lb	≈7.3 kg

INCLUDED STANDARD ACCESSORIES

BNC-to-BNC 18-inch cable (012-0076-00); two instruction manuals (070-0545-00).

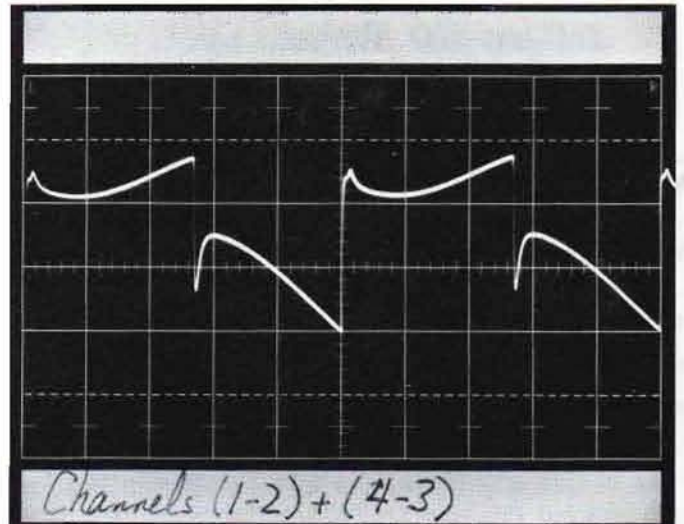

SOME OF MANY POSSIBLE DISPLAY MODES

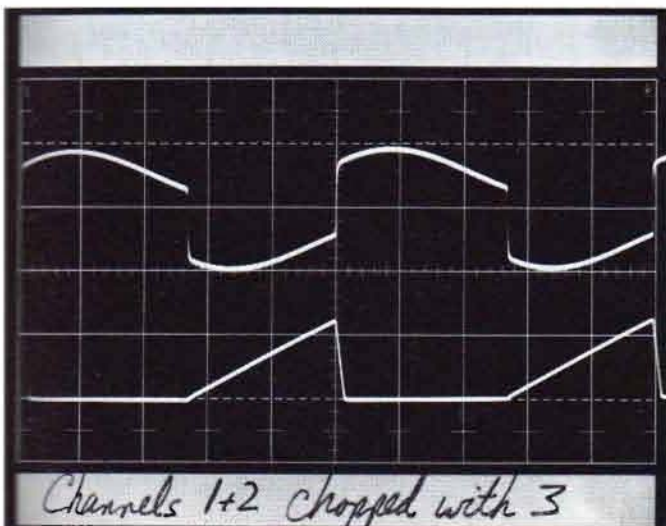
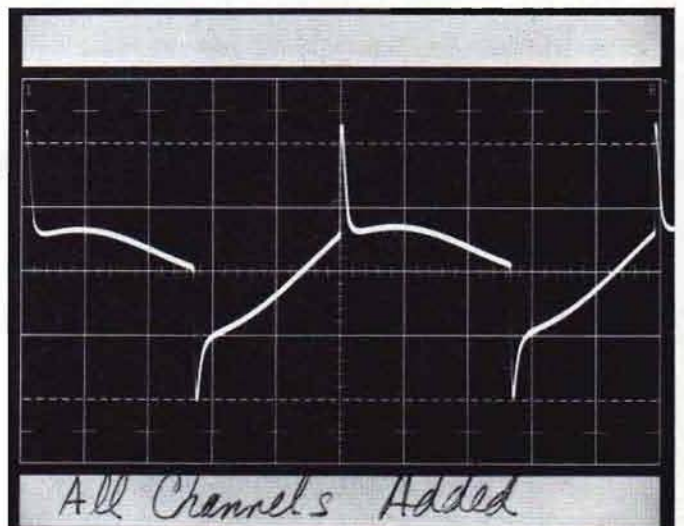
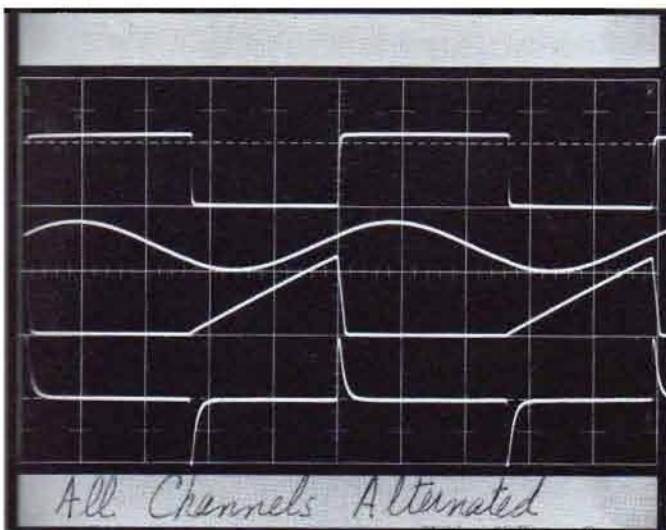

Waveforms photographed with C-12 Camera, Projected Graticule, Type 547 Oscilloscope.

OPTIONAL ACCESSORIES

The probes recommended for use with this plug-in unit satisfy most measurement requirements. Other probes are available for current and high-voltage measurements. See catalog accessory pages for additional information on these and other items.

P6008 10X Probe Package, order 010-0129-00

P6009 100X Probe Package, order 010-0140-00

P6028 1X Probe Package, order 010-0074-00

2 each 10X probes are included standard accessories with Type 530, 540, 550-Series oscilloscopes. Additional probes may be required. Use of the same type probes on all inputs is recommended.

Please refer to Terms and Shipment, General Information page.

TYPE 1A5

DC-to-50 MHz DIFFERENTIAL UNIT

- 1 mV/cm to 20 V/cm
CALIBRATED DEFLECTION FACTOR
- $\geq 10,000:1$ COMMON-MODE REJECTION
FROM DC TO 1 MHz
- LOW DC DRIFT, NON MICROPHONIC
- ± 5 -V COMPARISON VOLTAGE
- SOLID-STATE DESIGN, FET INPUTS

This wide-band differential unit for Type 530, 540, 550, and (with adapter) 580-Series Oscilloscopes achieves a new high in common-mode rejection. Gain-bandwidth products exceed those previously available in a differential amplifier. Maximum bandwidth is obtained with Type 544, 546, 547, 556, 581A*, and 585A* Oscilloscopes. Type 127, 132, and 133 Power Supplies are available to operate the Type 1A5 outside an oscilloscope. See the description of these instruments for details.

Solid state design, with FET inputs, provides low drift and eliminates microphonics.

CHARACTERISTICS

TYPE 1A5 UNIT AND OSCILLOSCOPE	DEFLECTION FACTOR	BANDWIDTH† (-3 dB)	RISE-TIME
544, 546, 547, 556, 581A,* 585A*	5 mV/cm to 20 V/cm 2 mV/cm 1 mV/cm	DC to 50 MHz DC to 45 MHz DC to 40 MHz	7 ns 8 ns 9 ns
543B, 545B, 555	5 mV/cm to 20 V/cm 2 mV/cm 1 mV/cm	DC to 33 MHz DC to 31 MHz DC to 30 MHz	11 ns 12 ns 12 ns
549	5 mV/cm to 20 V/cm 2 mV/cm 1 mV/cm	DC to 30 MHz DC to 29 MHz DC to 28 MHz	12 ns 13 ns 13 ns
551	5 mV/cm to 20 V/cm 2 mV/cm 1 mV/cm	DC to 27 MHz DC to 26 MHz DC to 25 MHz	13 ns 14 ns 14 ns
531A, 533A, 535A	5 mV/cm to 20 V/cm 2 and 1 mV/cm	DC to 15 MHz DC to 14 MHz	24 ns 25 ns
536	1 mV/cm to 20 V/cm	DC to 11 MHz	32 ns

†Low-frequency 3-dB point, AC coupled: ≤ 2 Hz.

*A Type 81A Adapter is required.

DEFLECTION FACTOR

1 mV/cm to 20 V/cm in 14 calibrated steps (1-2-5 sequence), accurate within 2.5% (within 2% from 1 mV/cm to 20 mV/cm). Uncalibrated, continuously variable between steps and to ≥ 50 V/cm.

INPUT RC

1 megohm paralleled by approx 20 pF.

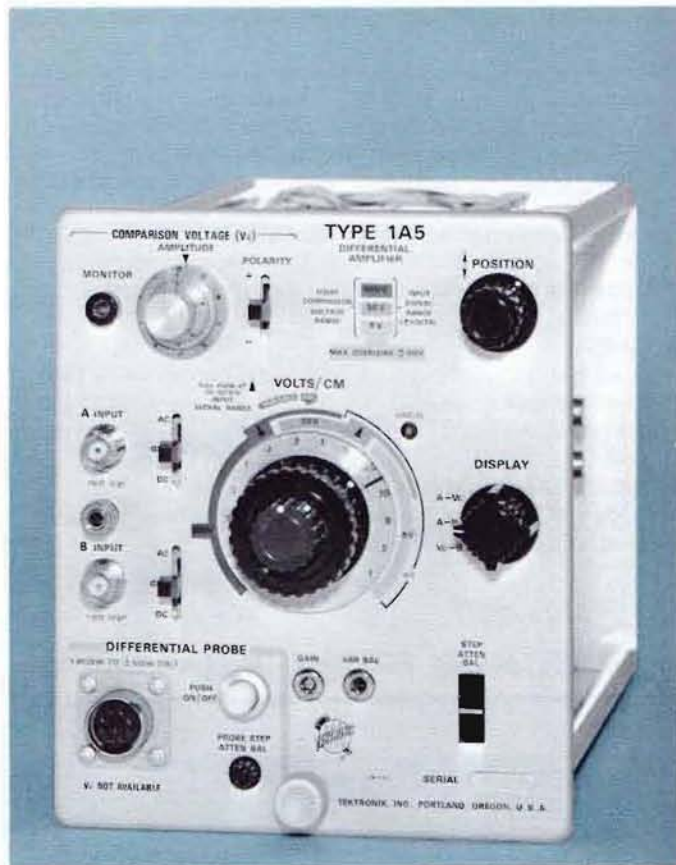

P6046 DC-to-50 MHz DIFFERENTIAL PROBE

INPUT COUPLING

May be switched to AC, GND, or DC. Input coupling capacitor is automatically charged to proper voltage through a 1-megohm resistor when switch is in GND position.

MAXIMUM INPUT VOLTAGE

± 100 V (DC + peak AC) from 1 mV/cm to 20 mV/cm,
 ± 500 V (DC + peak AC) from 10 mV/cm to 20 V/cm.

COMMON-MODE DYNAMIC RANGE

$\geq \pm 5$ V (DC + peak AC) from 1 mV/cm to 20 mV/cm,
 $\geq \pm 50$ V from 50 mV/cm to 0.2 V/cm, $\geq \pm 500$ V from
0.5 V/cm to 20 V/cm. The ± 50 -V range can be extended
from 50 mV/cm to 10 mV/cm, and the ± 500 -V range can
be extended from 0.5 V/cm to 0.1 V/cm by pulling and turn-
ing the V/cm control.

COMMON-MODE REJECTION RATIOS*			
FREQUENCY	REJECTION RATIO	SINEWAVE AMPLITUDE	DEFLECTION FACTOR
DC to 100 kHz	$\geq 20,000:1$	± 5 V P to P	1 mV/cm to 20 mV/cm
100 kHz to 1 MHz	$\geq 10,000:1$	± 5 V P to P	1 mV/cm to 20 mV/cm
1 MHz to 10 MHz	$\geq 10,000:1$ divided by freq. in MHz	± 5 V P to P divided by freq. in MHz	1 mV/cm to 20 mV/cm
DC to 10 kHz	$\geq 2,000:1$	± 50 V P to P	10 mV/cm to 2 V/cm
DC to 10 kHz	$\geq 100:1$	± 50 V P to P	1 V/cm to 20 V/cm
60 Hz (AC coupled)	$\geq 1,000:1$	± 5 V P to P	1 mV/cm to 2 mV/cm

*At 0°C to 50°C

DC DRIFT

With time: $\leq 200 \mu\text{V/h}$ at 25°C. With temperature: $\leq 200 \mu\text{V}/^\circ\text{C}$. With line voltage change: $\leq 300 \mu\text{V}$ from 105 to 125 VAC.

NOISE

$\leq 50 \mu\text{V RMS}$.

DC SHIFT DUE TO OVERDRIVE

$\leq 1\%$ of overdrive signal or ≤ 10 mV, whichever is smaller.

OVERDRIVE RECOVERY

Recovers to within 10 mV of DC-shifted level after 0.3 μs .

COMPARISON VOLTAGE

0 to ± 5 V, internally applied to + input or - input, monitorable at front panel. Accuracy within 7 mV or 0.5% of comparison voltage, whichever is greater.

WEIGHTS

Net weight	5 lb	2.3 kg
Domestic shipping weight	≈ 7 lb	≈ 3.2 kg
Export-packed weight	≈ 13 lb	≈ 5.9 kg

INCLUDED STANDARD ACCESSORIES

Two instruction manuals (070-0638-00).

P6046 DC-to-50 MHz DIFFERENTIAL PROBE

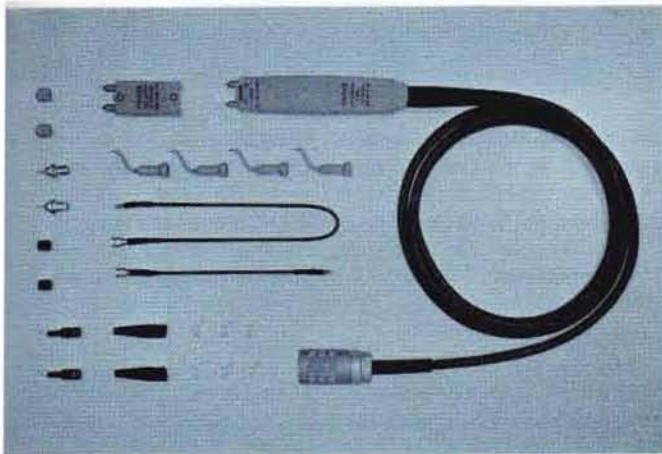

The P6046 expands the differential measurement capabilities of the Type 1A5 Plug-In Unit. With this new probe, the differential-signal-adding takes place in the probe itself, resulting in high common-mode signal rejection at higher frequencies. This differential probe-tip performance minimizes the measurement errors caused by differences in probes, cable lengths, and input attenuators. In addition, the wide-band capability of the P6046 assures DC-to-50 MHz performance at the probe tip where the measurements are made.

CHARACTERISTICS

Probe with Type 1A5 Plug-In Unit

ATTENUATION is 1X.

INPUT RESISTANCE is 1 megohm.

INPUT CAPACITANCE is approx 10 pF.

COMMON-MODE LINEAR DYNAMIC RANGE is ± 5 V (DC + peak AC), ± 50 V with 10X attenuator.

COMMON-MODE REJECTION RATIOS with deflection factors of 1 mV/cm to 20 mV/cm are 10,000:1 at DC, 1,000:1 at 50 MHz.

BANDWIDTH/RISETIME

TYPE 1A5 DEFLECTION FACTOR	BANDWIDTH* (-3 dB)	RISETIME*
200 mV/cm to 5 mV/cm	DC to 50 MHz	7 ns
2 mV/cm	DC to 45 MHz	8 ns
1 mV/cm	DC to 40 MHz	9 ns

*With Oscilloscope Types 544, 546, 547, 556, or 581A, 585A with Type 81A Adapter.

MAXIMUM INPUT VOLTAGE is ± 25 V (DC + peak AC), ± 250 V with 10X attenuator.

NOISE (periodic and random deviation) is 190 μV or less.

THERMAL DRIFT at the probe head is 250 $\mu\text{V}/^\circ\text{C}$ or less.

PROBE CABLE is 6 feet long, terminated with a special nine-pin connector.

P6046 PROBE PACKAGE (010-0213-00)

Please refer to Terms and Shipment, General Information page.

TYPE 1A6

DC-to-2 MHz DIFFERENTIAL UNIT

- 1 mV/CM to 50 V/CM
CALIBRATED DEFLECTION FACTOR
- CONSTANT BANDWIDTH
- 10,000:1 COMMON-MODE REJECTION
- ± 15 V COMMON-MODE SIGNAL RANGE
- SOLID-STATE DESIGN

The Type 1A6 Plug-In Unit is a DC coupled differential amplifier designed for Tektronix 530, 540, 550 and 580* Series Oscilloscopes. It features a differential input with a high rejection ratio for in-phase signals, allowing the cancellation of unwanted or interfering signals. The differential measuring capability is particularly useful in the display of instantaneous voltage difference between signals.

The plug-in unit is simple to operate. Only one control is used to select the deflection factor and the common-mode signal range.

Type 127, 132, and 133 Power Supplies are available to operate the Type 1A6 outside an oscilloscope. See the description of these instruments for details.

CHARACTERISTICS

BANDWIDTH

DC to ≥ 2 MHz (≤ 2 Hz to ≥ 2 MHz AC-coupled) at 3-dB down. Bandwidth independent of deflection factor.

RISETIME

$\leq 0.18 \mu\text{s}$.

DEFLECTION FACTOR

1 mV/cm to 50 V/cm in 15 calibrated steps, 1-2-5 sequence; $\pm 1.5\%$ accuracy from 1 mV/cm to 50 mV/cm, $\pm 2.5\%$ accuracy from 0.1 V/cm to 50 V/cm. Uncalibrated continuous variation between steps and to approx 125 V/cm.

INPUT RC

1 megohm paralleled by 33 pF.

MAXIMUM INPUT VOLTAGE

DC coupled: 1 mV—50 mV, 200 V DC + peak AC.
0.1 V—50 V, 600 V DC + peak AC.

AC coupled: 1 mV—50 mV, 200 V AC peak to peak.
0.1 V—50 V, 600 V DC + peak AC.

INPUT COUPLING

AC, GND, or DC. Input coupling capacitor is automatically charged to proper voltage through a 1-megohm resistor when switch is in GND position.

COMMON-MODE REJECTION

1 mV/cm to 50 mV/cm	0.1 V/cm to 50 V/cm
$\geq 10,000:1$ from DC to 100 kHz	$\geq 1000:1$ from DC to 100 kHz
$\geq 2000:1$ at 60 Hz (AC-coupled)	$\geq 1000:1$ at 60 Hz (AC-coupled)

*A Type 81A Adapter is required.

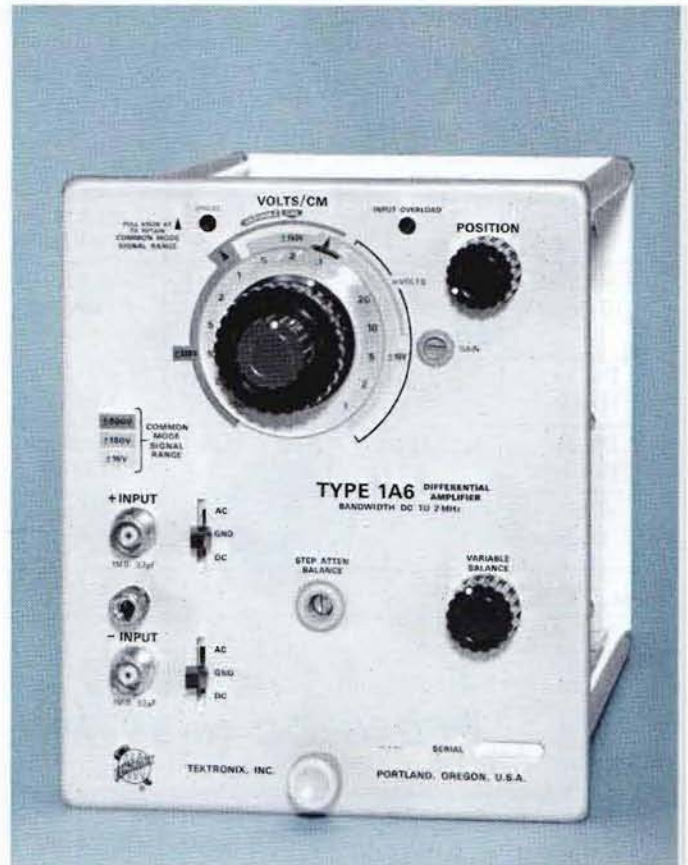

COMMON-MODE DYNAMIC RANGE

± 15 V (combined DC and peak AC) from 1 mV/cm to 50 mV/cm, ± 150 V from 0.1 V/cm to 0.5 V/cm, ± 500 V from 1 V/cm to 50 V/cm. The ± 150 -V range can be extended from 0.1 V/cm to 10 mV/cm, and the ± 500 -V range can be extended from 1 V/cm to 0.1 V/cm by pulling and turning the V/cm control.

WEIGHTS

Net weight	4 $\frac{1}{4}$ lb	1.9 kg
Domestic shipping weight	≈ 8 lb	≈ 3.6 kg
Export-packed weight	≈ 14 lb	≈ 6.4 kg

INCLUDED STANDARD ACCESSORIES

Two instruction manuals (070-0537-00).

OPTIONAL ACCESSORIES

The probes recommended for use with this plug-in unit satisfy most measurement requirements. Other probes are available for current and high-voltage measurements. See catalog accessory pages for additional information on these and other items.

P6007 100X Probe Package, order 010-0150-00

P6023 10X Probe Package, adjustable attenuation ratio helps maintain common-mode rejection, order 010-0167-00

P6028 1X Probe Package, order 010-0074-00

Please refer to Terms and Shipment, General Information page.

NEW

- 10 $\mu\text{V}/\text{cm}$ BASIC DEFLECTION FACTOR
- DC-to-1 MHz BANDWIDTH
- SELECTABLE UPPER AND LOWER —3-dB POINTS
- 100,000:1 COMMON-MODE REJECTION
- INTERNAL DIFFERENTIAL OFFSET
- ALL SOLID-STATE FET INPUTS
- 10 $\mu\text{V}/\text{HOUR}$ DC DRIFT*

CHARACTERISTICS

Designed for use with any Tektronix 530, 540, 550, or (with Type 81A Adapter) 580-Series Oscilloscopes. Used with Type 127, 132 or 133 Power Supply, the Type 1A7A can drive recording equipment, X-Y plotters, oscilloscopes or other indicators.

Type 1A7A characteristics represent a significant improvement from previous performance standards for high gain, differential, DC-coupled amplifiers. DC drift is held to 10 $\mu\text{V}/\text{h}$, long term, without chopper stabilization; displayed noise (tangentially measured) is 16 μV at 10 $\mu\text{V}/\text{cm}$ and 1 MHz, with $\leq 25\text{-}\Omega$ source resistance. Bandwidth is maintained at DC to 1 MHz throughout the deflection factor range of 10 $\mu\text{V}/\text{cm}$ to 10 V/cm. CMRR is at least 100,000:1 from DC to 100 kHz at 10 $\mu\text{V}/\text{cm}$ to 10 mV/cm. DC differential offset provides an internal voltage to cancel residual DC levels or inspect signal components over the full differential dynamic range.

Passband is selectable at both upper and lower 3-dB points for noise attenuation and AC coupling at very low frequency (0.1 Hz).

Input circuitry is protected (fused) against accidental severe overload. A differential overload light indicates overload is being approached.

BANDWIDTH

DC to 1 MHz bandwidth independent of deflection factor. Selectable high and low-frequency 3-dB points.

HIGH-FREQUENCY —3-dB POINTS

1 MHz, 300 kHz, 100 kHz, 30 kHz, 10 kHz, 3 kHz, 1 kHz, 300 Hz and 100 Hz.

LOW-FREQUENCY —3-dB POINTS

0.1 Hz, 1 Hz, 10 Hz, 100 Hz, 1 kHz, and 10 kHz. DC mode is included on this control.

DEFLECTION FACTOR

10 $\mu\text{V}/\text{cm}$ to 10 V/cm in 19 calibrated steps, 1-2-5 sequence, accurate within 2%. Uncalibrated continuous variation between steps and to approx 25 V/cm.

INPUT RC

1 megohm, paralleled by 47 pF.

*With constant temperature. See DC DRIFT specifications.

HIGH GAIN DIFFERENTIAL UNIT

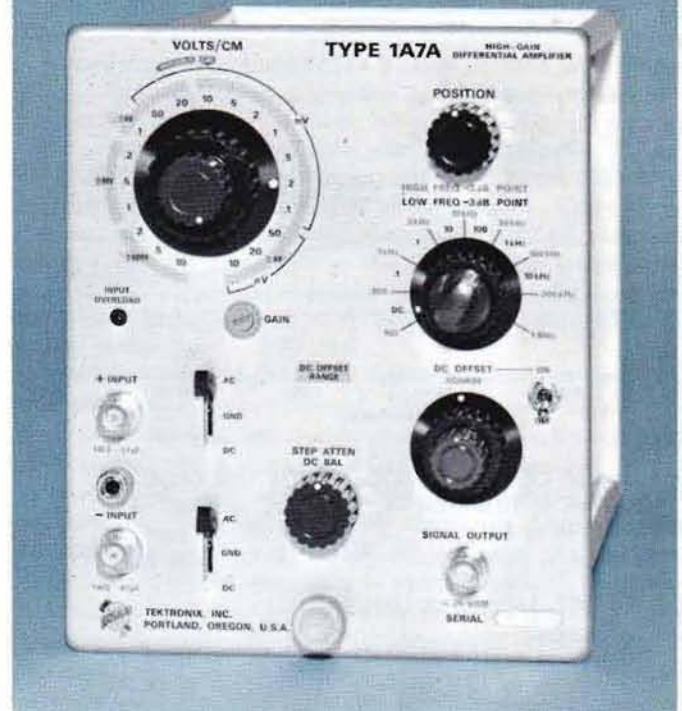

INPUT COUPLING

May be switched to AC, GND, or DC. Input coupling capacitor is automatically charged to proper voltage through a 1-megohm resistor when switch is in GND position. Lower —3-dB point is 1.6 Hz ($\pm 5\%$) when AC coupled at input.

INPUT GATE CURRENT

At 10 $\mu\text{V}/\text{cm}$ to 10 mV/cm, max input gate current is ± 10 pA at $+25^\circ\text{C}$ and ± 100 pA at 50°C . Display change at 10 $\mu\text{V}/\text{cm}$ ($+25^\circ\text{C}$, AC coupled) is ± 1 cm.

DISPLAYED NOISE

≤ 16 μV or 0.1 cm, whichever is greater, measured tangentially at full bandwidth (DC to 1 MHz), source resistance 25 Ω or less. See glossary for definition of "tangential noise measurement".

DC DRIFT

Drift with time (ambient temperature and line voltage constant).

Short term: 5 $\mu\text{V}/\text{minute}$ (P-P) after 1 hour warm up.

Long term: 10 $\mu\text{V}/\text{hour}$ (P-P) after 1 hour warm up.

Drift with ambient temperature (line voltage constant): 50 $\mu\text{V}/^\circ\text{C}$.

DIFFERENTIAL DYNAMIC RANGE

10 $\mu\text{V}/\text{cm}$ to 10 mV/cm — ± 400 mV

20 mV/cm to 0.1 V/cm — ± 4 V

0.2 mV/cm to 1 V/cm — ± 40 V

2 V/cm to 10 V/cm — ± 400 V

TYPE 1A7A

COMMON-MODE REJECTION

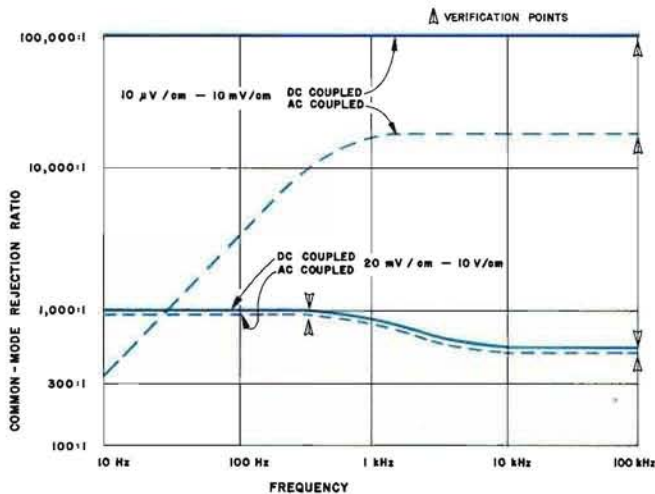

MAXIMUM COMMON-MODE INPUT VOLTAGE

10 $\mu\text{V}/\text{cm}$ to 10 mV/cm — $\pm 10\text{ V DC} + \text{peak AC}$.
 20 mV/cm to 0.1 V/cm — $\pm 100\text{ V DC} + \text{peak AC}$.
 0.2 V/cm to 10 V/cm — $\pm 500\text{ V DC} + \text{peak AC}$.

DC OFFSET (within $\pm 10\%$)

DC Coupled:

10 $\mu\text{V}/\text{cm}$ to 10 mV/cm — $\pm 20\text{ V DC} + \text{peak AC}$
 20 mV/cm to 10 V/cm — $\pm 500\text{ V DC} + \text{peak AC}$

AC Coupled:

10 $\mu\text{V}/\text{cm}$ to 10 V/cm — $\pm 400\text{ V DC peak AC}$

MAXIMUM INPUT VOLTAGE

DC Coupled: 10 $\mu\text{V}/\text{cm}$ to 10 mV/cm — $\pm 20\text{ V/DC} + \text{peak AC}$

20 mV/cm to 10 V/cm — $\pm 500\text{ V DC} + \text{peak AC}$

AC Coupled: 10 $\mu\text{V}/\text{cm}$ to 10 V/cm — $\pm 400\text{ V DC} + \text{peak AC}$

OVERDRIVE RECOVERY

$\leq 10\ \mu\text{s}$ to recover within 0.5% of zero level after removal of a + or - voltage applied for 1 s, applied voltage within the differential dynamic range.

DIFFERENTIAL OVERLOAD LIGHT

Indicates differential overload is being approached.

FRONT-PANEL SIGNAL OUTPUT

0.25 V, $\pm 10\%$, per displayed cm. DC-coupled, internally adjustable to ground reference. $\leq 750\text{-}\Omega$ output impedance. Minimum load resistance, 10 $\text{k}\Omega$.

WEIGHTS

Net weight	4 ³ / ₄ lb	2.1 kg
Domestic shipping weight	≈ 9 lb	≈ 4.1 kg
Export-packed weight	≈ 13 lb	≈ 5.9 kg

INCLUDED STANDARD ACCESSORIES

Two instruction manuals (070-0782-00).

OPTIONAL ACCESSORIES

The probes recommended for use with this plug-in unit satisfy most measurement requirements. Other probes are available for current and high-voltage measurements. See catalog accessory pages for additional information on these and other items.

The P6023 low-capacitance probe is well suited for use with most Tektronix differential units.

The probe can be adjusted to match plug-in unit input capacitance ranging from 20 pF to 50 pF. The X10 attenuation ratio is adjustable over a $\pm 2.5\%$ range to compensate for differences in the input resistance of the plug-in unit. When two P6023 probes are used to drive the two inputs of a differential amplifier, the ability to change the attenuation ratio of one probe versus the other helps to maintain the common-mode rejection ratio of the system.

P6023 10X Probe Package, adjustable attenuation ratio helps maintain common-mode rejection, order 010-0167-00

P6007 100X Probe Package, order 010-0150-00

P6028 1X Probe Package, order 010-0074-00

Please refer to Terms and Shipment, General Information page.

Spectrum Analysis

Spectrum Analyzers are available from Tektronix to satisfy a broad range of measurement requirements and situations. Present users of Tektronix Type 530, 540, 550, 560*, and (with adapter) 580-Series Oscilloscopes can now achieve high-quality spectrum analysis at a fraction of the cost of other analyzers. A plug-in analyzer and oscilloscope offer several advantages over ordinary spectrum analyzers. The oscilloscope's calibrated time base and versatile triggering allow direct measurement of pulse repetition rate and provide stable displays even in the presence of interference. The oscilloscope powers the analyzer, and displays the spectrum on its CRT. Following are listed the Spectrum Analyzer plug-in units with their respective center frequency ranges.

TYPE 1L5 50 Hz-to-1 MHz Analyzer

TYPE 3L5 50 Hz-to-1 MHz Analyzer

TYPE 1L10 1 MHz-to-36 MHz Analyzer

TYPE 3L10 1 MHz-to-36 MHz Analyzer

TYPE 1L20 10-to-4,200 MHz Analyzer

TYPE 1L30 925-to-10,500 MHz Analyzer

The Type 491 is a composite Spectrum Analyzer system. The display and analyzer circuitry is conveniently packaged in an easy-to-carry (38 lb) configuration. For very broadband analysis (up to 40 GHz), constant usage, rack mounting (7 in height), or portable applications, the Type 491 is an ideal instrument. Type 491 10 MHz to 40 GHz Analyzer (see page 47-50).

Typically, the Spectrum Analyzer selects a portion of the electromagnetic spectrum—as wide as 100 MHz, for example—and displays visually on the oscilloscope CRT all the radio activity occurring there. Within the portion of the spectrum that concerns you, any signal, amplitude or frequency modulated, pulsed carriers, etc.—is displayed as a series of "pips" on the CRT. CALIBRATED DISPERSION

*Type 3L5 50-Hz-to-1 MHz center frequency Analyzer and Type 3L10 1-to-36 MHz Analyzer fit Type 561A and Type 564 Oscilloscopes.

SION permits detailed study of the signal, with frequency difference read directly from the CRT. Signals separated by 10 Hz can be resolved with the Type 1L5 or 1L10; signals separated by 1 kHz can be resolved with the Type 1L20, 1L30 or Type 491.

The dynamic range capability of the Tektronix Spectrum Analyzers is greatly increased by the inclusion of square-law and logarithmic detection modes as well as a linear mode. The ability to compress or expand signals enhances the versatility of these instruments. Signals of very nearly the same amplitude can be displayed in the SQUARE-LAW MODE which expands the small difference to a proportion that facilitates measurements. Conversely, signals of greatly different amplitude (40 dB, for example) can be displayed in the LOG MODE which compresses the difference between them. The Analyzers are extremely sensitive and will give usable displays with inputs lower than -100 dBm.

The usefulness of Tektronix Spectrum Analyzers extends into many measurement areas. They are used by government agencies to check the sidebands of radio-transmitting devices. Telephone companies find transmission-line carrier measurements quick and accurate, often providing data not obtainable by other means. Spectrum Analyzers are finding increased use in missile projects and the exploration of outer space, especially in association with the maintenance and trouble-shooting of telemetry equipment. They are indispensable to recently developed techniques of servicing radar and microwave equipment. The Type 1L5 extends spectrum analysis into lower-frequency applications including vibration studies, design of audio equipment, speech therapy, and others. You are encouraged to discuss your measurement and test problems with your Tektronix Field Engineer or Distributor.

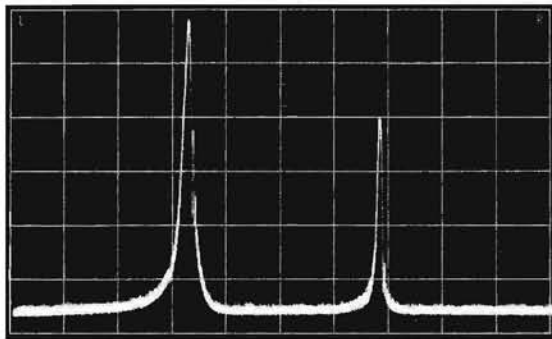

Log Detection Mode

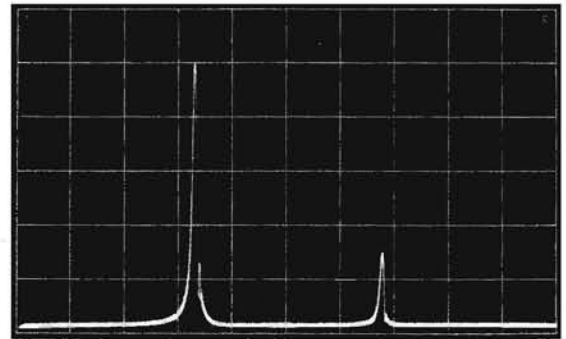

Linear Detection Mode

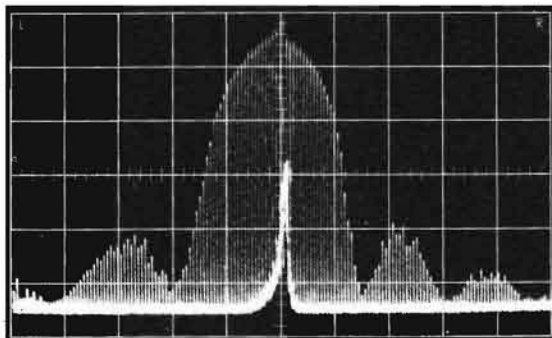

Repetition-Rate lines evident at 5 ms/cm
(Note: CW Feedthrough)

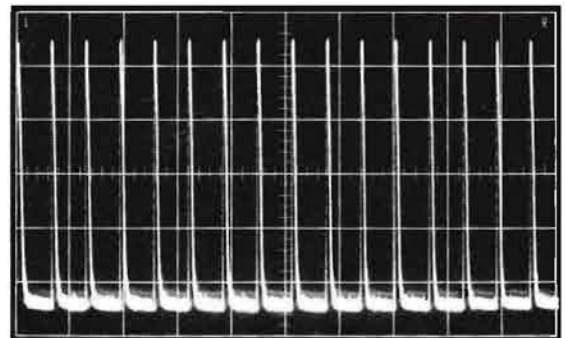

Repetition-Rate measurement at 0.5 ms/cm
Zero Dispersion

TYPE 1L5

50 Hz-to-1 MHz SPECTRUM ANALYZER UNIT

- CALIBRATED VERTICAL DEFLECTION
- CALIBRATED DISPERSION
- 10 Hz TO 1 MHz IN ONE DISPLAY
- TIME-BASED OR FREQUENCY-BASED DISPLAYS
- RECORDER OUTPUT
- SOLID-STATE DESIGN

The Type 1L5 operates over a center-frequency range of 50 Hz to 1 MHz, and provides accurate spectral and time-based displays from 10 Hz to 1 MHz. Calibrated volts/cm and Hz/cm controls make the Type 1L5 as easy to use as the Type 530, 540, 550 or (with adapter) 580-Series Oscilloscopes in which it operates.

Resolution bandwidth extends from 10 Hz to 500 Hz. High-resolution spectral displays can be viewed in their entirety (even at the very slow sweep rates required for maximum resolution) with the Type 549 Storage Oscilloscope. Stored displays can also be compared with subsequent displays, and can be easily photographed for permanent record.

Applications include vibration studies, waveform analysis, and noise measurements.

SPECTRAL DISPLAYS

CENTER FREQUENCY RANGE

50-Hz to 990-kHz, calibrated in 10-Hz, 100-Hz, 1-kHz and 10-kHz steps. Continuously variable to at least 1 MHz.

CENTER FREQUENCY	ACCURACY
50 Hz to 990 Hz	$\pm(5\% + 50 \text{ Hz} + 50 \text{ Hz}/^\circ\text{C change})$
1000 Hz to 9900 Hz	$\pm(5\% + 100 \text{ Hz} + 100 \text{ Hz}/^\circ\text{C change})$
10 kHz to 99 kHz	$\pm(5\% + 3 \text{ kHz} + 200 \text{ Hz}/^\circ\text{C change})$
100 kHz to 990 kHz	$\pm(5\% + 10 \text{ kHz} + 200 \text{ Hz}/^\circ\text{C change})$

DEFLECTION FACTOR

10 $\mu\text{V}/\text{cm}$ to 2 V/cm in calibrated RMS steps (1-2-5 sequence), accurate within 3% (within 6% from 10 $\mu\text{V}/\text{cm}$ to 500 $\mu\text{V}/\text{cm}$) for linear displays. Uncalibrated control provides continuous variation between steps, reduces gain by a factor of approx 3.

CALIBRATED DISPERSION

10 Hz/cm to 100 kHz/cm in 9 steps. Accuracy at center frequencies of 50 Hz to 9900 Hz within 10% at 25° $\pm 5^\circ\text{C}$, within 20% at 25° $\pm 25^\circ\text{C}$; accuracy at center frequencies of 10 kHz to 990 kHz within 15% at 25° $\pm 25^\circ\text{C}$. Linearity within 3%.

COUPLED RESOLUTION

≤ 10 Hz to ≥ 500 Hz, coupled with calibrated dispersion positions and separately switchable.



DISPLAY FLATNESS

± 0.5 dB from 10 Hz to 1 MHz, at most deflection factors; +0.5 dB, -3 dB at 1 mV/cm and 2 mV/cm (or 10 $\mu\text{V}/\text{cm}$ and 20 $\mu\text{V}/\text{cm}$ with $\div 100$ switch pulled).

NOISE

$\leq 5 \mu\text{V RMS}$.

INCIDENTAL FM

≤ 3 Hz from 50 Hz to 9900 Hz; ≤ 10 Hz from 9900 Hz to 990 kHz.

DYNAMIC RANGE

≥ 60 dB in LOG (uncalibrated) mode.

INTERMODULATION DISTORTION

> 50 -dB below reference signals.

RECORDER OUTPUT

5 to 15 mV for 6-cm display, into 600- Ω load, 600- Ω source resistance, DC coupled.

LOCAL OSCILLATOR OUTPUT

Must sweep ≥ 1 MHz from ≈ 3 MHz to ≈ 2 MHz; ≥ 1 V peak to peak.

SWEEP MODES

Manual, internal and external. Accuracy of frequency measurements can be increased using manual scan and monitoring the local oscillator output with a frequency counter. Type 549 Storage Oscilloscope and Type 556 Dual-Beam Oscilloscope provides an internally-coupled sweep to the Analyzer; external input is used with other oscilloscopes.

TIME-BASED DISPLAYS

BANDWIDTH

10 Hz to 1 MHz at most deflection factors; 10 Hz to 700 kHz at 0.1 V/cm and 0.2 V/cm (or 1 mV/cm and 2 mV/cm with $\div 100$ switch pulled).

DEFLECTION FACTOR

1 mV/cm to 100 V/cm in calibrated P to P steps (1-2-5 sequence), accurate within 3% (within 6% from 5 V/cm to 100 V/cm). Uncalibrated control provides continuous variation between steps, reduces gain by a factor of approx 3.

INPUT

1 megohm paralleled by approx 30 pF.
300 V DC + peak AC maximum input voltage.

OTHER CHARACTERISTICS

WEIGHTS

Net weight	6 lb	2.7 kg
Domestic shipping weight	≈ 10 lb	≈ 4.5 kg
Export-packed weight	≈ 18 lb	≈ 8.2 kg

INCLUDED STANDARD ACCESSORIES

1X probe (010-0193-00), banana-to-banana cable (012-0031-00), BNC-to-banana cable (012-0091-00), plug (134-0052-00), plug protector (134-0076-00), two instruction manuals (070-0600-00).

OPTIONAL ACCESSORIES

The standard 1X probe supplied with the analyzer satisfies most measurement requirements. Optional probes may be better suited for particular applications. See catalog accessory pages for additional information on these and other items.

P6007 100X Probe Package, order 010-0150-00

P6012 10X Probe Package, order 010-0203-00

600 Ω Termination (BNC), order 011-0092-00

Please refer to Terms and Shipment, General Information page.

TYPE 1L10

1-to-36 MHz SPECTRUM ANALYZER UNIT

- CALIBRATED DISPERSION
- COUPLED RESOLUTION
- CRYSTAL-CONTROLLED SWEEP OSCILLATOR
- IMAGE REJECTION
- RECORDER OUTPUT

1 to 36-MHz spectral displays can now be viewed on any Tektronix Type 530, 540, 550 or (with adapter) 580-Series Oscilloscope. The Type 549 Oscilloscope adds further convenience to spectrum analysis—allowing storage and simultaneous comparison of special displays.

CALIBRATED DISPERSION from 10 Hz/cm to 2 kHz/cm makes frequency measurement as easy and accurate as time measurement. Frequency differences can be read directly from the CRT. The **SEARCH MODE** permits rapid location of signals for analysis.

COUPLED RESOLUTION from 10 Hz to 1 kHz greatly simplifies operation, providing narrow resolution bandwidth at narrow dispersion and wide resolution bandwidth at wide dispersion. Dispersion and resolution controls can be uncoupled and operated separately if desired, for optimized viewing of a particular signal.

IF stability is achieved through use of **CRYSTAL-CONTROLLED OSCILLATORS**. Even the swept local oscillator is controlled through a crystal discriminator. An external, front-end crystal-operated oscillator can be connected through a front-panel patch arrangement to provide added stability to spectral displays within or outside the normal 1 to 36-MHz range of the Type 1L10.

IMAGE REJECTION is achieved through use of a 60-MHz first IF amplifier which places images at more than twice the upper tuning frequency of the Type 1L10.

FREQUENCY RANGE

1 to 36 MHz, fine and coarse tuning.

MINIMUM CW SENSITIVITY (50 Ω INPUT)

-100 dBm, measured at 2 kHz/cm dispersion and 1 kHz (coupled) resolution.

DIAL ACCURACY

±(100 kHz + 1% of dial reading).

CALIBRATED DISPERSION

0.01 kHz/cm to 2 kHz/cm, 8 steps, 1-2-5 sequence.

Accuracy within ±3% when adjusted for individual oscilloscope, within ±7% without adjustment. Dispersion linearity within ±5%. Search position (uncalibrated)—minimum 20 kHz + 1 kHz/MHz dial frequency full scale (10 cm).

COUPLED RESOLUTION

10 Hz to 1 kHz, coupled with calibrated dispersion positions, and separately switchable. Search position—approximately 10 kHz.

DISPLAY FLATNESS

±1 dB.

MAXIMUM INCIDENTAL FM

IF within 5 Hz.

LO within 25 Hz + 1 Hz/MHz dial frequency.



INPUT IMPEDANCE

Approx 50 Ω and approx 600 Ω.

MAXIMUM INPUT POWER

+24 dBm at full RF attenuation, -20 dBm without RF attenuation.

RF ATTENUATOR

51 dB ± 0.1 dB/dB in 1-dB steps.

½ watt maximum power-handling capability.

IF GAIN CONTROL

>60 dB range.

VERTICAL DISPLAY (6 cm)

Log—50-dB dynamic range.

Linear—26-dB dynamic range.

Linear X10—26-dB dynamic range.

Video—100 mV/cm (variable), ≤16 Hz to ≥10 MHz, approx 50-Ω input resistance.

RECORDER OUTPUT

DC-coupled, approx 600-Ω source resistance, 15 mV/cm display in Linear mode, output linear with voltage.

WEIGHTS

Net weight	6 lb	2.7 kg
Domestic shipping weight	≈11 lb	≈5.0 kg
Export-packed weight	≈18 lb	≈8.2 kg

INCLUDED STANDARD ACCESSORIES

Cable assembly, BNC to BNC, 2½ inches (012-0097-00); cable assembly, BNC to banana plug, 24 inches (012-0096-00); fimi-plug (134-0052-00); two instruction manuals (070-0510-00).

Please refer to Terms and Shipment, General Information page.

MULTI-BAND SPECTRUM ANALYZER UNITS



Type 1L20 covers 10 MHz to 4.2 GHz

- **INTERNAL PHASE LOCK**
- **CALIBRATED DISPERSION TO 100 MHz**
- **COUPLED RESOLUTION**
- **±1.5 dB DISPLAY FLATNESS**
- **RECORDER OUTPUT**

Type 1L30 covers 925 MHz to 10.5 GHz

New operating convenience and state-of-the-art performance is now offered in multi-band plug-in units for all present Tektronix Type 530, 540, 550, or (with adapter) 580-Series Oscilloscopes. The Type 549 Oscilloscope adds further convenience to spectrum analysis—allowing storage and simultaneous comparison of spectral displays.

BUILT-IN PHASE LOCK circuit synchronizes the analyzer local oscillator with a stable reference frequency (internal 1 MHz or external 1 to 5 MHz). When the local oscillator is locked in phase to the reference frequency, the local oscillator stability approaches that of the reference frequency. This allows very narrow dispersion at high frequencies where the analyzer would normally be limited by oscillator drift, microphonics, and other perturbations. Phase lock can be used to view any signal within the tuning range of the analyzer.

CALIBRATED DISPERSION from 1 kHz/cm to 10 MHz/cm makes frequency measurement as easy and accurate as time measurement. Frequency differences can be read directly from the CRT.

COUPLED RESOLUTION from 1 kHz to 100 kHz greatly simplifies operation, providing narrow resolution bandwidth at narrow dispersion and wide resolution bandwidth at wide dispersion. Dispersion and resolution controls can be uncoupled and operated separately if desired, for optimized viewing of a particular signal.

TYPE 1L20 1L30

TYPE	BAND	FREQUENCY RANGE	MINIMUM CW SENSITIVITY*	
			1-kHz RESOLUTION	100-kHz RESOLUTION
1 L 2 0	1	10 MHz to 275 MHz	≥ -100 dBm	≥ -80 dBm
	2	275 MHz to 900 MHz	≥ -110 dBm	≥ -90 dBm
	3	850 MHz to 2 GHz	≥ -100 dBm	≥ -80 dBm
	4	1.95 GHz to 3.1 GHz	≥ -95 dBm	≥ -75 dBm
	5	3 GHz to 4.2 GHz	≥ -90 dBm	≥ -70 dBm
1 L 3 0	1	925 MHz to ≈ 2 GHz	≥ -105 dBm	≥ -85 dBm
	2	≈ 2 GHz to 4.1 GHz	≥ -100 dBm	≥ -80 dBm
	3	4.1 GHz to 6.25 GHz	≥ -95 dBm	≥ -75 dBm
	4	6.2 GHz to 8.4 GHz	≥ -90 dBm	≥ -70 dBm
	5	8.3 GHz to 10.5 GHz	≥ -75 dBm	≥ -55 dBm

*Signal + noise = 2X noise

DIAL ACCURACY

\pm (2 MHz + 1% of dial reading).

CALIBRATED DISPERSION

1 kHz/cm to 10 MHz/cm in 1-2-5 sequence, 2 ranges (kHz/cm—MHz/cm). Accuracy of 10-cm display, throughout full range of IF center frequency control, within $\pm 3\%$ except at 2 MHz/cm ($\pm 5\%$) and 1 MHz/cm ($\pm 7\%$). Accuracy can be increased using internal 1-MHz crystal markers for calibration. Dispersion linearity within $\pm 3\%$. Zero dispersion useful for PRF measurements.

COUPLED RESOLUTION

1 kHz to 100 kHz, coupled with calibrated dispersion positions but separately switchable.

DISPLAY FLATNESS

± 1.5 dB for ± 50 MHz from center frequency, except for ± 25 MHz from center frequency on Band 1 of the Type 1L20.

INCIDENTAL FM

Less than 300 Hz at fundamental, with Phase Lock.

PHASE LOCK

Internal 1-MHz reference accurate within 0.01%. External input accepts 1-MHz to 5-MHz signals from 1 V to 5 V peak to peak.

INPUT IMPEDANCE

Approx 50 Ω .

MAXIMUM INPUT POWER

-30 dBm for linear operation, $+15$ dBm (25 mW) safe diode power limit.

IF ATTENUATOR

51 dB in 1-dB steps, ± 0.1 dB/dB.

IF GAIN CONTROL

> 50 dB range.

IF CENTER FREQUENCY

± 25 MHz adjustment of center frequency from 5 MHz/cm to 0.2 MHz/cm dispersion positions, ± 2.5 MHz adjustment from 500 kHz/cm to 1 kHz/cm dispersion positions.

VERTICAL DISPLAY (6 cm)

Log— ≥ 40 -dB dynamic range.

Linear— ≥ 26 -dB dynamic range.

Square Law— ≥ 13 -dB total dynamic range.

Video— ≤ 16 Hz to ≥ 10 MHz, approx 50- Ω input resistance.

RECORDER OUTPUT

2 mV/cm to 3 mV/cm with linear display, DC-coupled, approx 600- Ω source resistance.

WEIGHTS

Net weight	7½ lb	3.4 kg
Domestic shipping weight	≈ 14 lb	≈ 6.4 kg
Export-packed weight	≈ 20 lb	≈ 9.1 kg

INCLUDED STANDARD ACCESSORIES

Patch cord, BNC to banana (012-0091-00); plug protector (134-0076-00); tini-plug (134-0052-00); two instruction manuals (070-0519-00 for Type 1L20, 070-0520-00 for Type 1L30).

OPTIONAL ACCESSORIES

Attenuators are all supplied with Type N fittings. See accessory section for adapters for other series. Frequency range is DC to 12.4 GHz. Power rating is 2 W average, 300 W peak. Impedance is 50 Ω .



10-dB attenuator, order 011-0085-00

20-dB attenuator, order 011-0086-00

40-dB attenuator, order 011-0087-00

Please refer to Terms and Shipment, General Information page.

350-ps SAMPLING UNIT

- **DC-to-1 GHz BANDWIDTH**
- **2 mV/CM to 200 mV/CM DEFLECTION FACTOR**
- **INTERNAL TRIGGERING**
- **100 ps/CM to 50 μ s/CM CALIBRATED TIME BASE**

Used with any of the Type 530, 540, 550 or 580*-Series Oscilloscopes, the Type 1S1 Sampling Unit extends the measuring capabilities to 1 gigahertz. Operation is like a conventional oscilloscope—but with a combination of bandwidth and sensitivity possible only through sampling.

The Type 1S1 features internal triggering with a built-in delay line—no need for pretriggers or external delay lines. The tunnel-diode trigger circuit assures stable triggering through 1 gigahertz. Calibrated sweep range is from 100 ps/cm to 50 μ s/cm. A single control is used to select the sweep range and magnify the display up to X100 when desired. This single-control feature allows direct read-out of the sweep time/cm even when magnified.

Calibrated vertical deflection factors range from 2 mV/cm to 200 mV/cm. Noise in the display is less than 1 mV, and can be reduced by a smoothing control. A DC-offset control permits observation of millivolt signals in the presence of up to ± 1 volt input levels. Output signals are available at the front panel for driving chart recorders.



VERTICAL SYSTEM

RISETIME

Less than or equal to 350 ps.

BANDWIDTH

Equivalent to DC-to-1 GHz at 3-dB down.

DEFLECTION FACTOR

2 mV/cm to 200 mV/cm in 7 calibrated steps, 1-2-5 sequence. Each step accurate within 3%. Variable between steps, extending to 500 μ V/cm, uncalibrated.

RANDOM NOISE

Equivalent to an input signal of 1 mV or less, unsmoothed; 500 μ V, smoothed (tangentially-measured).

INPUT CHARACTERISTICS

Nominally 50 Ω . Safe overload is ± 5 V. GR874 input connectors. Trigger input is BNC, nominally 50 Ω .

DC OFFSET RANGE

+1 V to -1 V. Allows signals between +1 V and -1 V limits to be displayed at 2 mV/cm. Signals between +2 V and -2 V limits may be displayed at 200 mV/cm. Monitor jacks provide 10X actual DC offset through 10 k Ω .

VERTICAL OUTPUT

200 mV for each centimeter of displayed signal through 10 k Ω .

PROBE POWER

Available at front-panel connector for cathode-follower probe, Type 281 TDR Pulser, and Type 282 Adapter for high-impedance probes.

HORIZONTAL SYSTEM

TIME BASE

50 μ s/cm to 100 ps/cm in 18 calibrated steps, 1-2-5 sequence. Each step accurate within 3%. Variable between steps.

MAGNIFIER

Displays at sweep rates from 1 ns/cm to 50 μ s/cm can be magnified up to X100 (depending on sweep rate) while maintaining a constant number of samples/cm and the same Time Position Range. Magnification occurs from a fixed time-reference point at the left end of the trace.

TIME POSITION RANGE

500 μ s, 50 μ s, 5 μ s, 500 ns and 50 ns, depending on unmagnified TIME/CM setting. Coarse and fine TIME POSITION controls position start of the display through a time interval equal to the TIME POSITION RANGE setting.

SAMPLES/CM

Continuously variable adjustment of samples displayed per centimeter horizontally from approximately 5 samples/cm to an immeasurable number. Allows optimum adjustment of display rate and dot density.

DISPLAY MODES

Repetitive, single display, manual scan, or external scan. Front-panel START button for single-display operation.

INTERNAL DELAY LINE

Permits viewing the leading edge of the input waveform.

*A Type 81A Adapter is required.

TYPE 1S1

TRIGGERING

SOURCE (AC-Coupled): Internal, trigger pickoff in signal channel delivers approximately 1/7 of the input signal amplitude; External, 50- Ω terminated input. **AMPLITUDE (EXT):** Sinewaves, 10 mV to 400 mV, peak-to-peak; Pulses, 5 mV, either polarity. 2 V max DC. **REPETITION RATE:** Sinewave triggering or synchronizing from 100 kHz through 1 GHz. Pulse triggering from 10 Hz through 1 GHz. **JITTER:** Depends on signal shape, repetition rate and amplitude; ≤ 40 ps under optimum conditions.

HORIZONTAL OUTPUT

1 V per displayed centimeter; 10 k Ω source impedance.

WEIGHTS

Net weight	7 $\frac{3}{4}$ lb	3.5 kg
Domestic shipping weight	≈ 17 lb	≈ 7.7 kg
Export-packed weight	≈ 25 lb	≈ 11.4 kg

INCLUDED STANDARD ACCESSORIES

5-ns 50- Ω RG58 cable, GR connectors (017-0512-00); 5-ns 50- Ω RG58 cable, BNC connectors (012-0057-01); 10X 50- Ω attenuator, GR connectors (017-0078-00); 10X 50- Ω attenuator, BNC connectors (011-0059-00); 18-inch patch cord, banana con-

nectors (012-0039-00); 18-inch patch cord, BNC-banana plugs (012-0090-00); GR-to-BNC female adapter (017-0063-00); GR-to-BNC male adapter (017-0064-00); two instruction manuals (070-0475-00).

OPTIONAL ACCESSORIES

TYPE 281 TDR PULSER, order 015-0060-00

TYPE 282 PROBE ADAPTER, order 015-0074-00

P6034 10X Probe, order 010-0110-00

P6035 100X Probe, order 010-0111-00

P6040/CT-1 CURRENT PROBE, order 015-0041-00

VP-1 VOLTAGE PICKOFF, order 017-0073-00

POWER DIVIDER GR 874-TPD, order 017-0082-00

COUPLING CAPACITOR, GR 874-K, order 017-0028-00

This represents only a partial listing of the many useful items available for sampling systems. Please refer to the catalog accessory section for a more complete listing.

Please refer to Terms and Shipment, General Information page.

THE WAVEFORM PHOTOGRAPHS BELOW ILLUSTRATE THE PERFORMANCE CAPABILITIES OF THE TYPE 1S1 SAMPLING UNIT. THESE INCLUDE LOW INHERENT DISPLAY NOISE, STABLE TRIGGERING AND REAL-TIME SAMPLING.

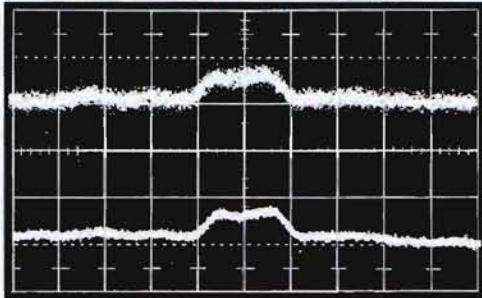

TANGENTIAL NOISE—A 1-mV, 2-ns wide pulse externally triggered. Upper waveform is unsmoothed. The lower is smoothed. Vert: 2 mV/cm. Horiz: 1 ns/cm.

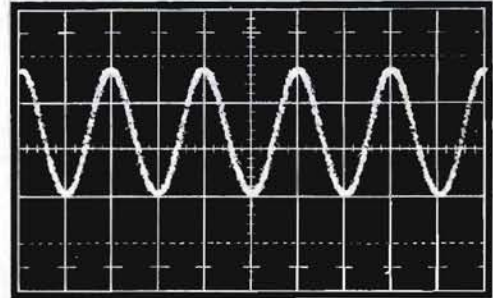

TRIGGERING AT 1 GHz—A 1-GHz sinewave; internally triggered. Vert: 100 mV/cm. Horiz: 0.5 ns/cm.

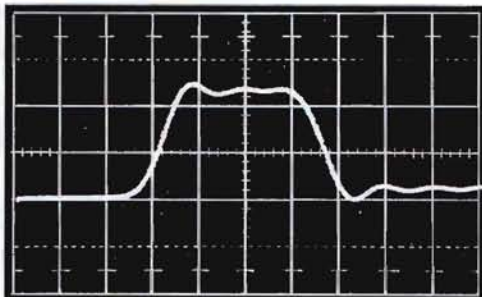

PULSE TRIGGERING—A 50-mV, 2-ns wide pulse; internally triggered. Vert: 20 mV/cm. Horiz: 0.5 ns/cm.

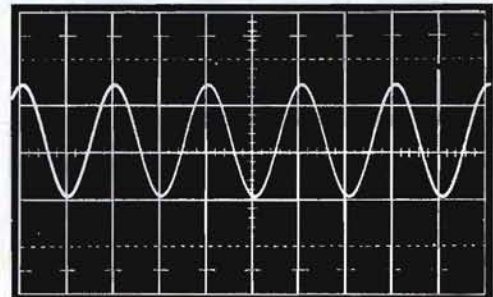

REAL-TIME SAMPLING DISPLAY—A 1-kHz sinewave; Internal Main Frame triggering. Vert: 100 mV/cm (free running sampler). Horiz: 0.5 ms/cm (realtime—main frame).

REFLECTOMETER & SAMPLING UNIT



- 140-ps TDR SYSTEM RISETIME
- 90-ps SAMPLING RISETIME
- RHO AND VOLTAGE CALIBRATION
- TWO INTERNAL PULSE SOURCES

The Type 1S2 Sampling Plug-in converts any Tektronix 530, 540, or 550-series oscilloscope to a time-domain reflectometry measurement system. As a TDR, the Type 1S2 has a system risetime of 140 ps and is calibrated in rho (ρ) from 0.005 ρ /div to 0.5 ρ /div. The horizontal is calibrated from 1 cm/div to 100 m/div for dielectrics of air, TFE and polyethylene. Two pulse outputs provide either 50 ps t_r , 250 mV into 50 Ω , or 1 ns t_r , 1 V into 50 Ω .

The 90-ps risetime, 5 mV/div deflection factor, 100 ps/div sweep and built-in triggering capability make the Type 1S2 useful for many other sampling measurements.

SYSTEM PERFORMANCE AS REFLECTOMETER VERTICAL

SYSTEM RISETIME

Less than or equal to 140 ps, for the displayed reflection from a short-circuited 20-cm air line.

VERTICAL SCALE

Calibrated in ρ (rho) and volts: 0.005 ρ /div to 0.5 ρ /div or 5 mV/div to 500 mV/div in 7 calibrated steps (1-2-5 sequence), accurate within 3%. Continuous variation between steps, uncalibrated.

RESOLUTION

Reflection coefficients as small as 0.001 can be observed.

INPUT CHARACTERISTICS

Nominal 50- Ω feed-through signal channel, (termination supplied). GR874 connectors.

DC OFFSET RANGE

+2 ρ to -2 ρ (or +2 V to -2 V). Allows open-circuit reflections to be displayed at full sensitivity. Actual DC offset may be monitored at 1 ρ /V through 10 k Ω .

VERTICAL OUTPUT

1 V for each division of displayed signal through 10 k Ω .

HORIZONTAL

HORIZONTAL SCALE

Calibrated in distance and time: full-scale, 10-div display (without magnification) of 10 m, 100 m, or 1 km; 100 ns, 1 μ s, or 10 μ s. Accuracy is $\pm 3\%$ with or without magnification.

MAGNIFIER

X1 to X100 in 7 calibrated steps (1-2-5 sequence). Continuously variable between steps. Allows display to be magnified from a fixed on-screen reference point, 1 major division from the left edge of the graticule.

UNITS/DIV READOUT

Horizontal scale factor (combination of horizontal range and magnification settings) readout, directly at front panel, indicates either distance or time/div.

DISTANCE OR TIME POSITION

Ten-turn dial directly reads one-way distance or round-trip time to test-line discontinuity. Round-trip time readings are accurate to within $\pm 1\%$. Range of 10-turn dial is the same as the full-scale, 10-div display without magnification.

JITTER

Less than or equal to 20 ps with internal pulse sources.

DIELECTRIC

Calibrated for air, tfe and polyethylene lines. Preset mode adjustable for lines with velocity of propagation from 0.6 to 1.0X velocity of light.

DISPLAY MODES

Repetitive or single sweep, manual or external scan.

HORIZONTAL OUTPUT

1 V for each division of displayed signal through 10 k Ω .

PULSE SOURCES

FAST-RISE OUTPUT

Approximately 50-ps risetime, 250 mV. 50- Ω source (reverse terminated).

LARGE-AMPLITUDE OUTPUT

Approximately 1-ns risetime, 1 V. 50- Ω source (reverse terminated).

PERFORMANCE AS SAMPLER

RISETIME

Less than or equal to 90 ps.

BANDWIDTH

Equivalent to DC-to-3.9 GHz at 3-dB down.

TYPE 1S2

DEFLECTION FACTOR

5 mV/div to 500 mV/div in 7 calibrated steps, 1-2-5 sequence, accurate within 3%. Continuous variation between steps, uncalibrated.

RANDOM NOISE

Equivalent to an input signal of 2 mV or less (tangentially-measured).

SIGNAL RANGE

Signals between +2 V and -2 V limits may be displayed at any deflection-factor setting. Safe overload is ± 3 V if signal channel is coupled directly into EXT TRIG INPUT, ± 5 V if not.

TRIGGERING

SOURCE: External only, AC coupled—may serve as termination for signal channel. AMPLITUDE: Sinewaves, 100 mV to 2 V, peak-to-peak; Pulses, 50 mV to 1 V either polarity. 3 V max DC. REPETITION RATE: Sinewave triggering or synchronizing from 100 kHz through 5 GHz. Pulse triggering from 10 Hz through 5 GHz. JITTER: Depends on signal shape, repetition rate and amplitude; ≤ 30 ps under optimum conditions.

WEIGHTS

Net weight	7½ lb	3.3 kg
Domestic shipping weight	≈18 lb	≈ 8.2 kg
Export-packed weight	≈28 lb	≈12.7 kg

INCLUDED STANDARD ACCESSORIES

Two GR elbows (017-0070-00); 5X attenuator (017-0079-00); 2X attenuator (017-0080-00); 50- Ω termination (017-0081-00); 20-cm air line (017-0084-00); 50- Ω termination, short circuit (017-0087-00); 5-ns cable, RG 8/213 (017-0502-00); 18-inch patch cord (012-0039-00); 18-inch BNC-to-banana plug patch cord (012-0090-00); two instruction manuals (070-0543-00).

OPTIONAL ACCESSORIES

Type 113 Delay Cable

Type P6034 10X Probe Package, order 010-0110-00

Type P6035 100X Probe Package, order 010-0111-00

Power Divider, GR 874-TPD, order 017-0082-00

Coupling Capacitor, GR 874-K, order 017-0028-00

This listing covers only a few of the more commonly useful items for sampling instruments. A more complete listing can be found in the accessory section of this catalog.

Please refer to Terms and Shipment, General Information page.

DC-to-15 MHz OSCILLOSCOPE



- **ACCEPTS MULTI-TRACE, DIFFERENTIAL, SAMPLING AND SPECTRUM ANALYZER PLUG-IN UNITS**
- **8 x 10-CM DISPLAY**
- **ILLUMINATED PARALLAX-FREE GRATICULE**
- **X-Y DISPLAYS**

The Tektronix Type 561A and Type RM561A Oscilloscopes have a complete selection of plug-ins, permitting changing measurement capabilities to meet changing measurement needs. Amplifier plug-ins offer a wide range of measurement capabilities with 10-MHz dual-trace plug-ins, 10 μ V/div differential plug-ins, 50-ps sampling plug-ins and spectrum analyzer plug-ins covering the spectrum from 50 Hz to 36 MHz. Time-base plug-ins include delayed sweep, X50 magnifier, single time-bases or sampling time-bases. Two amplifier plug-ins may be used for X-Y or multiple X-Y displays. An automatic seeking amplifier and time base are also available.

Both the Type 561A and the Type RM561A use a 8 by 10-cm cathode-ray tube that features an internal graticule with controllable illumination. Thus, you can take photographs with the same ease, but without the parallax of the external graticule.

Occupying only 7 inches of rack height, the Type RM561A bolts directly to the rack but may be ordered with optional slide-out tracks at additional cost.

CHARACTERISTIC SUMMARY

VERTICAL

Vertical deflection characteristics are extremely flexible through use of 2-Series and 3-Series Amplifier Plug-In Units.

HORIZONTAL

Horizontal deflection characteristics are extremely flexible through use of 2-Series and 3-Series Amplifier and Time-Base Units.

CRT

DISPLAY AREA—8 x 10 cm.

ACCELERATING VOLTAGE—3.5 kV.

PHOSPHOR—P31

OTHER

AMPLITUDE CALIBRATOR—0.2 mV to 100 V (561A), 1 mV to 100 V (RM561A), and 0.1 V into 50 Ω , power line-frequency.

POWER REQUIREMENTS—105 to 125 V or 210 to 250 V, 50 to 400 Hz (561A), 50 to 60 Hz (RM561A), 240 watts maximum.

TYPE **561A** **RM561A**

PARALLAX-FREE MEASUREMENTS—CONVENIENT PHOTOGRAPHY

The internal graticule eliminates parallax, a common cause of erroneous readings. Parallax is an apparent displacement of the trace in relationship to the graticule. It occurs when the trace is on a different plane than the graticule, and is not viewed from exactly the same angle for all parts of the display.

When the trace and graticule are on the same plane, as on the cathode-ray tube of the Type 561A and RM561A Oscilloscope, parallax is eliminated.

Controllable illumination of the internal graticule enables you to easily take waveform photographs in which the graticule rulings are sharply delineated. This was formerly possible only with oscilloscopes using external graticules.

Adding to the convenience of operation the Type RM561A has numbered settings of the illumination control that serve as an approximate exposure guide.

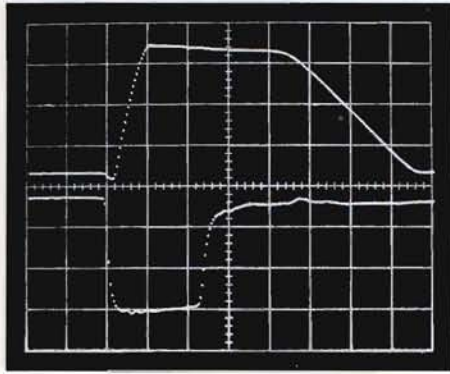

SAMPLING
Transistor turn-on and turn-off (upper trace). Driving pulse (lower trace).

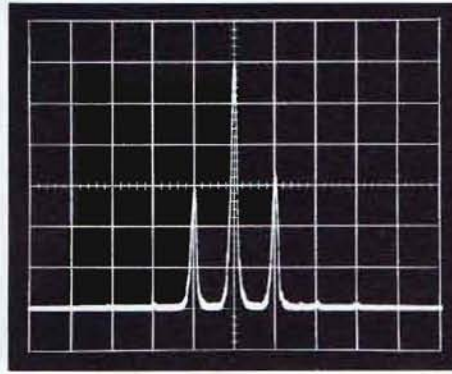

SPECTRUM ANALYZER
Waveform showing center frequency and two sidebands.

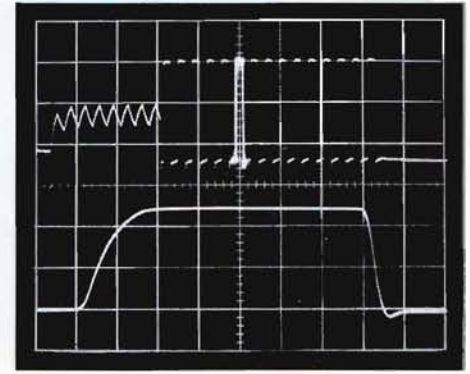

DELAYING SWEEP (Double exposure)
Intensified portion of waveform (upper trace) expanded (lower trace) by means of delayed sweep.

PLUG-IN UNITS

PLUG-IN UNIT	MINIMUM DEFLECTION FACTOR	BANDWIDTH (-3 dB)	T _R	PLUG-IN UNIT	MINIMUM DEFLECTION FACTOR	BANDWIDTH (-3 dB)	T _R
MULTIPLE TRACE				SPECIAL PURPOSE			
3A1 Dual-Trace	10 mV/div	DC to 10 MHz	35 ns	3A8 Operational	20 mV/div	DC to 3.5 MHz	100 ns
3A3 Dual-Trace	100 μV/div	DC to 500 kHz	0.7 μs	3C66 Carrier Amp.	10 μstrain/div	DC to 5 kHz	70 μs
3A6 Dual-Trace	10 mV/div	DC to 10 MHz	35 ns	SINGLE TRACE			
3A72 Dual-Trace	10 mV/div	DC to 650 kHz	0.54 μs	2A60	50 mV/div	DC to 1 MHz	0.35 μs
3A74 Four-Trace	20 mV/div	DC to 2 MHz	0.18 μs	3A5 Automatic/Prog.	10 mV/div 1 mV/div	DC to 15 MHz DC to 5 MHz	23 ns
DIFFERENTIAL				3A75	50 mV/div	DC to 4 MHz	90 ns
2A61 High-Gain	10 μV/div	0.06 Hz to 300 kHz	1.2 μs	TIME-BASE UNITS			
2A63	1 mV/div	DC to 300 kHz	1.2 μs	TYPE	FASTEST TIME-BASE RATE	MAGNIFIER	FEATURES
3A3	100 μV/div	DC to 500 kHz	0.7 μs	2B67	1 μs/div	X5	single sweep
3A7 Comparator	1 mV/div	DC to 10 MHz	35 ns	3B3	0.5 μs/div	X5	calib sweep delay; single sweep
SPECTRUM ANALYZERS				3B4	0.2 μs/div	X1 to X50	single sweep
3L5	10 μV/div	10 Hz to 1 MHz		3B5 Automatic/Programmable	0.1 μs/div	X10 X100	calib delay mag; auto-peek pro-grammable
3L10	-100 dBm	1 MHz to 36 MHz Center Freq.		SAMPLING			
3S1 Dual-Trace	2 mV/div	DC to 1 GHz	350 ps	3T2	20 ps/div	X10	random sampling
3S2 Dual-Trace	2 mV/div			3T4 Programmable Sampling	1 ns/div	X10	single sweep; manual scan; calib sweep delay
S1		DC to 1 GHz	350 ps	3T77A Sampling	0.2 ns/div	X10	single sweep; manual scan sweep delay
S2		DC to 7 GHz	50 ps				
3S3 Dual-Trace	5 mV/div	DC to 1 GHz	350 ps				

CONVENTIONAL DISPLAYS

A wide range of non-sampling bandwidths and deflection factors are available in the selection of 2-Series and 3-Series Amplifier Plug-In Units. These include both single-trace and multi-trace units. The Types 2A61, 2A63, 3A3, and 3A7 are differential amplifier units while the Type 3C66 is useful for strain-gage and similar transducer operations.

Normal sweep, single sweep, magnified or delayed sweep is available with the group of 2-Series and 3-Series time-base plug-in units.

AUTOMATIC SEEKING

The Types 3A5 Amplifier (DC to 15 MHz) and 3B5 Time-Base are automatic-seeking plug-in units. These units, when commanded, have the ability to sense voltage levels and time changes and adjust their deflection factors to present calibrated on-screen displays. The control settings are read out on the front panels in large, lighted digits.

SAMPLING DISPLAYS

The Type 3T77A, 3T2 and 3T4 Sampling Sweep Units with the Type 3S1, Type 3S2 and Type 3S3 Amplifier Units give a dual-trace sampling system with risetimes in the subnano-second region.

SPECTRUM ANALYSIS

The Type 3L10 Spectrum Analyzer Plug-In Unit covers the 1-36 MHz range. This plug-in unit with a sensitivity of -100 dBm and calibrated dispersion allows the display of RF signals with a resolution of 10 Hz to 1 kHz.

The Type 3L5 Spectrum Analyzer Plug-In Unit provides both spectral and time-based displays from 10 Hz to 1 MHz. Calibrated dispersion is 10 Hz/div to 100 kHz/div. Sensitivity is $10 \mu\text{V}/\text{div}$ RMS for spectral displays, 1 mV/div peak to peak for time-based displays

X-Y DISPLAYS

The Types 2A60, 2A61, 2A63, 3A3, 3A72, 3A74, and 3A75 Amplifier Plug-In Units operate equally well in the vertical and horizontal compartments of the Type 561A and RM561A permitting X-Y displays using any combination of these plug-in units. Plug-in units other than these listed above are not recommended for X-Y displays.

For medium and high-frequency X-Y operation, use of two units of the same type is recommended. Deflection-circuit capacitances of the Type 561A and RM561A are carefully standardized to minimize high frequency phase-shift between two plug-ins of the same type when operated X-Y.

MULTIPLE X-Y DISPLAYS

Using two Type 3A72 or two Type 3A74 Plug-In Units, both synchronization and automatic pairing are provided. With two 3A72's operated X-Y in the dual-trace mode, Channel 1 of the left-hand plug-in is always plotted against Channel 1 of the right-hand plug-in. With two Type 3A74's, two, three, or four independent displays may be obtained, properly paired: Channel 4 versus Channel 4, Channel 3 versus Channel 3, etc. . . .

Using two Type 3A1 or two Type 3A6 Plug-In Units, dual-trace switching is not synchronized. Dual X-Y displays within the center 8 cm x 8 cm area of the graticule may be obtained, but one plug-in or the other must usually be limited to single-trace operation unless four displays are wanted.

Using two Type 3A3 Plug-In Units, dual-trace switching is synchronized, so one Y Channel remains plotted against the same X Channel once the display is set up. There is no provision for consistent pairing each time the system is operated.

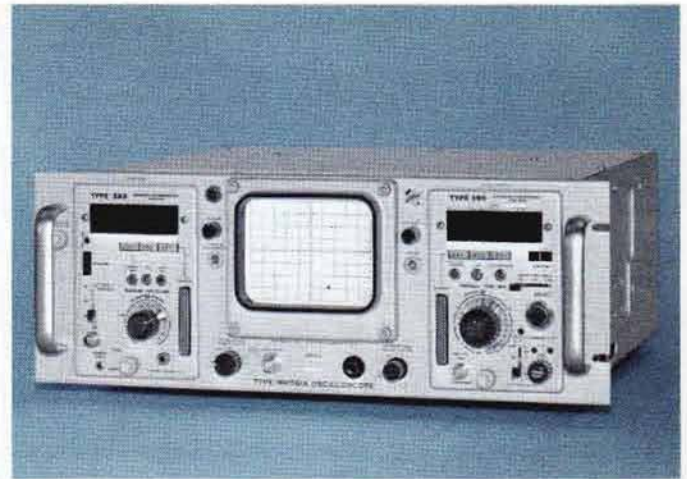

As with single X-Y displays, two plug-ins of the same type should always be used where X-Y phase relationships are to be preserved.

RASTER GENERATION

A raster display can be presented by using two time-base plug-in units, one in each compartment. Signal modulation can be achieved through the Z-axis of the CRT.

TYPE 561A CHARACTERISTICS

PLUG-IN COMPARTMENTS

Accepts all 2-Series and 3-Series Amplifier and Time-Base Units.

TEKTRONIX CRT

Flat-faced rectangular 5-in tube with internal "no parallax" graticule, controllable edge-lighting, 3.5-kV monoaccelerator, beam-deflection unblanking. A P31 Phosphor is normally supplied.

ILLUMINATED INTERNAL GRATICULE

Edge lighted graticule marked in 8 vertical and 10 horizontal cm divisions. The centerlines are marked every 2 mm. Illumination is controlled by a front-panel knob.

DISPLAY CONTROLS

Front-panel controls include Focus, Intensity, and Scale Illumination (of the 8-cm by 10-cm display area), in addition to screwdriver adjustments for Astigmatism and Trace Alignment.

Z-AXIS INPUT

Accessible through a terminal at the rear of the instrument permits external modulation of the CRT cathode.

AMPLITUDE CALIBRATOR

18 squarewave voltages from 0.2 mV to 100 V, peak to peak, accurate within 3%; approximately 5- μs risetime, at line frequency. For 50 Ω systems the 0.5 V position provides 0.1 V into 50 ohms for convenient amplitude calibration of sampling units.

ELECTRONICALLY-REGULATED SUPPLIES

All voltages required for proper operation of the indicator and the plug-in units are regulated. DC-supply provides 85 watts for powering the 2-Series and 3-Series Plug-In Units. Supplies operate normally with or without plug-ins.

POWER REQUIREMENTS

240 watts maximum, 50 to 400 Hz. Instrument factory wired for 105 V to 125 V (117 V nominal) operation. Transformer taps permit operation at 210 V to 250 V (234 V nominal). Instrument can be ordered factory wired for 210 V to 250 V operation.

TYPE **561A** **RM561A**

DIMENSIONS AND WEIGHTS

Height	14½ in	36.8 cm
Width	10 in	25.4 cm
Depth	21⅛ in	53.7 cm
Net weight	32 lb	14.6 kg
Domestic shipping weight	≈40 lb	≈18.2 kg
Export-packed weight	≈50 lb	≈22.7 kg

INCLUDED STANDARD ACCESSORIES

3 to 2-wire adapter (103-0013-00); 3-conductor power cord (161-0010-03); CRT protector plate (387-0935-00); smoke gray filter (installed) (378-0560-00); 18-inch red patch cord, BNC-to-BNC (012-0087-00); 18-inch red patch cord, BNC-to-banana plug (012-0091-00); red post jack, BNC (012-0092-00); two instruction manuals (070-0342-00).

TYPE RM561A RACKMOUNT

Electrically identical to the Type 561A except the calibrator range is 1 mV to 100 V and the line-frequency range is 50 to 60 Hz. Instrument mounts to a standard 19-inch rack. (Additional mounting information on Catalog Instrument Dimensions page).

DIMENSIONS AND WEIGHTS

Height	7 in	17.8 cm
Width	19 in	48.3 cm
Rack depth	18⅞ in	46.7 cm
Net weight	32¼ lb	14.7 kg
Domestic shipping weight	≈55 lb	≈25.0 kg
Export-packed weight	≈74 lb	≈33.6 kg

INCLUDED STANDARD ACCESSORIES

Same as Type 561A, but includes mounting hardware; power cord (161-0024-00); and two instruction manuals (070-0352-01).

TYPE RM561A WITH SLIDE-OUT TRACKS

Type RM561A MOD 171A mounts to a standard 19-inch rack on slide-out tracks. It can be pulled out, tilted, and locked in any one of seven positions for convenient servicing. Instrument has same standard accessories as the Type RM561A, but also includes one pair of mounting tracks (351-0084-00).

OPTIONAL ACCESSORIES

Optional accessories increase measurement capability and provide added convenience. The probes recommended for use with these instruments are covered on the 2- and 3-series plug-in unit pages. Additional probes are available that may be better suited for a particular application, including current and high-voltage measurements. See the catalog accessory pages for information on these and other items.

CAMERAS

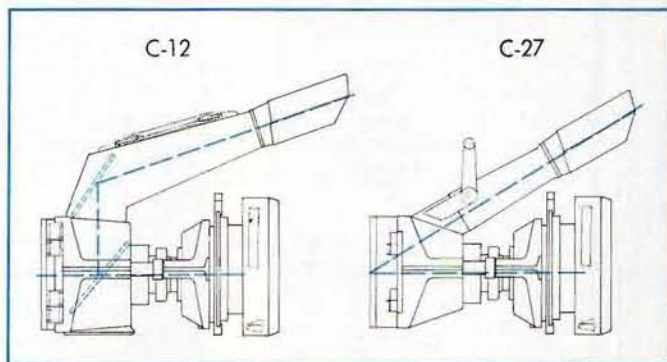

Standard C-12 with beam-splitting mirror for straight-on viewing and use of optional projected graticule; f/1.9—1:0.85 lens, Polaroid Land* Pack Film back

Type 561A or RM561A to C-12 Camera adapter, order 016-0217-00

Standard C-27 has rotating and removable viewing hood allowing mounting on adjacent Type RM561A's, f/1.9—1:0.85 lens. Polaroid Land* Pack Film back

Type 561A or RM561A to C-27 Camera adapter, order 016-0224-00

SCOPE-MOBILE® CART

Model 201-2 for Type 561A: two plug-in carrier, 9-position tilt-lock oscilloscope tray

SLIDE-OUT TRACKS

Converts standard Type RM561A for easy withdrawal and tilt of instrument, order 351-0050-00

CRADLE ASSEMBLY

Provides rear slide support when RM561A with slide-out tracks is mounted in a backless rack, order 040-0344-00

*Registered Trade-Mark Polaroid Corporation

Please refer to Terms and Shipment, General Information page.

SPLIT-SCREEN STORAGE OSCILLOSCOPES



- **BISTABLE SPLIT-SCREEN STORAGE**
- **UP TO 500 cm/ms WRITING SPEED**
- **ACCEPTS MULTI-TRACE, DIFFERENTIAL, SAMPLING AND SPECTRUM ANALYZER PLUG-IN UNITS**
- **X-Y DISPLAYS**

The Types 564 and RM564 Storage Oscilloscopes are virtually two instruments in one, offering all the advantages of a split-screen storage oscilloscope, plus those of a conventional plug-in oscilloscope. A complete selection of plug-ins permits changing the oscilloscope's performance to meet changing measurement needs.

With the split-screen storage feature, either half of the 8 x 10-cm display can be independently controlled, thus allowing stored or conventional displays on either the upper or lower half. The contrast ratio and brightness of the stored displays are constant and independent of viewing time, writing and sweep rates, or signal repetition rates.

The Type 564 and RM564 have dual plug-in flexibility with vertical and horizontal plug-in units. Amplifier plug-ins offer a wide range of measurement capabilities with 10-MHz multi-trace, 10- μ V differential, 50-ps sampling and spectrum analyzer plug-ins. Time-base plug-ins include delayed sweep, X50 magnifier, single time-bases and sampling time-bases. Amplifier plug-ins may be placed in the horizontal position for X-Y or multiple X-Y displays and automatic seeking plug-ins are available.

CHARACTERISTIC SUMMARY

VERTICAL

Vertical deflection characteristics are extremely flexible through use of 2-Series and 3-Series Amplifier Plug-In Units (see chart).

HORIZONTAL

Horizontal deflection characteristics are extremely flexible through use of versatile 2-Series and 3-Series Amplifier and Time-Base Units (see chart).

STORAGE CRT

DISPLAY AREA—8 x 10 cm.

ACCELERATING VOLTAGE—3.5 kV.

SPLIT SCREEN STORAGE—Store on either upper or lower half of screen with non-storage on other half; store on entire screen; or non-store on entire screen.

VIEWING TIME—Up to one hour.

ERASE TIME—Approximately 0.25 second.

WRITING SPEED—Up to 500 cm/ms.

PHOSPHOR—P1

OTHER

AMPLITUDE CALIBRATOR—0.2 mV to 100 V (564), 1 mV to 100 V (RM564), and 0.1 V into 50 Ω , power line-frequency.

POWER REQUIREMENTS—105 to 125 V or 210 to 250 V.

TYPE **564** **RM564**

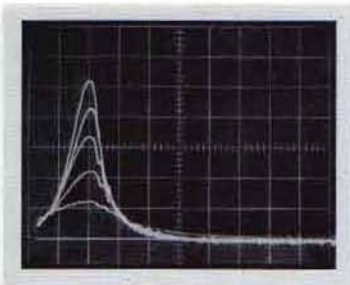

SHOCK TEST

Display shows ability of the Type 564 to store consecutive events for comparison or photography. Waveforms indicate shock imparted by dropping sub-table weight of 5 lbs from different heights.

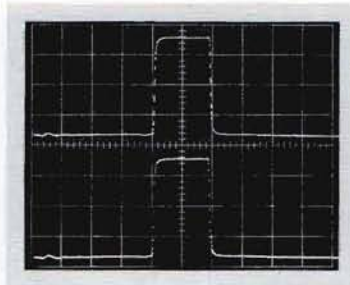

LOW-REPETITION RATE SAMPLING

Display shows ability of the Type 564 (with sampling plug-in units) to record complete sampling waveforms at low repetition rates. Upper trace is stored. Lower trace is not stored. This capability for storing low-repetition-rate waveforms allows observation and analysis of the entire sampled display at one time.

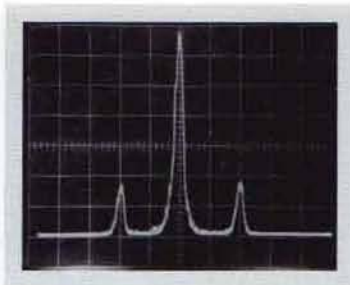

STORED SPECTRAL DISPLAY

Stored waveform showing center frequency with two sidebands. Using single-sweep and storage allows measurement of frequency drift with spectrum analyzer unit.

PLUG-IN UNITS

PLUG-IN UNIT	MINIMUM DEFLECTION FACTOR	BANDWIDTH (-3 dB)	T _R		PLUG-IN UNIT	MINIMUM DEFLECTION FACTOR	BANDWIDTH (-3 dB)	T _R	
MULTIPLE TRACE					SPECIAL PURPOSE				
3A1 Dual-Trace	10 mV/div	DC to 10 MHz	35 ns		3A8 Operational	20 mV/div	DC to 3.5 MHz	100 ns	
3A3 Dual-Trace	100 μV/div	DC to 500 kHz	0.7 μs		3C66 Carrier Amp.	10 μstrain/div	DC to 5 kHz	70 μs	
3A6 Dual-Trace	10 mV/div	DC to 10 MHz	35 ns		SINGLE TRACE				
3A72 Dual-Trace	10 mV/div	DC to 650 kHz	0.54 μs		2A60	50 mV/div	DC to 1 MHz	0.35 μs	
3A74 Four-Trace	20 mV/div	DC to 2 MHz	0.18 μs		3A5 Automatic/Prog.	10 mV/div 1 mV/div	DC to 15 MHz DC to 5 MHz	23 ns	
DIFFERENTIAL					3A75	50 mV/div	DC to 4 MHz	90 ns	
2A61 High-Gain	10 μV/div	0.06 Hz to 300 kHz	1.2 μs		TIME-BASE UNITS				
2A63	1 mV/div	DC to 300 kHz	1.2 μs			FASTEST TIME-BASE RATE	MAGNIFIER	FEATURES	
3A3	100 μV/div	DC to 500 kHz	0.7 μs		2B67	1 μs/div	X5	single sweep	
3A7 Comparator	1 mV/div	DC to 10 MHz	35 ns		3B1	0.5 μs/div	X5	sweep delay	
SPECTRUM ANALYZERS					3B3	0.5 μs/div	X5	calib sweep delay; single sweep	
3L5	10 μV/div	10 Hz to 1 MHz			3B4	0.2 μs/div	X1 to X50	single sweep	
3L10	-100 dBm	1 MHz to 36 MHz Center Freq.			3B5 Automatic/Programmable	0.1 μs/div	X10 X100	calib delay mag; auto-peek programmable	
SAMPLING									
3S1 Dual-Trace	2 mV/div	DC to 1 GHz	350 ps		3T2	20 ps/div	X10	random sampling	
3S2 Dual-Trace	2 mV/div				3T4 Programmable Sampling	1 ns/div	X10	single sweep; manual scan; calib. sweep delay	
S1		DC to 1 GHz	350 ps		3T77A Sampling	0.2 ns/div	X10	single sweep; manual scan sweep delay	
S2		DC to 7 GHz	50 ps						
3S3 Dual-Trace	5 mV/div	DC to 1 GHz	350 ps						

STORAGE OPERATION

Features of the Type 564 as a storage oscilloscope include—
 Long-term storage with short-time erasure.
 Storage of single shot signals.
 Split-screen with individual controls for each half.

SOME THINGS YOU CAN DO WITH TYPE 564 STORED DISPLAYS

1. Observe single-shot phenomena.
2. Study, for long periods of time, a waveform without having to photograph it. (Stored brightness and contrast remain essentially constant for up to an hour.)
3. Photograph only those stored waveforms you want.
4. Compare changing waveforms to a stored waveform, each displayed on half of the CRT face.
5. Change the stored standard while viewing other waveforms on the non-stored half.
6. Photograph a multi-event stored display with only one exposure.
7. Store fast recurrent phenomena by using the integrate feature.
8. Store X-Y displays.

AVAILABLE DISPLAYS

With the wide-range sensitivity and bandwidth of the Type 564, several storage and conventional operation displays are obtainable. The range of signals which may be stored is limited by stored-mode writing characteristics of the CRT.

SINGLE-TRACE AND MULTI-TRACE

These displays are obtained by selecting either sampling or non-sampling amplifier plug-in units. Selection of the Type 2A61, 2A63, or 3A3, gives differential amplifier operation, while strain gage and other transducer operations are available with the Type 3C66.

SAMPLING

Risetimes in the sub-nanosecond region are obtained by using Type 3T77A, 3T2, or 3T4 Sampling Sweep Unit with either a Type 3S1, Type 3S2 or Type 3S3 Amplifier Unit. These combinations will provide a dual-trace display or a single display.

SPECTRUM ANALYSIS

The Type 3L10 Spectrum Analyzer Plug-In Unit covers the 1—36 MHz range. This plug-in unit, with a sensitivity of -100 dBm and calibrated dispersion, allows the display of RF signals with a resolution of 10 Hz to 1 kHz.

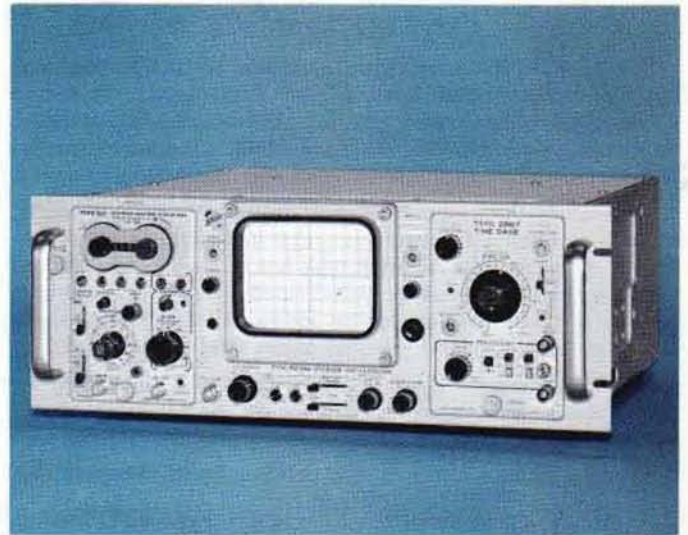

The Type 3L5 Spectrum Analyzer Plug-In Unit provides both spectral and time-based displays from 10 Hz to 1 MHz. Calibrated dispersion is 10 Hz/div to 100 kHz/div. Sensitivity is 10 μ V/div RMS for spectral displays, 1 mV/div peak to peak for time-based displays.

SINGLE X-Y

X-Y display can be obtained by using any combination of the Type 2A60, 2A63, 3A3, 3A72, 3A74, and 3A75 Units in both the vertical and horizontal compartments of the Type 564.

For medium and high-frequency X-Y operation, however, use two units of the same type. Careful standardization of deflection-circuit capacitance in the Type 564, minimizes high frequency phase-shift between two of the same type plug-in units when operated X-Y.

MULTIPLE X-Y

Using two Type 3A72 or two Type 3A74 Plug-In Units, both synchronization and automatic pairings are provided. With two 3A72's operated X-Y in the dual trace mode, Channel 1 of the left-hand plug-in is always plotted against Channel 1 of the right-hand plug-in. With two Type 3A74's, two, three, or four independent displays may be obtained, properly paired: Channel 4 versus Channel 4, Channel 3 versus Channel 3, etc. . . .

Using two Type 3A1 or two Type 3A6 Plug-In Units, dual-trace switching is not synchronized. Dual X-Y displays within the center 8 cm x 8 cm area of the graticule may be obtained, but one plug-in or the other must usually be limited to single-trace operation unless four displays are wanted.

Using two Type 3A3 Plug-In Units, dual-trace switching is synchronized, so one Y Channel remains plotted against the same X Channel once the display is set up. There is no provision for consistent pairing each time the system is operated.

As with single X-Y displays, two plug-ins of the same type should always be used where X-Y phase relationships are to be preserved.

TYPE **564** **RM564**

CRT PERFORMANCE

There are two storage tubes available for use in the Type 564 Oscilloscope. Both tubes exhibit characteristics of a conventional CRT when used in the non-stored mode. The standard tube, the Type T5640-200, has the brighter stored display. The other tube, the Type T5640-201, has the faster writing speed.

By selecting the proper tube, you can obtain optimum oscilloscope performance for your particular application. Such selection is important because each tube has its own maximum writing speed and brightness for stored-mode operation. The brightness of a stored display for an individual tube is one value regardless of the intensity of the beam that generated it.

The hours shown are the actual hours the CRT is used in the stored mode with repetitive writing, storing, and erasing. It should be noted that non-storage operation of the CRT has little effect on the age characteristics shown. Therefore to obtain maximum CRT performance and service, the oscilloscope should be in the non-stored mode when stored displays are not needed.

TYPICAL LIFE CHARACTERISTICS

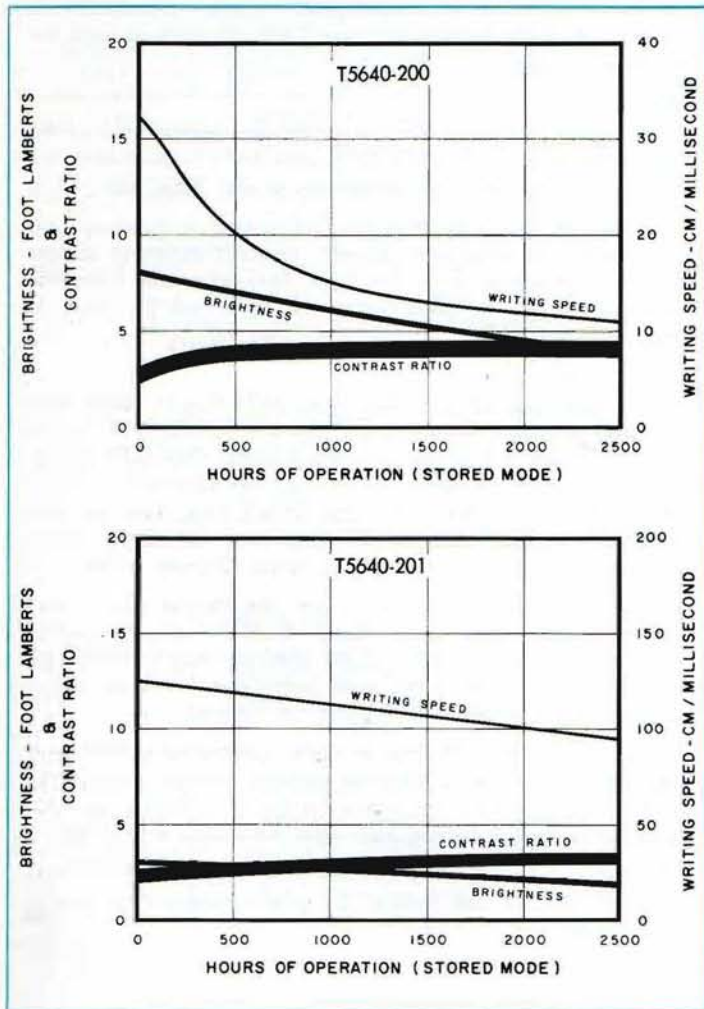

TEKTRONIX STORAGE CRT

The CRT is a Tektronix Type T5640, flat-faced bistable storage tube with beam-deflection blanking and an accelerating voltage of 3.5 kV. It has an 8 x 10 cm storage target divided into two 4 x 10 cm areas, individually controllable for storage and erasure.

WARRANTED MINIMUM CHARACTERISTICS

Characteristics	T5640-200*	T5640-201†
Minimum Initial Brightness	6 foot-lamberts	2 foot-lamberts
Typical Brightness at 1000 hours (% of initial)	70%	80%
Writing Speed, Initial Minimum	25 cm/ms††	100 cm/ms††
Writing Speed at 1000 hours, (% of initial)	25%	90%

*Supplied with Type 564

†Supplied with Type 564 MOD 08

††Specification holds true for middle 7 x 9 cm area.

STORAGE CHARACTERISTICS

VIEWING TIME

Displays can be stored for viewing up to 1 hour. Longer times may be obtained but tend to reduce target sensitivity in the stored areas.

ERASURE TIME

Approximately 0.25 second.

STORED WRITING-SPEED ENHANCEMENT

This feature controls the single-sweep storage capabilities of the storage CRT. Through adjustment of the front-panel Writing-Rate Increase control, single-trace spot velocities up to 250 cm/ms using the T5640-200 CRT or up to 500 cm/ms using the T5640-201 CRT can be stored with minimal loss of resolution and contrast in the center 7 x 9 cm.

SINGLE SHOT SIGNALS

At slow or medium speeds, single-shot signals are easily stored for extended viewing time (within writing-speed capabilities of CRT selected).

INTEGRATE MODE

Increases the effective writing speed for repetitive fast signals with repetition rates that are too low for effective storage, but which may be too fast for satisfactory single-shot storage with enhancement.

TYPE 564 CHARACTERISTICS

PLUG-IN COMPARTMENTS

The instrument accepts 2-Series and 3-Series Amplifier and Time-Base Units.

LOCATE BUTTON

This button, when depressed, causes a spot or spots to appear at the left of the CRT screen at the vertical position of the next sweep.

EXTERNAL GRATICULE

The graticule is edge lighted and is marked in 8 vertical and 10 horizontal cm divisions. The centerline is marked every 2 mm. Illumination is controlled by a front-panel knob.

Z-AXIS INPUT

Accessible through a terminal at the rear of the instrument permits external modulation of the CRT cathode.

AMPLITUDE CALIBRATOR

18 squarewave voltages from 0.2 mV to 100 V peak to peak, accurate within 3%; approximately 5- μ s risetime, at line frequency. For 50- Ω systems, the 0.5-V switch position provides 0.1 V (peak to peak) into 50 ohms, for convenient calibration of sampling units.

ELECTRONICALLY REGULATED SUPPLIES

Regulated power supplies furnish all voltages required for proper operation of the Indicator and the plug-in units.

POWER REQUIREMENTS

240 watts maximum, 50 to 400 Hz. Instrument factory wired for 105 V to 125 V (117 V nominal) operation. Transformer taps permit operation at 210 V to 250 V (234 V nominal). Instrument can be ordered factory wired for 210 V to 250 V operation.

DIMENSIONS AND WEIGHTS

Height	14 ¹¹ / ₁₆ in	37.3 cm
Width	9 ³ / ₄ in	24.8 cm
Depth	21 ¹ / ₈ in	53.7 cm
Net weight	33 ¹ / ₄ lb	15.2 kg
Domestic shipping weight	≈43 lb	≈19.5 kg
Export-packed weight	≈54 lb	≈24.6 kg

INCLUDED STANDARD ACCESSORIES

Polarized viewer (016-0039-00); 3 to 2-wire adapter (103-0013-00); 3-conductor power cord (161-0010-03); patch cord, BNC-to-BNC, 18 inch (012-0087-00); patch cord, BNC-to-banana plug, 18 inch (012-0091-00); post jack, BNC (012-0092-00); two instruction manuals, (070-0351-00).

TYPE RM564 RACKMOUNT

Similar to the Type 564 except the calibrator range is 1 mV to 100 V and the line-frequency range is 50 to 60 Hz. In addition, the RM564 has a connector on the rear panel for remote erase of the stored waveform on either or both halves of the split-screen storage tube. Instrument mounts to a standard 19-inch rack. (Additional mounting information on Catalog Instrument Dimensions page).

DIMENSIONS AND WEIGHTS

Height	7 in	17.8 cm
Width	19 in	48.3 cm
Rack depth	18 ⁷ / ₁₆ in	46.9 cm
Net weight	33 ³ / ₄ lb	15.3 kg
Domestic shipping weight	≈57 lb	≈26.0 kg
Export-packed weight	≈79 lb	≈35.9 kg

INCLUDED STANDARD ACCESSORIES

Same as Type 564, but includes mounting hardware; power cord (161-0024-00); and two instruction manuals (070-0415-00).

TYPE RM564 WITH SLIDE-OUT TRACKS

Type RM564 MOD 171A or Type RM564 MOD 08, MOD 171A mounts to a standard 19-inch rack on slide-out tracks. It can be pulled out, tilted, and locked in any one of seven positions for convenient servicing. Instrument has same standard accessories as the Type RM564, but also includes one pair of mounting tracks (351-0084-00).

OPTIONAL ACCESSORIES

Optional accessories increase measurement capability and provide added convenience. The probes recommended for use with these instruments are covered on the 2- and 3-series plug-in unit pages. Additional probes are available that may be better suited for a particular application, including current and high-voltage measurements. See the catalog accessory pages for information on these and other items.

CAMERAS

Standard C-12 with beam-splitting mirror for straight-on viewing and use of optional projected graticule; f/1.9—1:0.85 lens, Polaroid Land* Pack Film back

Type 564 or RM564 to C-12 Camera adapter, order 016-0217-00

Standard C-27 has rotating and removable viewing hood allowing mounting on adjacent Type RM564's f/1.9—1:0.85 lens, Polaroid Land* Pack Film back

Type 564 or RM564 to C-27 Camera adapter, order 016-0224-00

SCOPE-MOBILE® CART

Model 201-2 for Type 564: two plug-in carrier, 9-position tilt-lock oscilloscope tray

SLIDE-OUT TRACKS

Converts standard Type RM564 or RM564 MOD 08 for easy withdrawal and tilt of instrument, order 351-0050-00

CRADLE ASSEMBLY

Provides rear slide support when RM564 with slide-out tracks is mounted in a backless rack, order 040-0344-00

REMOTE-ERASE CONNECTOR

Mates with 9-pin connector on the rear panel of RM564, supplied without cable, order 134-0049-00

REPLACEMENT CATHODE-RAY TUBES

For optimum stored brightness, order 154-0410-00

For optimum writing speed, order 154-0418-00

*Registered Trade-Mark Polaroid Corporation

Please refer to Terms and Shipment, General Information page.

DUAL-BEAM OSCILLOSCOPES

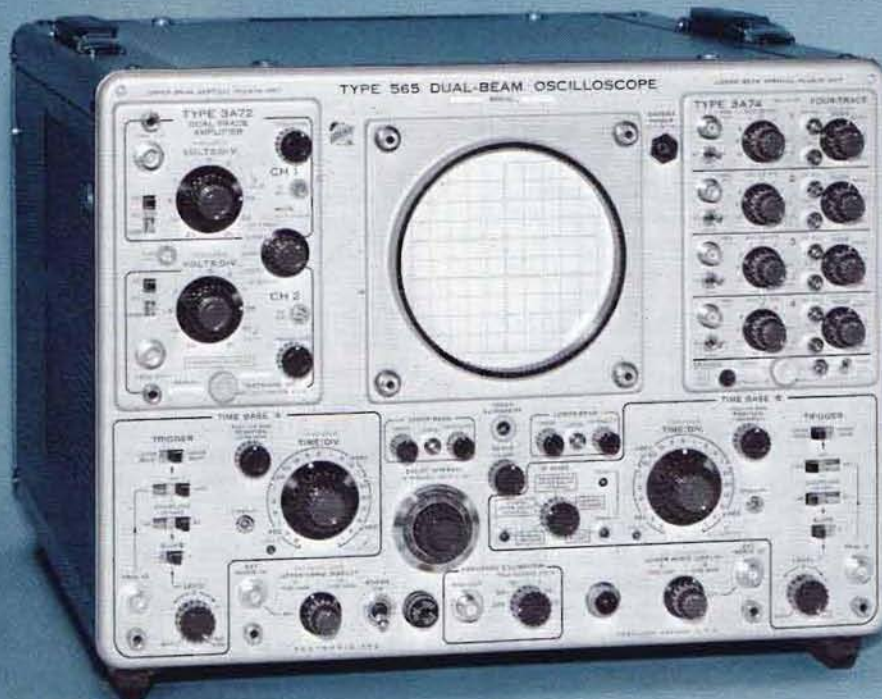

- **TWO VERTICAL AND HORIZONTAL SYSTEMS**
- **8 x 10-CM DISPLAY PER BEAM**
- **ILLUMINATED NO-PARALLAX GRATICULE**
- **CALIBRATED SWEEP DELAY**
- **REAR-PANEL OUTPUT CONNECTORS**
- **ACCEPTS WIDE VARIETY OF VERTICAL PLUG-INS**

A Type 565, or rack-mount counterpart Type RM565, is essentially two single-beam oscilloscopes sharing a common cathode-ray tube and power supply. Each beam has separate vertical and horizontal deflection systems, focus, and intensity controls.

The vertical amplifiers can be any of 2-Series or 3-Series Plug-In Units, except Spectrum Analyzer and Sampling Units. The horizontal amplifiers are built-in and can be driven by either of two sweep systems, simultaneously or independently, or from their external inputs. Front-panel controls permit using "A" sweep as a delaying sweep and "B" as the delayed sweep. In this mode of operation the upper beam is intensified for the duration of the "B" sweep. "B" sweep may also be used for single-sweep operation.

There are rear-panel outputs of: Vertical Signals, Horizontal Signals, + Gate, Delayed Trigger, and Auxiliary Power.

CHARACTERISTIC SUMMARY

VERTICAL

2 identical vertical-deflection systems

Vertical deflection characteristics are extremely flexible through use of 2-Series and 3-Series Plug-In Units.

HORIZONTAL

2 independent horizontal-deflection systems

CALIBRATED TIME BASE—1 μ s/div to 5 s/div.

10X MAGNIFIER—Extends time base to 0.1 μ s/div.

CALIBRATED SWEEP DELAY—10 μ s to 50 s.

EXTERNAL INPUT—Approx 100 mV/div to 30 V/div.

CRT

DISPLAY AREA—10 x 10 cm (each beam scans 8 cm vertical, overlap of the two beams is 6 cm). Major graticule division equals 1 cm, minor division equals 2 mm. Illuminated no-parallax graticule.

ACCELERATING VOLTAGE—4 kV.

PHOSPHOR—P2

OTHER

AMPLITUDE CALIBRATOR—1 mV to 100 V, 1-kHz square wave.

REAR-PANEL SIGNAL OUTPUTS—Output impedance approx 500 ohms; max load 2 mA.

POWER REQUIREMENTS—105 to 125 V or 210 to 250 V, 600 watts.

VERTICAL DEFLECTION

2 identical systems

Characteristics of the two vertical systems depend upon the 2-Series or 3-Series Amplifier Units used. Please refer to the plug-in chart for more information on these vertical amplifier units. (The 565 does not use Sampling or Spectrum Analyzer Plug-In Units.)

VERTICAL PLUG-IN UNITS*			
PLUG-IN UNIT	MINIMUM DEFLECTION FACTOR	BANDWIDTH (-3 dB)	T_R
MULTIPLE TRACE			
3A1 Dual-Trace	10 mV/div	DC to 10 MHz	35 ns
3A3 Dual Trace	100 μ V/div	DC to 500 kHz	0.7 μ s
3A6 Dual-Trace	10 mV/div	DC to 10 MHz	35 ns
3A72 Dual-Trace	10 mV/div	DC to 650 kHz	0.54 μ s
3A74 Four-Trace	20 mV/div	DC to 2 MHz	0.18 μ s
SINGLE TRACE			
2A60	50 mV/div	DC to 1 MHz	0.35 μ s
3A5	10 mV/div	DC to 15 MHz	23 ns
Automatic/Prog.	1 mV/div	DC to 5 MHz	
3A75	50 mV/div	DC to 4 MHz	90 ns
SPECIAL PURPOSE			
3A8 Operational	20 mV/div	DC to 3.5 MHz	100 ns
3C66 Carrier Amp.	10 μ strain/div	DC to 5 kHz	70 μ s
DIFFERENTIAL			
2A61 High-Gain	10 μ V/div	0.06 Hz to 300 kHz	1.2 μ s
2A63	1 mV/div	DC to 300 kHz	1.2 μ s
3A3	100 μ V/div	DC to 500 kHz	0.7 μ s
3A7 Comparator	1 mV/div	DC to 10 MHz	35 ns

*2- and 3-Series Time Base Plug-Ins can be used for raster generation.

HORIZONTAL DEFLECTION

2 identical systems

TIME BASE A AND B

1 μ s/div to 5 s/div in 21 calibrated steps, 1-2-5 sequence; accurate within 3%. Uncalibrated, continuously variable and to approx 12 s/div. A warning light indicates when the variable control is in the uncalibrated position. Either time-base can be operated independently, or Time Base B can be delayed by Time Base A. In delayed-sweep operation, Time Base A display is intensified for the duration of the "B" sweep.

X10 MAGNIFIER

Operates over full time base, increases fastest rate to 0.1 μ s/div. Magnified time base accurate within 5%.

DELAY INTERVAL

10 μ s to 50 s, continuously variable and calibrated, accurate within 3% of indicated delay. Incremental delay-time accurate within 0.5%. Delay-time jitter is 1 part in 20,000 or less.

DELAY MODES

Delayed sweep starts immediately at end of delay time, or is triggerable at end of delay time (for jitter-free displays).

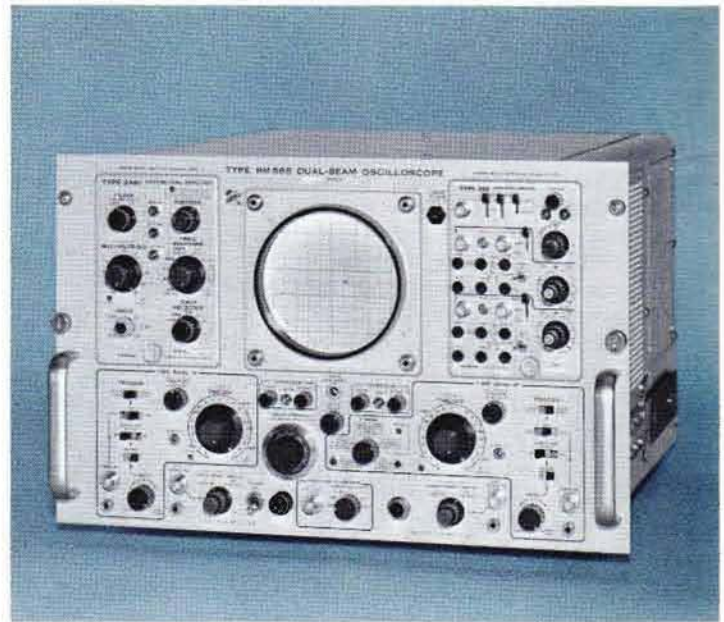

OPERATING MODES

Time Base A—Normal Sweep.

Time Base B—Normal, B delayed by A, and Single Sweep.

EXTERNAL INPUT

Upper and Lower Horizontal Display Switches select Time Base A, Time Base B, or Ext. In the External position, the gain is continuously variable from approx 100 mV/div to 30 V/div, DC to 350 kHz. Maximum input voltage is 300 V RMS. Input RC is approx 100 kilohms paralleled by 30-55 pF depending on gain setting.

TRIGGER

2 identical systems

MODES

Manual, Automatic, Free-run. In Automatic mode, sweep free-runs at approx 50 Hz in the absence of a triggering signal.

COUPLING

AC, AC Fast, DC.

SOURCES

Internal from Upper Beam or Lower Beam, External, or Line.

REQUIREMENTS

0.2 divisions of deflection internal or 0.5 V external up to 50 kHz, increasing to 1 div or 1 V at 2 MHz.

CRT AND DISPLAY FEATURES

TEKTRONIX DUAL-BEAM CRT

5-in round tube, 10 x 10 cm display area; 8 x 10 cm per beam with 6-cm overlap. Tube is aluminized with illuminated, internal, no-parallax graticule. Accelerating potential is 4 kV. P2 phosphor is normally supplied.

DISPLAY CONTROLS

Separate intensity, focus and astigmatism controls for each beam, intensity contrast between A sweep and non-intensified B-zone of A sweep (internal screwdriver adjustment), trace rotation.

Z-AXIS MODULATION

AC-coupled to both CRT grids via rear panel input connectors. Time constant is 3.5 ms nominally, CRT modulation requires approx 10 V at normal intensity.

TYPE **565** **RM565**

OTHER CHARACTERISTICS

AMPLITUDE CALIBRATOR

1-kHz squarewave output, calibrated in 6 steps from 1 mV to 100 V. Accurate within 3%.

REAR-PANEL OUTPUTS

VERTICAL SIGNAL OUT (both upper and lower)—Signal amplitude, DC level, and transient response depend on the vertical plug-in unit used. Typical signal amplitude: 2 V/div to 4 V/div of display; DC level ± 20 V. Output impedance: approx 500 ohms; maximum load current 2 mA.

HORIZONTAL OUTPUTS (both upper and lower)—Signal amplitude, at least 50 mV/div of display in External position and 0.5 V/div of display in Sweep position. DC level 0 to +5 volts. Output impedance: approx 500 ohms; maximum load current 2 mA.

A AND B +GATES—Pulse height 20 V minimum; DC level zero volts. Output impedance: approx 500 ohms; maximum load current 2 mA.

DELAYED TRIGGER—Fast-rise pulse amplitude +8 V minimum; DC level zero volts. Output impedance: approx 50 ohms; maximum load current 2 mA.

POWER REQUIREMENTS

600 watts maximum, 50 to 60 Hz. Instrument factory wired for 105 V to 125 V (117-V nominal) operation, or 210 V to 250 V (234-V nominal) upon request. Transformer taps permit operation at nominal voltages ranging from 99 V to 132 V or 198 V to 265 V.

CABINET MODEL DIMENSIONS AND WEIGHTS

Height	13 $\frac{3}{4}$ in	34.9 cm
Width	16 $\frac{7}{8}$ in	42.8 cm
Depth	23 $\frac{7}{16}$ in	59.8 cm
Net weight	67 lb	30.5 kg
Domestic shipping weight	≈ 95 lb	≈ 43.2 kg
Export-packed weight	≈ 117 lb	≈ 53.2 kg

RACK MODEL DIMENSIONS AND WEIGHTS

Height	12 $\frac{1}{4}$ in	31.1 cm
Width	19 in	48.3 cm
Rack depth	22 $\frac{3}{16}$ in	56.4 cm
Net weight	68 lb	30.9 kg
Domestic shipping weight	≈ 104 lb	≈ 47.3 kg
Export-packed weight	≈ 124 lb	≈ 56.4 kg

RACK-MOUNTING

Type RM565 mounts on tilting slide-out tracks to standard 19-inch rack. Additional mounting information on catalog instrument dimension page.

INCLUDED STANDARD ACCESSORIES

3 to 2-wire adapter (103-0013-00); 3-conductor power cord (161-0010-03); smoke gray filter (installed) (378-0567-00); clear CRT protector plate (387-0918-00); two patch cords, BNC-to-BNC 18-inch (012-0087-00); post jack, BNC (012-0092-00); two instruction manuals (070-0269-00). Type RM565 also includes 1 pair mounting tracks (351-0086-00); power cord (161-0024-01); two instruction manuals (070-0353-00).

OPTIONAL ACCESSORIES

Optional accessories increase measurement capability and provide added convenience. The probes recommended for use with these instruments are covered on the 2- and 3-series plug-in unit pages. Additional probes are available that may be better suited for a particular application, including current and high-voltage measurements. See the catalog accessory pages for information on these and other items.

CAMERAS

C-27-547: f/1.9—1:0.7 lens, Polaroid Land¹ Pack Film back provides 10 x 10-cm coverage on 3 $\frac{1}{4}$ x 4 $\frac{1}{2}$ film

C-27G: f/1.9—1:0.85 lens, no back, provides 10 x 10-cm coverage on 4 x 5 film with optional Graflok² back and Polaroid Land film holder

Graflok back for 4 x 5 film holder (not included), order 122-0604-00

Type 565, RM565 to C-27-547 or C-27G Camera adapter, order 016-0225-00

SCOPE-MOBILE[®] CART

Model 205-3: holds 4 plug-in units, has 9-position tilt-lock oscilloscope tray

CRADLE ASSEMBLY

Provides rear slide support when RM565 is mounted in backless rack, order 040-0346-00

¹Registered Trade-Mark Polaroid Corporation.

²Registered Trade-Mark Graflex Inc.

Please refer to Terms and Shipment, General Information page.

TYPE 2A60

DC-to-1 MHz AMPLIFIER UNIT

- **DC TO 1 MHz BANDWIDTH**
- **50 mV/DIV TO 50 V/DIV CALIBRATED DEFLECTION FACTOR**
- **LOW COST**

The Type 2A60 is a general-purpose plug-in unit. It may be used in the Type 561A, Type 564, Type 565, and in the Type 567/6R1A or Type 568/230 Oscilloscope without digital read-out. Used with the Type 129 Power Supply, the Type 2A60 can drive recorders, X-Y plotters, oscilloscopes, and other indicators.

BANDWIDTH

DC to 1 MHz at 3-dB down. AC-coupled low-frequency response is 2 Hz, 0.2 Hz with 10X probe.

RISETIME

0.35 μ s.

DEFLECTION FACTOR

0.05 V/div, 0.5 V/div, 5 V/div and 50 V/div. Calibrated accuracy within 3%. Uncalibrated, continuously variable between steps and to approx 500 V/div.

INPUT RC

1 megohm paralleled by approx 47 pF.

MAXIMUM INPUT VOLTAGE

600 V combined DC + peak AC.

WEIGHTS

Net weight	3 lb	1.4 kg
Domestic shipping weight	\approx 6 lb	\approx 2.7 kg
Export-packed weight	\approx 10 lb	\approx 4.5 kg

INCLUDED STANDARD ACCESSORIES

Two instruction manuals (070-0263-00).



OPTIONAL ACCESSORIES

The probes recommended for use with this instrument satisfy most measurement requirements. Additional probes are available that may be better suited for a particular application, including high-voltage and current measurements. See catalog accessory pages for information on these and other items.

P6028 1X Probe Package, order 010-0074-00

P6006 10X Probe Package, order 010-0127-00

P6007 100X Probe Package, order 010-0150-00

Please refer to Terms and Shipment, General Information page.

TYPE 2A61

HIGH-GAIN AC DIFFERENTIAL UNIT

- 0.06 Hz to 0.3 MHz BANDWIDTH
SELECTABLE HIGH AND LOW 3-dB POINTS
- 10 $\mu\text{V}/\text{DIV}$ to 20 mV/DIV
CALIBRATED DEFLECTION FACTOR
- LOW NOISE
- 50,000:1 COMMON-MODE REJECTION

The Type 2A61 is an AC Differential Amplifier with excellent common-mode rejection and high-gain characteristics for low-level applications.

Differential input permits measurements where the output is proportional to the difference between signals applied through the included cable. Differential operation is useful for measurements between two above-ground points, and for cancellation of in-phase signals such as hum pickup at the signal source. Separate high-frequency and low-frequency response controls on the front panel of the unit restrict the bandwidth, thus increasing the signal-to-noise ratio.

The Type 2A61 may be used in the Type 561A, Type 564, Type 565, and in the Type 567/6R1A or Type 568/230 Oscilloscope without digital readout. Used with the Type 129 Power Supply, the Type 2A61 can drive recorders, X-Y plotters, oscilloscopes, and other indicators.

BANDWIDTH

0.06 Hz to 0.3 MHz at all deflection-factor settings except 0.01 mV/div (0.1 Hz to 0.1 MHz). Bandwidth is specified at 3-dB down. A FREQUENCY RESPONSE switch selects high and low-frequency 3-dB points.

HIGH-FREQUENCY 3-dB POINTS

60 Hz, 600 Hz, 6 kHz, 60 kHz and 0.1 to 0.3 MHz.

LOW-FREQUENCY 3-dB POINTS

0.06 to 0.1 Hz, 0.6 Hz, 6 Hz and 600 Hz.

DEFLECTION FACTOR

10 $\mu\text{V}/\text{div}$ to 20 mV/div in 11 calibrated steps, 1-2-5 sequence; accurate within 5%. Uncalibrated, continuously variable between steps and to approx 50 mV/div.

INPUT RESISTANCE

10 megohms, each input to ground.

OPERATING MODES

Input A only, negative Input B only; Input A minus Input B, CM [common mode for checking common mode rejection ratio].

COMMON-MODE REJECTION

50,000:1 below 10 kHz with a 5-V peak-to-peak sinewave input.



DIFFERENTIAL INPUT DC BIAS

± 0.1 V maximum, at all deflection factors.

LINE-FREQUENCY NOISE FILTER

Notch filter provides better than 50-to-1 rejection of 60 Hz line-frequency noise. The instrument can also be ordered with a 50 Hz line-frequency filter. Order MOD 156M.

EQUIVALENT INPUT SHORT-CIRCUIT NOISE

Less than 3.5 μV RMS (approx 20 μV peak-to-peak) at maximum bandwidth and 0.01 mV/div deflection factor.

TRACE RESTORER

Pushbutton returns trace to its normal vertical position if driven off the screen.

WEIGHTS

Net weight	5 lb	2.3 kg
Domestic shipping weight	≈ 9 lb	≈ 4.1 kg
Export-packed weight	≈ 12 lb	≈ 5.5 kg

INCLUDED STANDARD ACCESSORIES

Two instruction manuals (070-0328-01); input cable (012-0072-00).

Please refer to Terms and Shipment, General Information Page

TYPE 2A63

DIFFERENTIAL AMPLIFIER UNIT

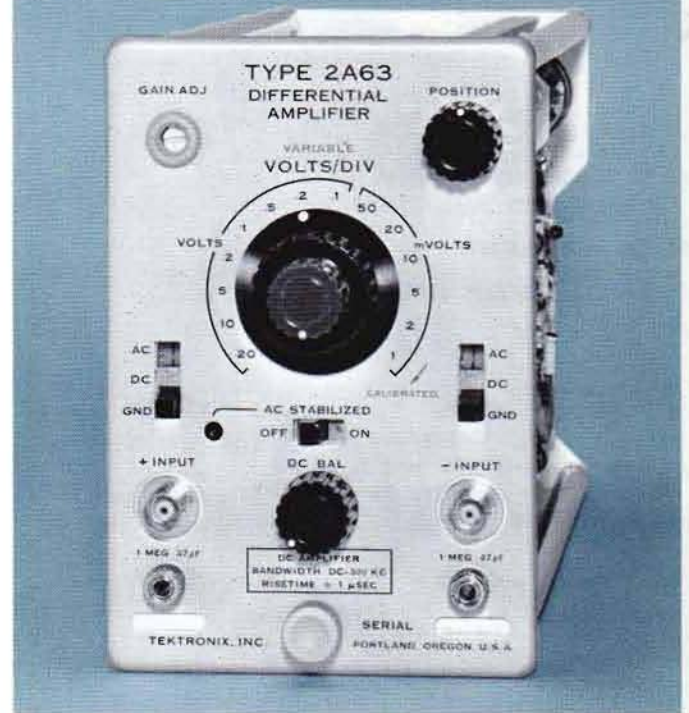

- UP TO 250:1 CMRR
- 1 mV/DIV TO 20 V/DIV CALIBRATED DEFLECTION FACTOR

The Type 2A63 is a differential amplifier plug-in unit. It can be used to make voltage measurements between two above-ground points while at the same time cancelling in-phase signals such as hum pickup in the connecting leads.

The Type 2A63 may be used in the Type 561A, Type 564, Type 565, or Type 567/6R1A and Type 568/230 Oscilloscope without digital readout. Used with the Type 129 Power Supply, the Type 2A63 can drive recorders, X-Y plotters, oscilloscopes, and other indicators.

BANDWIDTH

DC to 300 kHz at 3-dB down. AC-coupled low-frequency response is 2 Hz, 0.2 Hz with 10X probe.

RISETIME

≤ 1.2 μs.

DEFLECTION FACTOR

1 mV/div to 20 V/div in 14 calibrated steps, 1-2-5 sequence; accurate within 3%. Uncalibrated, continuously variable between steps and to approx 50 V/div.

INPUT RC

1 megohm paralleled by approx 47 pF.

MAXIMUM INPUT VOLTAGE

600 V combined DC + peak AC.

DIFFERENTIAL INPUT

DEFLECTION FACTOR	CMRR*	
	1 kHz	50 kHz
1 mV/cm to 50 mV/cm	250:1	150:1
0.1 V/cm to 20 V/cm	25:1	25:1

*With a maximum sine wave amplitude of 5 V P-P.

PHASE SHIFT

Phase shift between two Type 2A63 Units used for X-Y displays is nominally less than 1° at 50 kHz.

INTER-STAGE AC COUPLING

Reduces drift at high gain.

WEIGHTS

Net weight	3 ³ / ₄ lb	1.7 kg
Domestic shipping weight	≈ 7 lb	≈ 3.2 kg
Export-packed weight	≈ 11 lb	≈ 5.0 kg

INCLUDED STANDARD ACCESSORIES

Two instruction manuals (070-0266-00).

OPTIONAL ACCESSORIES

The probes recommended for use with this instrument satisfy most measurement requirements. Additional probes are available that may be better suited for a particular application, including high-voltage and current measurements. See catalog accessory pages for information on these and other items.

P6028 1X Probe Package, order 010-0074-00

P6023 10X Probe Package, adjustable attenuation helps maintain common-mode rejection, order 010-0167-00

P6007 100X Probe Package, order 010-0150-00

Please refer to Terms and Shipment, General Information Page.

TYPE 2B67

TIME-BASE UNIT

- **1 μ s/DIV TO 5 s/DIV CALIBRATED TIME BASE**
- **5X MAGNIFIER**
- **SINGLE SWEEP OPERATION**
- **LOW COST**

The Type 2B67 Time-Base Unit is designed to generate a sweep in the Type 561A and Type 564.

The unit is recommended for use with 2- and 3-series vertical plug-in units with bandwidths up to 2 MHz.



TIME BASE

1 μ s/div to 5 s/div in 21 calibrated steps, 1-2-5 sequence; accurate within 3%. Uncalibrated, continuously variable between steps and to approx 12 s/div.

5X MAGNIFIER

Operates over full time base, increases the fastest rate to 0.2 μ s/div. Magnified display accurate within 5%.

SINGLE SWEEP

For one-shot waveform photography and storage applications.

EXTERNAL HORIZONTAL INPUT

Approx 1 V/div, DC to 750 kHz at -3 dB.

TRIGGER

MODES

Manual, automatic, or free-run.

COUPLING

AC slow, AC fast, or DC.

SOURCES

Internal, external, or line.

REQUIREMENTS

Internal Triggering—0.4 divisions of display.

External Triggering—0.5 V at DC increasing to 2 V at 2 MHz.

WEIGHTS

Net weight	4 $\frac{1}{4}$ lb	1.9 kg
Domestic shipping weight	\approx 7 lb	\approx 3.2 kg
Export-packed weight	\approx 11 lb	\approx 5.0 kg

INCLUDED STANDARD ACCESSORIES

Two instruction manuals (070-0366-00).

Please refer to Terms and Shipment, General Information Page.

DUAL-TRACE DIFFERENTIAL UNIT

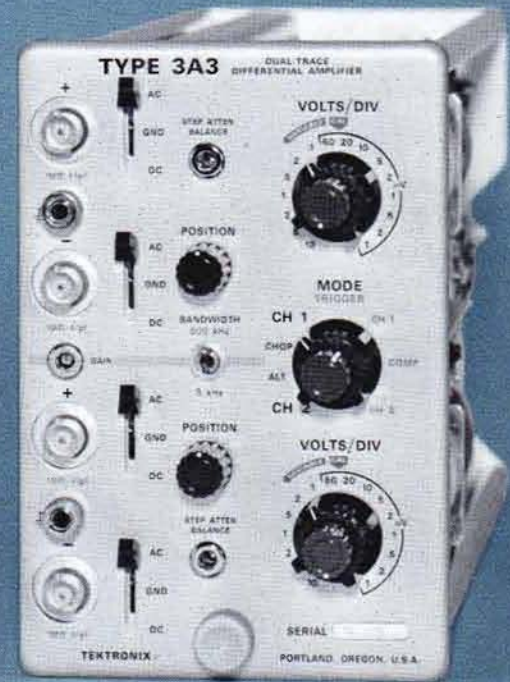

- **100 $\mu\text{V}/\text{DIV}$ TO 10 V/DIV CALIBRATED DEFLECTION FACTOR**
- **50,000:1 COMMON-MODE REJECTION**
- **DC to 500 kHz BANDWIDTH CONSTANT AT ALL DEFLECTION FACTORS**
- **FET INPUTS**

The Type 3A3 Dual-Trace Differential Amplifier is designed for use in the Type 561A, 564, 565, or in the Types 567/6R1A and 568/230 Oscilloscopes without digital readout. Used in the Type 129 Power Supply, the unit can be used to drive X-Y plotters, oscilloscopes, and other indicators.

The Type 3A3 contains two independent, high-gain amplifier channels with identical characteristics. Either channel may be used to produce a display, or the two channels may be electronically switched to produce dual-trace displays. The unit features high sensitivity with direct-coupled inputs and has a high degree of common-mode rejection. A switch on the front panel selects the upper bandwidth limit of the unit, thus increasing the signal-to-noise-ratio.

BANDWIDTH

DC to >500 kHz at 3-dB down. Low-frequency 3-dB point is 2 Hz with AC coupling, 0.2 Hz with 10X probe. A BANDWIDTH switch selects high or low upper 3-dB points: DC to >500 kHz or DC to 5 kHz. Selected bandwidth is constant at all deflection-factor settings.

DEFLECTION FACTOR

100 $\mu\text{V}/\text{div}$ to 10 V/div in 16 calibrated steps, 1-2-5 sequence; accurate within 3%. Uncalibrated, continuously variable between steps and to approx 25 V/div .

INPUT RC

1 megohm paralleled by approx 47 pF. Input R can be disconnected by removing internal wire link.

OPERATING MODES

Channel 1, Channel 2, or dual-trace with Alternate or Chopped switching. In chopped operation, successive 2- μs segments of each channel are displayed at an approx 250-kHz rate. Chopped transient blanking is provided.

DUAL X-Y DISPLAYS

Obtained with two Type 3A3 Plug-In Units. Dual-trace switching is synchronized, so that one Y-channel remains plotted against the same X-channel, once the display is set up. There is no provision for consistent pairing each time the system is operated.

PHASE SHIFT

Less than 2° from DC to 100 kHz between two Type 3A3 Amplifiers used in X-Y operation. Phase shift can be adjusted to 0° at any particular deflection factor setting.

NOISE

Displayed noise, tangentially measured, is less than 15 μV in the 500 kHz bandwidth position.

DRIFT

Less than 50 $\mu\text{V}/^\circ\text{C}$.

INTERCHANNEL ISOLATION

Electrostatic Isolation is $10^6:1$ or better referred to input signal levels. Dual-Trace Isolation in alternate or chopped operation is 100:1 or better referred to divisions of display. Example: 5 divisions displayed on channel 1 will cause no more than 0.05 divisions of deflection on channel 2.

TRIGGER PICKOFF

Internally coupled. Can be selected from Channel 1, Channel 2 or the composite signal after switching.

TYPE 3A3

DIFFERENTIAL CF OUTPUTS

Output is available from two of the connector pins at the rear of the plug-in for use in driving recorders or other equipment. Output amplitude is a ground-reference, differential, ≈ 5 -volt signal for each division of displayed signal. Front-panel TRIGGER SWITCH allows signal out selection of CH 1, CH 2 or composite. Bandwidth is DC to ≈ 500 kHz with a non-capacitive load. Jacks can be easily installed at the rear of the oscilloscope to provide access to the CF outputs.

WEIGHTS

Net weight	$5\frac{3}{4}$ lb	2.6 kg
Domestic shipping weight	≈ 10 lb	≈ 4.5 kg
Export-packed weight	≈ 14 lb	≈ 6.4 kg

INCLUDED STANDARD ACCESSORIES

Four BNC-to-binding post adapters (103-0033-00); two BNC-to-BNC 18-in patch cords (012-0087-00); two instruction manuals (070-0408-01).

OPTIONAL ACCESSORIES

The probes recommended for use with this instrument satisfy most measurement requirements. Additional probes are available that may be better suited for a particular application, including high-voltage and current measurements. See catalog accessory pages for information on these and other items.

P6028 1X Probe Package, order 010-0074-00

P6023 10X Probe Package, adjustable attenuation ratio helps maintain common-mode rejection, order 010-0167-00

P6007 100X Probe Package, order 010-0150-00

Please refer to Terms and Shipment, General Information page.

COMMON-MODE REJECTION [Ⓐ]				
0.1 mV/div to 10 mV/div [Ⓑ]				
	Referred to Input Connectors		Referred to Input of Properly Adjusted P6023 Probes	
	DC-Coupled Input	AC-Coupled Input With Low-Z Source	DC-Coupled Input	AC-Coupled Input With Low-Z Source
DC to 100 kHz	50,000:1			
500 kHz	1,000:1	1,000:1		
DC to 10 Hz			50,000:1	
15 Hz		500:1		
60 Hz		2,000:1		
100 Hz			10,000:1	
1 kHz to 10 kHz			1,000:1	1,000:1
100 kHz		50,000:1	500:1	500:1
20 mV/div to 10 V/div [Ⓒ]				
(Equal to, or adjustable to, the following minimum CMR ratios.)				
DC to 1 kHz	5,000:1			
1 kHz to 100 kHz	1,000:1			
500 kHz	500:1	500:1		
15 Hz		500:1		
60 Hz		2,000:1		

[Ⓐ]For ground-reference sine-wave common-mode signals.
[Ⓑ]With ± 5 V or less from ground, in common mode at input connectors.
[Ⓒ]With common-mode amplitude at input connectors of ± 50 V or less from ground, from 20 mV/div to 0.1 V/div, and with ± 350 V or less from ground, from 0.2 V/div to 10 V/div.

AUTO/PROGRAMMABLE AMPLIFIER UNIT



- **23-ns RISE TIME**
- **AUTOMATIC SENSITIVITY "SEEKING"**
- **PROGRAMMABLE FRONT-PANEL FUNCTIONS**
- **LIGHTED INDICATION OF MEASUREMENT PARAMETERS**

The Type 3A5 is an automatic plug-in unit designed for use in Type 561A and 564 Oscilloscopes. Press the "seek" button on the special 10X probe and the instrument selects the deflection factor for a convenient display size. This "seek" feature is ideal for applications where the instrument is located out of reach, or for production-line testing that requires continuous readjustment of the volts/division control.

Upon receipt of the "seek" command, the deflection factor is automatically selected so that neither peak of the displayed waveform extends more than 3 divisions from the graticule center, thus establishing the display within the CRT viewing area. Large, lighted indicators in the front-panel window tell you at a glance the volts/division setting, input coupling, and when the manual variable volts/division control is in the uncalibrated position.

The Type 3A5 can be operated manually for applications that do not require the automatic features. In addition, the automatic functions are overridden whenever the manual V/div setting is changed. The plug-in can also be operated remotely using the Type 263 External Programmer. Both the "seek" feature and manual operation of the control settings are overridden when the instrument is programmed externally.

Other features of the Type 3A5 include a special "AC Trace Stabilized" circuit that minimizes trace drift. This feature is particularly useful when the instrument is operated at high sensitivity or when long term trace-stability is required.

OPERATING MODES

SEEK, MANUAL AND EXTERNAL

Seek operation selected by front-panel pushbutton or pushbutton on the P6030 Probe. Manual or external operation selected by front-panel pushbuttons.

SEEKING CHARACTERISTICS

DEFLECTION FACTOR

10 mV/div to 50 V/div without probe; 0.1 V/div to 500 V/div with P6030 probe.

SEEKING TIME

≤200 ms. (Time required to complete one "seek" operation).

CYCLING TIME

2 to 4 s (interval between seek operations with "seek" command button held down continuously).

LOGIC CIRCUIT RESPONSE

Seeking circuitry functions for signal rep-rates up to 20 MHz.

GENERAL CHARACTERISTICS

READOUT FACILITY

Bulb-and-film digits 1/2 inch high. Readout information includes 1 mV/div to 50 V/div (10 mV/div to 0.5 kV/div when special 10X probe activates the 10X circuit); "AC" or "DC" input coupling, "with probe" indication, and "uncal" indication when using the variable manual V/div control.

DEFLECTION FACTOR

10 mV/div to 50 V/div in 12 calibrated steps, 1-2-5 sequence; accurate within 3%. Additional steps of 1, 2 and 5 mV/div in manual mode only; accurate within 5%. A manual control provides uncalibrated variable V/div settings between all steps.

BANDWIDTH

DC to ≥15 MHz at 3-dB down, from 10 mV/div to 50 V/div (all modes). DC to ≥5 MHz at 1, 2 or 5 mV/div (manual mode only). AC-coupled low-frequency response is 5 Hz, 0.5 Hz with included 10X probe.

RISETIME

≤23 ns at deflection factors of 10 mV to 50 V/div.

INPUT RC

1 megohm paralleled by approx 24 pF.

SIGNAL DELAY

Permits viewing the leading edge of fast-rise waveforms.

PROGRAMMABLE FUNCTIONS

V/div settings, with or without 10X probe, AC or DC input coupling, AC Trace Stabilization, all by contact closure to ground. Vertical positioning by variable resistance.

P6030 PROBE

10X probe with "seek" command button and 6-ft cable. Supplied with the instrument.

WEIGHTS

Net weight	5 1/4 lb	2.4 kg
Domestic shipping weight	≈11 lb	≈5.0 kg
Export-packed weight	≈14 lb	≈6.4 kg

INCLUDED STANDARD ACCESSORIES

P6030 10X Probe Package (010-0195-00); 37-pin connector (131-0422-00); connector cover (200-0660-02); telephone plug (134-0079-00); two instruction manuals (070-0500-00).

Please refer to Terms and Shipment, General Information page.

TYPE 3B5

AUTOMATIC/PROGRAMMABLE TIME-BASE UNIT

- AUTOMATIC TIME-BASE "SEEKING"
- PROGRAMMABLE FRONT-PANEL FUNCTIONS
- LIGHTED INDICATION OF MEASUREMENT PARAMETERS
- DELAYED SWEEP MAGNIFIER

Used in association with the Type 3A5 Amplifier and P6030 Probe, the Type 3B5 automatically establishes a triggered time-base display upon receipt of the "seek" command from the probe. The time/division setting is automatically selected to provide a convenient display of 2 to 6 cycles. Lighted indicators in the front-panel window show the selected time/division setting. They also indicate when the time base is not triggered and when the manual variable time/division control is in the uncalibrated position.

The Type 3B5 features a delayed sweep magnifier for expanding the display by X10 or X100. A calibrated delay control selects the point in the display where magnification begins. When the sweep magnifier is in operation, the time/division readout is automatically corrected to indicate the magnified setting, and a "magnified sweep" indication lights up in the readout window.

The automatic "seek" feature of the Type 3B5 is overridden when the manual time/division control is used. Both the "seek" feature and manual operation of the control setting are overridden when the instrument is programmed remotely using the Type 263 External Programmer.

OPERATING MODES

SEEK, MANUAL AND EXTERNAL

Manual or external operation selected by front-panel push-buttons. Seek operation selected by front-panel pushbutton or pushbutton on the P6030 Probe supplied with the Type 3A5 Amplifier.

SEEKING CHARACTERISTICS

TIME BASE

5 s/div to 0.1 μ s/div.

SEEKING TIME

≤ 500 ms (time required to complete one "seek" operation).

CYCLING TIME

2 to 4 s ("seek" command button held down continuously).

LOGIC CIRCUIT RESPONSE

Seeking circuitry functions for signal rep-rates from 30 Hz to 20 MHz.

GENERAL CHARACTERISTICS

READOUT FACILITY

Bulb-and-film digits $\frac{1}{2}$ inch high. Readout information includes 5 s/div to 10 ns/div sweep times, plus "Magnified Sweep," "Not Triggered," and "Uncalibrated" indications.

TIME BASE

10 ns/div to 5 s/div in 27 calibrated steps, 1-2-5 sequence. Accurate within 3% from 0.1 μ s/div to 1 s/div; within 5% at 10, 20, or 50 ns/div and at 2 or 5 s/div. A manual control provides uncalibrated variable time/div settings between all steps and to approx 12.5 s/div.

DELAYED SWEEP MAGNIFIER

Expands the display by a factor of X10 or X100. X10 range magnifies time/division settings from 5 s/div to 1 μ s/div.

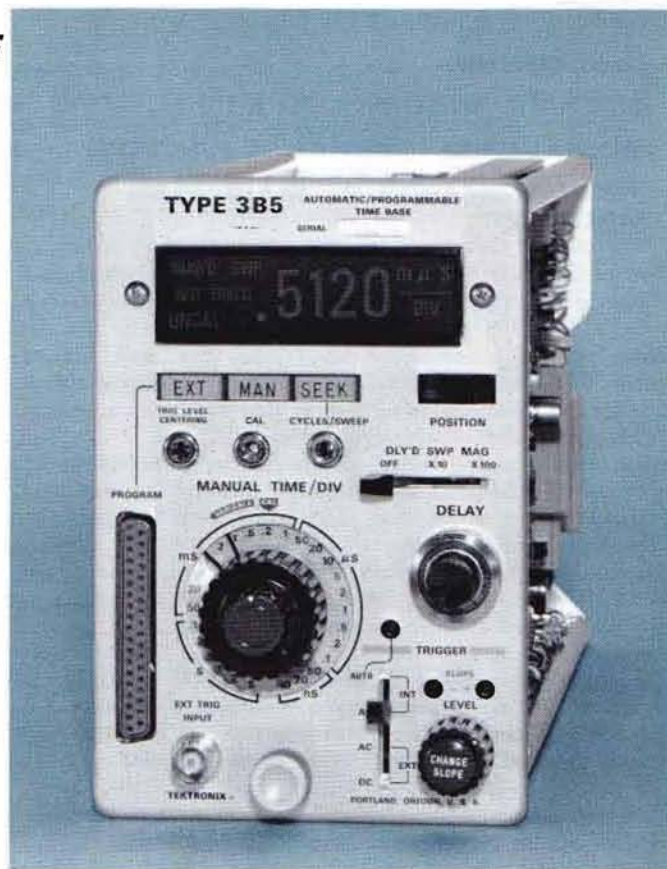

X100 range magnifies time/division settings from 5 s/div to 10 μ s/div. Accuracy is within 3% for all magnified sweep times except the 5 and 2 s/div (within 5%). VARIABLE DELAY: 10-turn control determines portion of sweep to be magnified.

TRIGGER MODES

Internal: AC-coupled or Auto. External: AC-coupled or DC-coupled.

TRIGGER REQUIREMENTS

Internal AC, Auto (with Type 3A5): 0.5 div of signal displayed, 50 Hz to 8 MHz, increasing to 2 div at 20 MHz.

External AC: 1 V to 40 V peak to peak, 50 Hz to 20 MHz.

External DC: 2.5 V to 40 V peak to peak, DC to 10 Hz; 1 V to 40 V peak to peak, 10 Hz to 20 MHz.

PROGRAMMABLE FUNCTIONS

Time/div, magnifier range, trigger-mode, slope, and coupling, by contact closure to ground. Horizontal positioning, trigger level, and magnifier delay by variable resistance.

WEIGHTS

Net weight	5 lb	2.3 kg
Domestic shipping weight	≈ 11 lb	≈ 5.0 kg
Export-packed weight	≈ 14 lb	≈ 6.4 kg

INCLUDED STANDARD ACCESSORIES

37 pin connector (131-0422-00); connector cover (200-0660-01); two instruction manuals (070-0538-00).

Please refer to Terms and Shipment, General Information page.

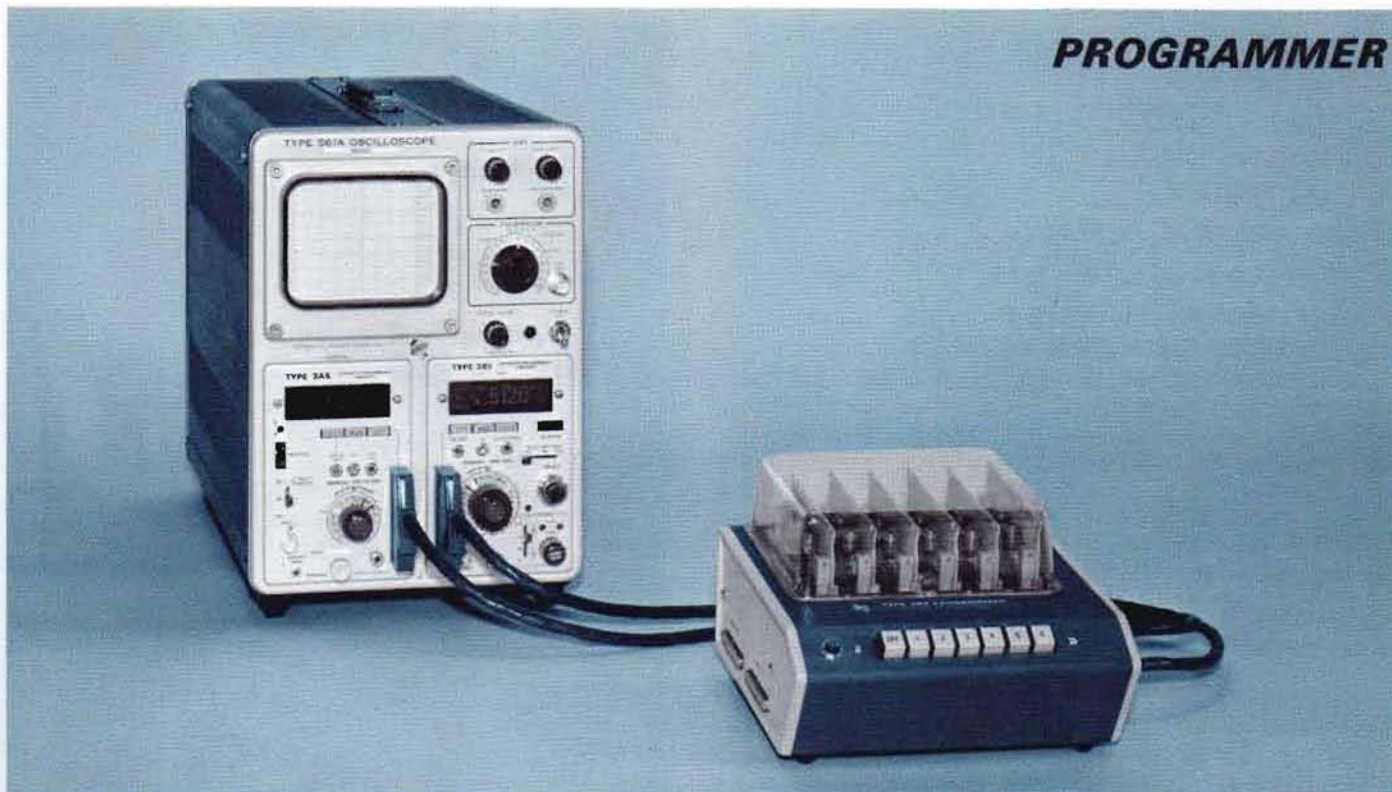

COMPLETE SYSTEM FOR FAST PRODUCTION-LINE TESTING

- **FAST AMPLITUDE AND TIME MEASUREMENTS**
- **REDUCED OPERATOR ERROR**
- **SIMPLE, CONVENIENT OPERATION**

The Type 561A Oscilloscope* combined with the Type 3A5, 3B5 Plug-In Units and the Type 263 Programmer, offers the ideal system for making production-line measurements quickly and conveniently . . . and with less chance for operator error. The system allows measurements to be made at the push of a button without changing the manual controls of either plug-in unit. The oscilloscope settings are programmed for a particular measurement and read out in large, lighted indicators on the face of the plug-in units. After the initial program is established, this new system can be operated by personnel with little or no technical training.

The Type 263 Programmer provides the facility for controlling the Type 3A5 and 3B5 Automatic/Programmable Plug-In Units remotely. Pushbuttons on the front panel of the Programmer select any one of six internal program cards. Each card, after initial set-up, establishes the plug-in functions required for a particular test or measurement. More than one programmer can be cascaded for applications requiring more than the six initial measurement set-ups. The plug-in type program cards are identical, allowing them to be interchanged or arranged in any sequence. New programs are easily established by relocating small jumpers and changing the potentiometer settings on the cards.

*Also Type 564 Oscilloscope for storage applications.

TYPE 263 CHARACTERISTICS

PROGRAM CAPABILITIES

All operational controls of the Type 3A5 and Type 3B5 are programmable except the variable volts/division and time/division functions. Program established by jumper placement and potentiometer setting on the program cards.

OUTPUT CABLES

Two 3 ft cables with multi-pin connectors.

CONSTRUCTION

Cast aluminum with wrap-around steel cabinet. Blue vinyl finish.

DIMENSIONS AND WEIGHTS

Height	5 ³ / ₄ in	14.6 cm
Width	8 ³ / ₄ in	22.2 cm
Depth	9 in	22.9 cm
Net weight	5 ¹ / ₂ lb	2.5 kg
Domestic shipping weight	≈12 lb	≈5.5 kg
Export-packed weight	≈18 lb	≈8.2 kg

INCLUDED STANDARD ACCESSORIES

Eleven electrical leads (175-0674-00); two instruction manuals (070-0535-00).

Please refer to Terms and Shipment, General Information page.

TYPE 3A6

DC-to-10 MHz DUAL-TRACE UNIT

- 35-ns RISETIME
- TWO IDENTICAL CHANNELS
- DC TO 10 MHz BANDWIDTH
- 10 mV/DIV TO 10 V/DIV CALIBRATED DEFLECTION FACTOR

The Type 3A6 Amplifier is a general-purpose, dual-trace plug-in unit designed for use in the Types 561A, 564 and 565 Oscilloscopes. It can also be used in the Type 567/6R1A or Type 568/230 when digital readout is not required.

The Type 3A6 features two separate channels with identical characteristics. It can be operated in any one of five modes for a variety of single and dual-trace displays. Two Type 3A6's can be used for X-Y curve tracing, but without synchronized switching or channel pairing.

BANDWIDTH

DC to 10 MHz at 3-dB down. AC-coupled low-frequency response is 2 Hz, 0.2 Hz with 10X probe.

RISETIME

Approximately 35 ns.

DEFLECTION FACTOR

10 mV/div to 10 V/div in 10 calibrated steps, 1-2-5 sequence; accurate within 3%. Uncalibrated, continuously variable between steps and to approx 25 V/div.

INPUT RC

1 megohm paralleled by approx 47 pF.

MAXIMUM INPUT VOLTAGE

600 V combined DC + peak AC.

OPERATING MODES

Includes Channel 1 only (polarity of Channel 1 can be changed to provide 180° inversion); Channel 2 only; alternate—Channel 1 and 2 switched electronically on alternate sweeps; Chopped—successive 4 μ s (approx) segments of each channel are displayed at an approx 125-kHz rate per channel (chopped transient blanking is provided); Added—outputs of Channel 1 and 2 added algebraically.

INTERNAL TRIGGER SIGNAL

Selectable from the output of Channel 1 only or from the combined output of the unit. Triggering from Channel 1 only permits viewing the true relationship between two signals when operating the unit in either alternate or chopped mode.



SIGNAL DELAY

Permits viewing of leading edge of fast-rise waveforms.*

WEIGHTS

Net weight	5 $\frac{3}{4}$ lb	2.6 kg
Domestic shipping weight	\approx 9 lb	\approx 4.1 kg
Export-packed weight	\approx 13 lb	\approx 5.9 kg

INCLUDED STANDARD ACCESSORIES

Two instruction manuals (070-0419-00).

OPTIONAL ACCESSORIES

The probes recommended for use with this instrument satisfy most measurement requirements. Additional probes are available that may be better suited for a particular application, including high-voltage and current measurements. See catalog accessory pages for information on these and other items.

- P6028 1X Probe Package, order 010-0074-00
- P6006 10X Probe Package, order 010-0127-00
- P6007 100X Probe Package, order 010-0150-00

*The Type 3A6 can be used with a Type 2867 or Type 382 Time-Base Unit, but it will not usually be possible to view the entire leading edge of the triggering waveform. Same applies when the unit is used with Types 565 and RM565 Oscilloscopes.

Please refer to Terms and Shipment, General Information Page.

DIFFERENTIAL COMPARATOR UNIT

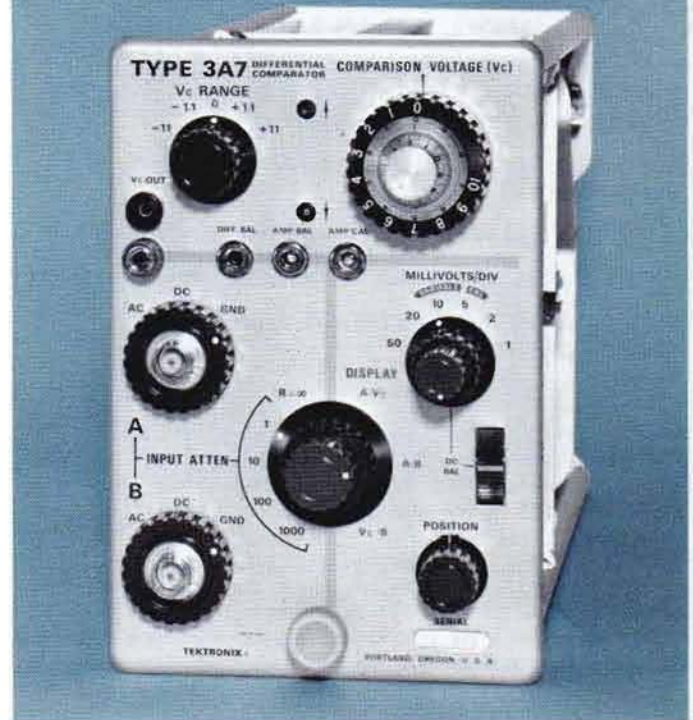

- **1 mV/DIV TO 50 V/DIV CALIBRATED DEFLECTION FACTOR**
- **UP TO 10-MHz BANDWIDTH**
- **20,000:1 COMMON-MODE REJECTION**
- **11,000 cm EFFECTIVE SCREEN HEIGHT**

The Type 3A7 High-Gain Differential Comparator adds to the measurement capabilities of Type 561A, 564, and 565 Oscilloscopes. It can also be used in the Types 567/6R1A and 568/230, but does not provide digital readout. Used with Type 129 Power Supply, the Type 3A7 can drive recording equipment, X-Y plotters, oscilloscopes, or other indicators.

As a differential input amplifier, the dynamic range of the 3A7 Unit permits common-mode signals up to ± 15 volts in amplitude to be applied to the amplifier without attenuation. With a rejection ratio of about 20,000 to 1 for DC or low-frequency signals, differential signals of 1 mV or less on large common-mode signals can be measured. A front-panel attenuator permits the acceptance of common-mode voltages up to 500 V.

As a differential comparator, voltage measurements using the slide-back technique can be made with this unit. The high accuracy and stability of the DC comparison voltage, added differentially to the input signal, makes precise voltage measurements possible. Using this mode of operation, the 3A7 Unit has an effective screen height of $\pm 11,000$ cm. This is equivalent to a ± 11 -volt dynamic signal range at a deflection factor of 1 mV/cm. Within this range, calibrated \pm DC comparison voltages can be added differentially to the input signal to permit a maximum of about 0.001% or 100 μ V per mm to be resolved.

CALIBRATED DEFLECTION FACTOR

1 mV/div to 50 V/div, depending on millivolts/div and attenuator settings. Accuracy of millivolts/div positions is within 3%. Uncalibrated, continuous variation between steps and to approx 125 V/div.

BANDWIDTH (-3 dB)†		
mV/DIV	FREQUENCY	RISETIME
50 mV to 10 mV/div	DC to ≥ 10 MHz	≤ 35 ns
5 mV/div	DC to ≥ 8 MHz	≤ 44 ns
2 mV/div	DC to ≥ 6 MHz	≤ 58 ns
1 mV/div	DC to ≥ 4 MHz	≤ 88 ns

†Low-frequency 3-dB point, AC coupled: 2 Hz, 0.2 Hz with 10X probe.

INPUT CHARACTERISTICS		
INPUT ATTEN	MAX PEAK INPUT VOLTS Common or Differential Mode	MAX INPUT ATTEN ERROR
R $\approx \infty$	± 15 V	*
1X	± 15 V	**
10X	± 150 V	$\pm 0.05\%$
100X	± 500 V	$\pm 0.15\%$
1000X	± 500 V	$\pm 3\%$

*Input R $\approx 10,000$ to 50,000 M Ω .

**1X input R within $\pm 0.1\%$ of 10X input R.

INPUT RC

1 megohm paralleled by approx 20 pF.

COMMON-MODE REJECTION RATIO AT 1 mV/div	
DC COUPLED	$\geq 20,000:1$ with ± 15 VDC or 30 V P to P AC, DC to 20 kHz
AC COUPLED	$\geq 1000:1$ with 30 V P to P at 60 Hz, to $\geq 20,000:1$ at 20 kHz
HF (AC OR DC COUPLED)	$\geq 500:1$ with 30 V P to P at 500 kHz

COMPARISON VOLTAGE

0 to ± 1.1 V, or 0 to ± 11 V. Accuracy: $\pm (0.15\%$ of indicated value plus 0.05% of V_c Range).

OVERDRIVE RECOVERY

Recovers to within 10 mV of reference signal within 300 ns after the signal returns to the screen. Certain overdrive signals can cause an additional slow (thermal) shift of up to 5 mV in the reference level.

WEIGHTS

Net weight	5 $\frac{1}{4}$ lb	2.4 kg
Domestic shipping weight	≈ 9 lb	≈ 4.1 kg
Export-packed weight	≈ 14 lb	≈ 6.4 kg

INCLUDED STANDARD ACCESSORIES

Two instruction manuals (070-0477-00).

OPTIONAL ACCESSORIES

P6028 1X Probe Package, order 010-0074-00

P6023 10X Probe Package, adjustable attenuation ratio helps maintain common-mode rejection, order 010-0167-00

P6007 100X Probe Package, order 010-0150-00

Please refer to Terms and Shipment, General Information page.

TYPE 3A8

OPERATIONAL AMPLIFIER UNIT

- **TWO OPERATIONAL AMPLIFIERS**
- **10 MHz OR GREATER GAIN-BANDWIDTH PRODUCT**
- **15,000 OR GREATER OPEN-LOOP GAIN**
- **SELECTABLE INTERNAL Z_i AND Z_f COMPONENTS**
- **PROVISION FOR EXTERNAL Z_i AND Z_f COMPONENTS**

The Type 3A8 Operational Amplifier performs precise integration, differentiation, function generation, linear and non-linear amplification. The unit can be used in the Type 561A, 564, or Type 565. It can also be used in the Type 567/6R1A and Type 568/230, but without digital presentation of the measurement. Signals from the operational amplifiers can be displayed on the oscilloscope and/or fed to other devices.

Used with the Type 129 Power Supply, the Type 3A8 can drive recorders, X-Y plotters, oscilloscopes, and other indicators.

DISPLAY AMPLIFIER

BANDWIDTH

DC to ≥ 3.5 MHz at 3-dB down.

RISETIME

≤ 100 ns.

DEFLECTION FACTOR

20 mV/div to 10 V/div in 9 calibrated steps, 1-2-5 sequence; accurate within 3%. Uncalibrated, continuously variable between steps and to approx 25 V/div.

INPUT RC

1 megohm paralleled by 47 pF.

OPERATING MODES

Signal source selection from either operational amplifier or an external signal. AC or DC coupling. The display can be inverted to provide the desired deflection polarity.

OPERATIONAL AMPLIFIERS

OPEN-LOOP GAIN

$\geq 15,000$ at DC.

OPEN-LOOP GAIN-BANDWIDTH PRODUCT

≥ 10 MHz.

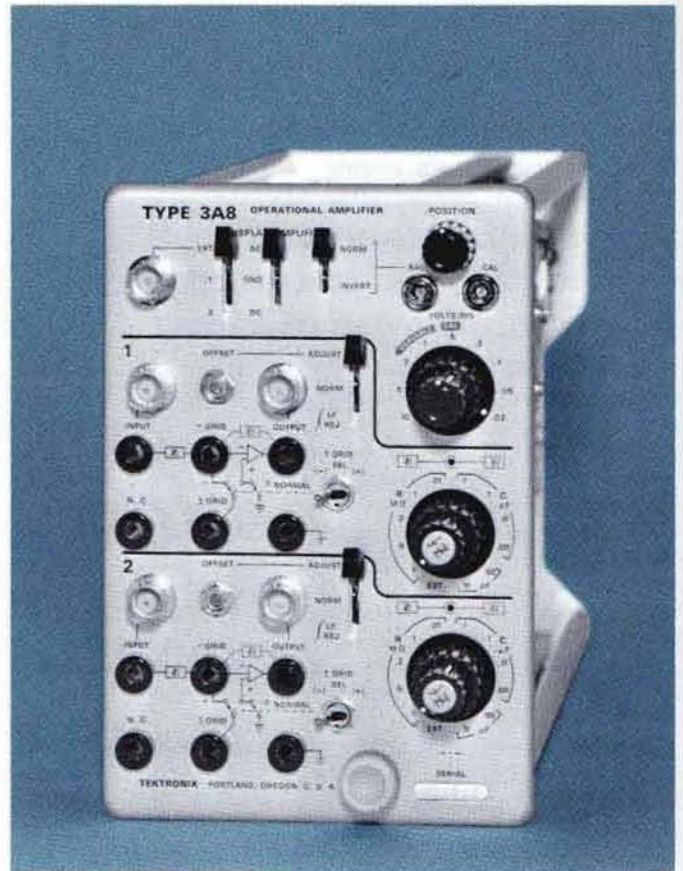

OUTPUT RANGE

± 25 V, ± 7.5 mA. Protected against shorts to ground.

OUTPUT IMPEDANCE

$\leq 30 \Omega$ at 1 MHz for compensated unity-gain amplifier.

INPUT OFFSET

Voltage: adjustable to zero $\pm 500 \mu\text{V}$ (front-panel control).

Current: adjustable to zero ± 50 pA (calibration control).

DRIFT

Typically < 0.5 mV/hour referred to input after 30 minute warmup, averaged over 10 hours.

FEEDBACK

Provisions for negative and/or positive feedback. Negative feedback utilizes internal and/or external impedances; positive feedback utilizes external impedances only.

SELECTABLE INPUT AND FEEDBACK COMPONENTS

Front-panel switches allow independent selection of the following resistors and capacitors in any combination as Z_i and Z_f : 0.01, 0.1, 0.2, 0.5 and 1 megohm; 10 pF, 100 pF, 0.001, 0.01, 0.1 and 1 μF . All values are $\pm 1\%$ except 10 pF and 100 pF which are adjustable.

INTEGRATION LOW-FREQUENCY REJECT

An RC network which prevents integration below approx 1 Hz (voltage or current offset drift) can be switched in or out as needed. Other networks can be connected externally.

OPTIONAL ACCESSORIES

TERMINAL ADAPTERS

Two shielded terminal adapters are included for construction of external circuitry for custom applications. Over one hundred suggested circuits for special applications are shown in the instruction manual.

WEIGHTS

Net weight	4 1/2 lb	≈ 2.0 kg
Domestic shipping weight	≈ 9 lb	≈ 4.1 kg
Export-packed weight	≈ 13 lb	≈ 5.9 kg

INCLUDED STANDARD ACCESSORIES

Two terminal adapters (013-0048-01); two terminal shields (013-0049-01); two BNC to binding post adapters (103-0033-00); two instruction manuals (070-0507-00).

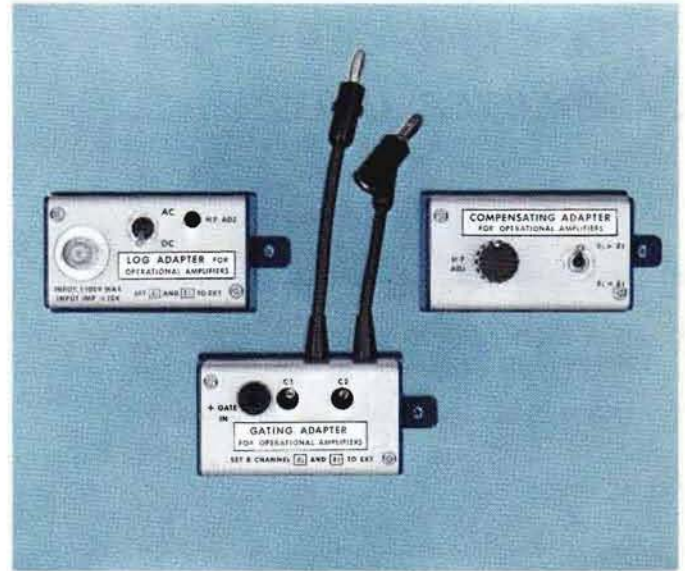

BASIC OPERATING MODES

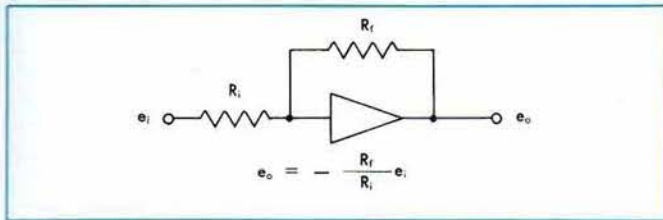

AMPLIFICATION is determined by the ratio of R_f to R_i due to the high open-loop gain. This provides convenient signal step-up or step-down with low output impedance. External compensation extends the closed-loop gain-bandwidth (see Compensating Adapter).

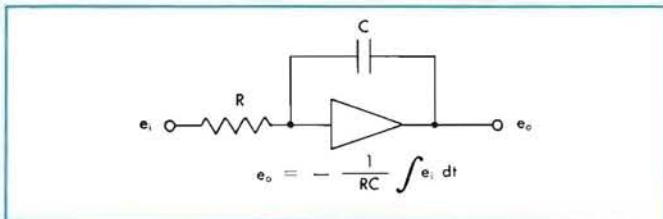

INTEGRATION is obtained by placing a capacitor in the feedback loop. Unlike the passive RC integrator, this circuit permits output loading. Typical applications include magnetic core B-H loop studies.

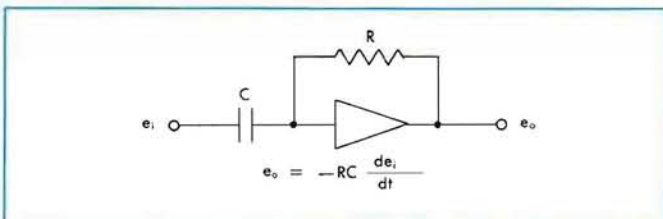

DIFFERENTIATION is accomplished by placing a capacitor in the input circuit. The unique characteristic of this circuit is the extraction of higher frequency signal components without loss of signal level. It can detect minute information such as transients and slope changes.

COMPENSATING ADAPTER

For extending the high-frequency performance of either operational amplifier when the internal Z_i and Z_f resistors are used in any combination for gain or attenuation. The adapter compensates for stray capacitance associated with the internal resistors, providing an adjustment for optimum HF response. Order Part Number 013-0081-00

LOG ADAPTER

Mixed low- and high-amplitude signals can be measured using the Log Adapter. Pulses and transient waveforms spanning three voltage decades to plus 100 volts or minus 100 volts can be displayed and measured on the same trace. Order Part Number 013-0067-00

GATING ADAPTER

The Gating Adapter allows integration and display of repetitive signals by resetting the integrator to zero during sweep retrace time. The adapter uses Operational Amplifier "2" of the Type 3A8 to gate amplifier "1" on and off in response to an external gating signal, such as the +Gate signal from a Type 3B4 Time Base Plug-In Unit. The signal applied to amplifier "1" is then amplified, integrated, or differentiated only during the "on" time. Order Part Number 013-0068-00

Please refer to the catalog accessory pages for complete information on the above adapters.

PROBES

The probes recommended for use with the display amplifier of the Type 3A8 satisfy most measurement requirements. Additional probes are available that may be better suited for a particular application including high-voltage and current measurements. See accessory pages at the rear of the catalog for information on these and other items.

P6028 1X Probe Package, order 010-0074-00

P6006 10X Probe Package, order 010-0127-00

P6007 100X Probe Package, order 010-0150-00

Please refer to Terms and Shipment, General Information page.

TYPE 3A72

DC-to-650 kHz DUAL-TRACE AMPLIFIER UNIT

- TWO IDENTICAL CHANNELS
- 10 mV/DIV TO 20 V/DIV CALIBRATED DEFLECTION FACTOR

The Type 3A72 Amplifier is a general-purpose dual-trace plug-in unit that has two separate channels, each with identical characteristics. The unit can operate in any of five operating modes for a variety of single and dual-trace displays. This unit can be used in the Type 561A, Type 564, or Type 565 Oscilloscope. It can also be used in the Types 567/6R1A and 568/230, but without digital presentation of the measurement.

BANDWIDTH

DC to 650 kHz at 3-dB down. AC-coupled low-frequency response is 2 Hz, 0.2 Hz with 10X probe.

DEFLECTION FACTOR

10 mV/div to 20 V/div in 11 calibrated steps, 1-2-5 sequence; accurate within 3%. Uncalibrated, continuously variable between steps and to approx 50 V/div.

INPUT RC

1 megohm paralleled by approx 47 pF.

MAXIMUM INPUT VOLTAGE

600 V combined DC + peak AC.

OPERATING MODES

Includes Channel 1 only (normal or inverted); Channel 2 only; Alternate—Channel 1 and 2 switched electronically on alternate sweeps; Chopped—successive 16- μ s segments of each channel are displayed at an approx 30-kHz rate per channel. Chopped transient blanking is provided; Added—outputs of Channel 1 and 2 algebraically added.

MULTIPLE X-Y DISPLAYS

Obtained with two Type 3A72 Plug-In Units; both synchronization and automatic pairing are provided. With two Type 3A72's operated in the dual-trace mode, Channel 1 of the left-hand unit is always plotted against Channel 1 of the right-hand unit.



WEIGHTS

Net weight	5 lb	2.3 kg
Domestic shipping weight	≈ 8 lb	≈ 3.6 kg
Export-packed weight	≈ 13 lb	≈ 5.9 kg

INCLUDED STANDARD ACCESSORIES

Two instruction manuals (070-0274-00).

OPTIONAL ACCESSORIES

The probes recommended for use with this instrument satisfy most measurement requirements. Additional probes are available that may be better suited for a particular application, including high-voltage and current measurements. See catalog accessory pages for information on these and other items.

P6028 1X Probe Package, order 010-0074-00

P6006 10X Probe Package, order 010-0127-00

P6007 100X Probe Package, order 010-0150-00

Please refer to Terms and Shipment, General Information page.

DC-to-2 MHz FOUR-TRACE AMPLIFIER UNIT

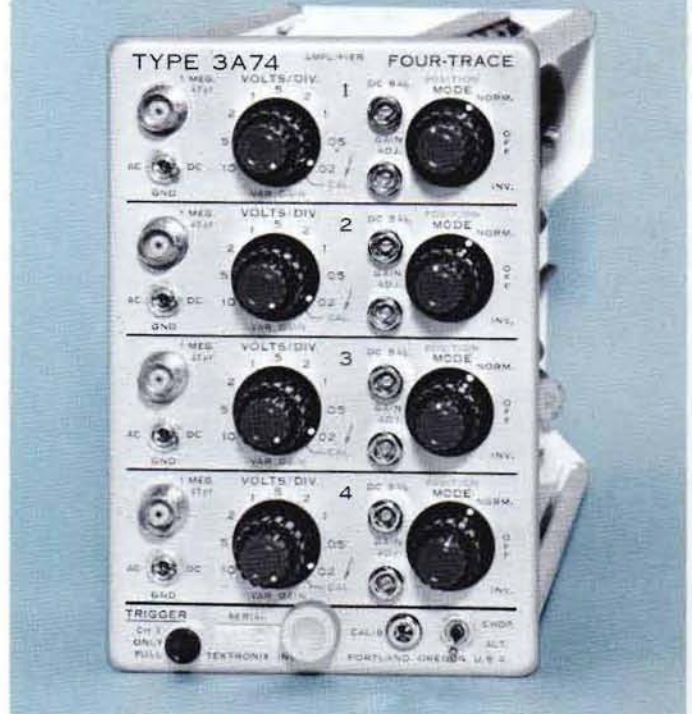

- **FOUR SEPARATE CHANNELS**
- **20 mV/DIV TO 10 V/DIV CALIBRATED DEFLECTION FACTOR**

The Type 3A74 Amplifier is a general-purpose multi-trace plug-in unit that has four separate channels, each with identical characteristics. The unit can operate in a number of modes for a variety of single and multi-trace displays. The Type 3A74 can be used in the Type 561A, Type 564, Type 565, and in the Type 567/6R1A or Type 568/230 Oscilloscope. However, in the Type 567/6R1A or Type 568/230, the measurements will not be presented in digital form.

BANDWIDTH

DC to 2 MHz at 3-dB down. AC-coupled low-frequency response is 2 Hz, 0.2 Hz with 10X probe.

RISETIME

Approximately 0.17 μ s.

DEFLECTION FACTOR

0.02 V/div to 10 V/div in 9 calibrated steps, 1-2-5 sequence; accurate within 3%. Uncalibrated, continuously variable between steps and to approx 25 V/div.

INPUT RC

1 megohm paralleled by approx 47 pF.

MAXIMUM INPUT VOLTAGE

600 V combined DC + peak AC.

OPERATING MODES

Includes any one of the four channels separately (normal or inverted); Alternate—any combination of two or more channels switched electronically on alternate sweeps; Chopped — successive 2- μ s segments of each channel are displayed at an approx rate per channel of: 250 kHz when using two channels; 167 kHz when using three channels; and 125 kHz when using four channels. Chopped transient blanking is provided.

MULTIPLE X-Y DISPLAYS

Obtained by using two Type 3A74 Plug-In Units; both synchronization and automatic pairing are provided. With two Type 3A74's, two, three or four independent displays may be obtained, properly paired: Channel 4 of the left-hand unit is always plotted against Channel 4 of the right-hand unit, Channel 3 versus Channel 3, etc.

INTERNAL TRIGGER SIGNAL (for the time-base)

From one of two sources as selected; either from the output of Channel 1 only or the combined output of the amplifier.

WEIGHTS

Net weight	6 $\frac{1}{4}$ lb	2.8 kg
Domestic shipping weight	\approx 10 lb	\approx 4.5 kg
Export-packed weight	\approx 14 lb	\approx 6.4 kg

INCLUDED STANDARD ACCESSORIES

Four BNC to binding-post adapters (103-0033-00); two instruction manuals (070-0347-01).

OPTIONAL ACCESSORIES

The probes recommended for use with this instrument satisfy most measurement requirements. Additional probes are available that may be better suited for a particular application, including high-voltage and current measurements. See catalog accessory pages for information on these and other items.

P6028 1X Probe Package, order 010-0074-00

P6006 10X Probe Package 010-0127-00

P6007 100X Probe Package, order 010-0150-00

Please refer to Terms and Shipment, General Information page.

TYPE 3A75

DC-to-4 MHz AMPLIFIER UNIT

- DC-TO-4-MHz BANDWIDTH
- 50 mV/DIV TO 20 V/DIV CALIBRATED DEFLECTION FACTOR

The Type 3A75 Amplifier is a general-purpose wide-band plug-in unit. It may be used in the Type 561A, Type 564, Type 565, or in the Type 567/6R1A and Type 568/230 Oscilloscope without digital readout. Used with the Type 129 Power Supply, the Type 3A75 can drive recorders, X-Y plotters, oscilloscopes and other indicators.

BANDWIDTH

DC to 4 MHz at 3-dB down. AC-coupled low-frequency response is 2 Hz, 0.2 Hz with 10X probe.

RISETIME

Approximately 90 ns.

DEFLECTION FACTOR

50 mV/div to 20 V/div in 9 calibrated steps, 1-2-5 sequence; accurate within 3%. Uncalibrated, continuously variable between steps and to approx 50 V/div.

INPUT RC

1 megohm paralleled by approx 47 pF.

MAXIMUM INPUT VOLTAGE

600 V combined DC + peak AC.

WEIGHTS

Net weight	3½ lb	1.6 kg
Domestic shipping weight	≈ 6 lb	≈ 2.7 kg
Export-packed weight	≈ 11 lb	≈ 5.0 kg

INCLUDED STANDARD ACCESSORIES

Two instruction manuals (070-0275-00).

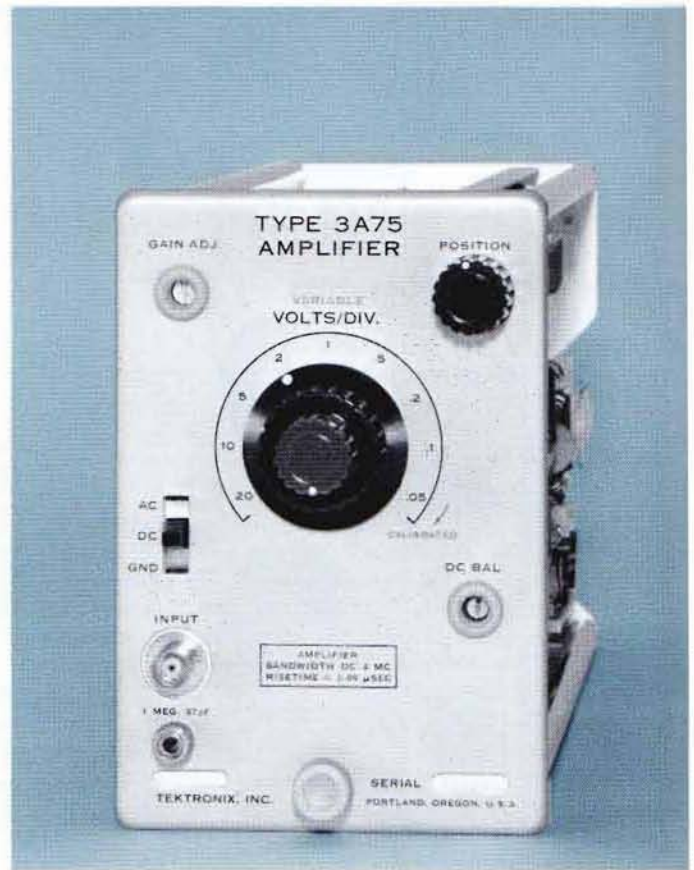

OPTIONAL ACCESSORIES

The probes recommended for use with this instrument satisfy most measurement requirements. Additional probes are available that may be better suited for a particular application, including high-voltage and current measurements. See catalog accessory pages for information on these and other items.

P6028 1X Probe Package, order 010-0074-00

P6006 10X Probe Package, order 010-0127-00

P6007 100X Probe Package, order 010-0150-00

Please refer to Terms and Shipment, General Information page.

TIME-BASE UNIT

- 500 ns/DIV TO 1 s/DIV CALIBRATED TIME BASE
- CALIBRATED SWEEP DELAY
- TRIGGERING TO 10 MHz
- SINGLE SWEEP OPERATION

The Type 3B3 Time-Base Unit is used to generate normal and delayed sweeps. Flexible triggering facilities are similar for both the normal sweep and delayed sweep. Calibrated sweep delay enables accurate delay intervals to be set and measured. The unit can be used with the Type 561A or Type 564, and with the Type 567/6R1A or Type 568/230 Oscilloscope without digital readout.

TIME BASE

(Both normal and delayed sweeps.) 0.5 μ s/div to 1 s/div in 20 calibrated steps, 1-2-5 sequence; accurate within 3%. Uncalibrated, continuously variable between steps and to approx 2.5 s/div. The Variable control operates with the normal sweep in the normal display mode, and with delayed sweep in all other display modes.

5X MAGNIFIER

Expands the fastest sweep rate to 0.1 μ s/div. Magnified sweep accurate within 5%.

SINGLE SWEEP

Facilitates photographic recordings of waveforms.

CALIBRATED SWEEP DELAY

Permits accurate setting and measuring of delay intervals from 0.5 μ s to 10 s, continuously variable in 20 ranges. One control can select both the normal and delayed sweeps simultaneously or the delayed sweep rate can be selected independent of the normal sweep. Delay accurate within 1% of full scale reading and delay time linearity is within 0.2% of full scale from 5 μ s to 2 s of delay.

The normal sweep generator operates as the display time base in (1) the NORMAL position, (2) the INTENSIFIED position—where the delayed-sweep generator intensifies a portion of the normal sweep trace, indicating the time during which the delayed sweep operates—and (3) the TRIGGERED, INTENSIFIED position—where the delayed sweep is armed at the end of the delay time and starts by the delayed sweep trigger . . . intensifying a segment of the normal sweep trace as above.

The delayed-sweep generator operates as the display time base in (1) the DELAYED SWEEP position—displaying the portion of the trace which was intensified in the INTENSIFIED position . . . with time-jitter less than 1 part in 20,000 of the maximum available delay interval—and (2) the jitter-free TRIGGERED, DELAYED SWEEP position—displaying the portion of the trace which was intensified in the TRIGGERED, INTENSIFIED position.

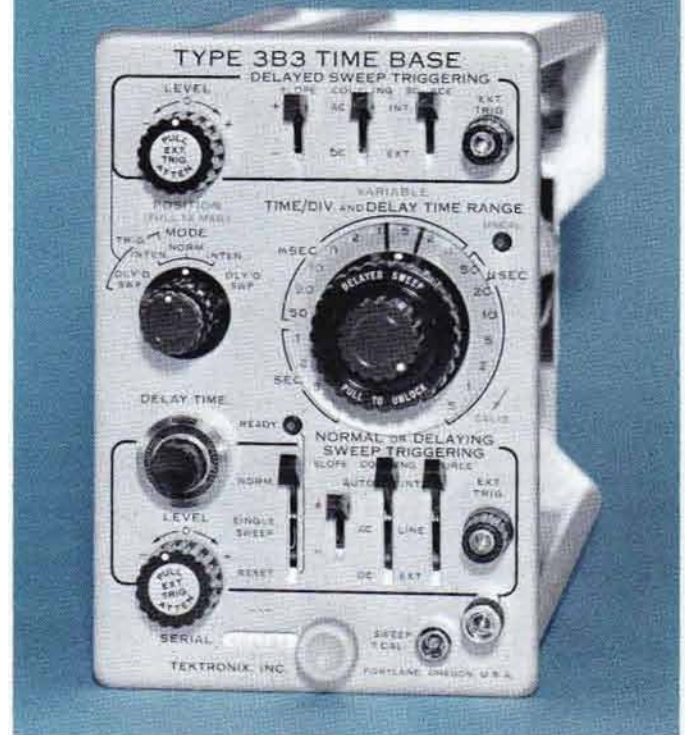

MODES

Normal-Sweep Trigger—manual or automatic.
Delayed-Sweep Trigger—manual only.

COUPLING

AC or DC.

SOURCES

Internal or External. Line triggering in normal or delaying sweep operation only. External trigger facility has two ranges: 0.5 to 15 V and 5 to 150 V, plus or minus polarity.

REQUIREMENTS

Internal Triggering—0.4 major graticule divisions from DC to 5 MHz, increasing to 1 major division at 10 MHz.
External Triggering—0.5 V from DC to 5 MHz, increasing to 1.25 V at 10 MHz. Requirements increase below 6 Hz with AC-coupling.

WEIGHTS

Net weight	5 $\frac{1}{4}$ lb	2.3 kg
Domestic shipping weight	≈ 9 lb	≈ 4.1 kg
Export-packed weight	≈ 13 lb	≈ 5.9 kg

INCLUDED STANDARD ACCESSORIES

Two instruction manuals (070-0365-01).

Please refer to Terms and Shipment, General Information page.

TYPE 3B4

TIME-BASE UNIT

- 50 ns/DIV TO 5 s/DIV CALIBRATED TIME BASE
- TRIGGERING TO 20 MHz
- DIRECT READING MAGNIFIER
- CALIBRATED EXTERNAL HORIZONTAL INPUT
- SINGLE SWEEP OPERATION

The Type 3B4 Plug-In Unit is a wide-range time base with flexible, high-speed triggering facilities, and a wide-range, direct-reading magnifier. It can be used in the Type 561A or Type 564, and in the Type 567/6R1A or Type 568/230 Oscilloscope without digital readout. The Type 3B4 is recommended for operation with Types 3A1, 3A6 and other wideband (≥ 2 MHz) vertical amplifier plug-in units.

In addition to time base facilities, the 3B4 provides a DC-coupled external input amplifier with calibrated deflection factors from 0.2 to 5 V/div.

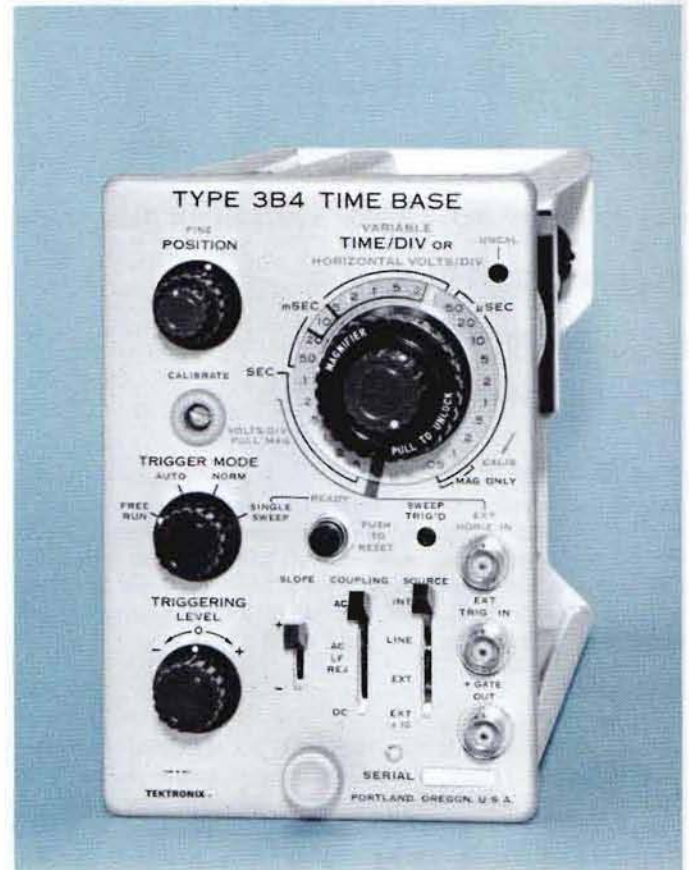

TRIGGER

TIME BASE

0.2 μ s/div to 5 s/div in 23 calibrated steps, 1-2-5 sequence; accuracy within 3% from 0.2 μ s/div to 2 s/div, within 5% at 5 s/div. Uncalibrated, continuously variable between steps and to 12.5 s/div.

DIRECT READING MAGNIFIER

Provides sweep expansion up to X50 and extends the fastest sweep rate to 50 ns/div. The MAGNIFIER control is concentric with the TIME/DIV control, providing a direct indication of both the sweep rate being magnified and the magnified time/div rate. Up to 5 magnification steps are provided, to X40, or X50, depending on the TIME/DIV control setting before magnification. Magnified sweep rates are confined to the time/div steps on the panel, so there are no "forbidden" (uncalibrated) combinations. Magnified sweep accurate within 5%.

The MAGNIFIER control is also used to set the external input deflection factor when the TIME/DIV control is in the "Ext Input" position.

EXTERNAL HORIZONTAL INPUT

0.2 V/div to 5 V/div in 5 calibrated steps (max input ± 20 V); accuracy, when plug-in unit is matched to oscilloscope, is within 3%. The External Input Amplifier is DC-coupled.

SINGLE SWEEP

Facilitates waveform photography and operation in the Type 561A or 564 Oscilloscope.

MODES

Manual, free-run, automatic (with bright base-line in the absence of a trigger).

COUPLING

AC, AC LF-Reject, DC.

SOURCES

Internal, Line, External, External $\div 10$. A front panel light indicates when the sweep is receiving a triggering signal—especially convenient when using an external trigger.

REQUIREMENTS

Internal Triggering—1 minor graticule division from DC to 20 MHz, with additional deflection required above 20 MHz. External Triggering—0.5 V to 15 V (EXT) or 5 V to 150 V (EXT $\div 10$) from DC to 20 MHz, with additional signal required above 20 MHz. Requirements increase below 30 Hz with AC-coupling.

WEIGHTS

Net weight	4½ lb	2 kg
Domestic shipping weight	≈ 7 lb	≈ 3.2 kg
Export-packed weight	≈ 13 lb	≈ 5.9 kg

INCLUDED STANDARD ACCESSORIES

Two instruction manuals (070-0431-00).

Please refer to Terms and Shipment, General Information page.

TYPE 3C66

CARRIER AMPLIFIER UNIT

- **HIGH GAIN**
- **LOW NOISE**
- **ESSENTIALLY DRIFT FREE**
- **RECORDER OUTPUT**

The Type 3C66 Carrier Amplifier with suitable transducer measures mechanical quantities that can be converted to a change in resistance, capacitance, or inductance. This unit may be used in the Type 561A, Type 564, Type 565, or in the Types 567/6R1A and 568/230 Oscilloscopes without digital readout. Used with the Type 129 Power Supply, the Type 3C66 can drive recorders, X-Y plotters, oscilloscopes, and other indicators.

The gap between mechanical engineering and electronic instrumentation is bridged with the Type 3C66 and suitable transducers. The total range of applications is as broad as the mechanical field itself and includes stress analysis, vibration studies, and fatigue tests. Typical quantities measured are force, displacement, acceleration, and strain.

The Type 3C66 operates on an AC carrier principle. It uses an AC bridge at the input to convert transducer signals into an amplitude-modulated carrier signal. The carrier signal is amplified by a high-gain AC amplifier and then demodulated to obtain the CRT deflection voltages.

Advantages of the 3C66 Carrier Amplifier include:

1. Desirable high gain with essentially no drift resulting from input signal conversion to carrier modulation followed by AC amplification.
2. Both static and dynamic strain are measured because of the DC to 5-kHz bandwidth.
3. Most of the undesired pickup from the input is eliminated because of selective filtering.
4. Reactive transducers (including some differential transformers) as well as capacitive and resistive transducers can be used with the unit.
5. Up to four simultaneous signals to the input bridge are possible.



BANDWIDTH

DC to 5 kHz at 3-dB down.

RISETIME

Approximately 70 μ s.

CALIBRATED DEFLECTION FACTOR

10 microstrain/div (micro-inches per inch/div) to 10,000 microstrain/div when the Type 3C66 is used with a single strain gage having a gage factor of approximately 2. Uncalibrated continuous control from 10 microstrain/div to 25,000 microstrain/div. Attenuator accuracy, when set accurately in any one step, is within 2% on all other steps.

AMPLIFIER INPUT

Input is to an AC bridge with 25-kHz excitation voltage. One or more of the four bridge arms can have transducers attached to them. Total bridge voltage is approximately 5 V RMS, regulated.

NOISE

Typically equivalent to an input of 2.0 microstrain (peak to peak) at maximum calibrated sensitivity. This approximates an RMS noise of 0.5 microstrain.

DRIFT

Drift of the over-all system is primarily a function of the transducer stability. The Type 3C66 Amplifier system is essentially drift free.

GAGE FACTORS

Factors from 1 to 6 are usable without changing the steps of the sensitivity control. The range of factors is compensated for by adjusting the Gain Adjust Control.

EQUIVALENT DC SENSITIVITY

A comparable DC amplification system would require approximately 10 microvolts/div sensitivity for the same amount of power applied to the Type 3C66.

TYPE 3C66

CAPACITIVE TRANSDUCERS

Used in conjunction with a four-arm resistive bridge results in the following maximum useful sensitivities: 120-ohm bridge, 1 pF/div; 1000-ohm bridge, 0.2 pF/div; useful sensitivities are slightly lower when using long cables.

INDUCTIVE TRANSDUCERS

Must have characteristics compatible with the 25-kHz carrier frequency to function properly. Linear-variable-differential transformers designed for nominal carrier frequencies of 2 kHz and higher usually operate satisfactorily without additional circuitry.

TRANSDUCER CABLE

Either 3-wire or 4-wire shielded microphone cable gives the best results in most applications.

CAPACITANCE BRIDGE BALANCE

A vernier control allows compensation for an unbalance of up to 250 pF across any external resistive arm of the input bridge.

RESISTIVE BRIDGE BALANCE

A vernier control provides sufficient range to compensate for most standard transducers and strain gages.

GAGE RESISTANCE RANGE

Useful with cable lengths to 100 feet; and extends from approximately 50 ohms to 2000 ohms.

PHASE ADJUSTMENT

Permits either resistive or reactive transducer applications to be displayed (thus making the Type 3C66 very versatile).

CALIBRATION SWITCH

A rotary switch connects a calibration resistor across the strain gage electrically to simulate an external mechanical strain. The calibration resistor supplied with the Type 3C66 unit simulates a —400 microstrain unbalance of the bridge and is suitable for most strain gage applications. The calibration resistor is mounted on a handy plug-in receptacle. No special gage dial is necessary for the unit.

To aid in calibration, a nomograph is included in the instruction manual. This nomograph relates calibration of the supplied resistor to gage factors and strain gage resistances.

To include the gage factor in the calibration, merely increase or decrease the amplifier gain proportionally.

SYNC IN AND OUT CONNECTORS

Used for synchronizing oscillators of two units thus eliminating low frequency beat notes which sometimes occur when two units are used in the same indicator at high sensitivities.

RECORDER SIGNAL OUTPUT

DC coupled with an output of about 3 V for each major division of CRT display. DC level is adjustable to 0 V by an internal control.

WEIGHTS

Net weight	5 lb	2.3 kg
Domestic shipping weight	≈ 9 lb	≈ 4.1 kg
Export-packed weight	≈ 14 lb	≈ 6.4 kg

INCLUDED STANDARD ACCESSORIES

Synchronizing cable, RG174/U (012-0063-00); 4-wire 15 ft shielded connector cable (012-0040-00); two instruction manuals (070-0357-00).

Please refer to Terms and Shipment, General Information page.

TYPE 3C66 CARRIER AMPLIFIER BLOCK DIAGRAM

The input circuit for the unit is an AC bridge that has an external transducer connected into one or more of the bridge arms. Excitation voltage for the bridge is obtained from the 25-kHz oscillator.

In operation, the transducer signals unbalance the bridge to modulate the 25-kHz signal to produce an amplitude modulated suppressed-carrier output. The amplitude of the signal from the bridge is determined by amount of unbalance produced by the transducer signal. With no signal from the transducer, the carrier is suppressed. The phase of the bridge output is determined by the direction and type of unbalance.

The suppressed-carrier output of the bridge circuit is applied to the AC amplifier where the desired modulation sidebands are amplified while unwanted frequencies are rejected. An attenuator and gain control located in the amplifier determine the over-all sensitivity of the unit.

The amplified modulation sidebands are applied to the phase-sensitive demodulator where a carrier is added in proper phase. The carrier permits only the desired phase to be demodulated.

The output of the demodulator circuit is applied to a filter network where the undesirable modulation components are eliminated. The output from the filter is then applied to the associated oscilloscope through the interconnecting plug. The signal applied to the oscilloscope corresponds exactly to the signal applied to the input bridge circuit by the external transducer.

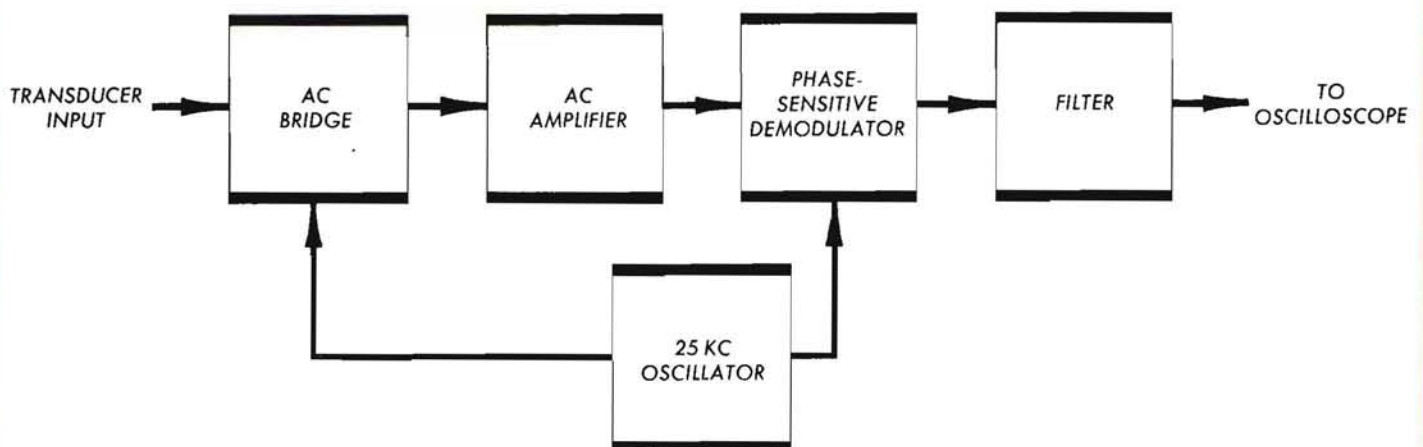

50 Hz-to-1 MHz SPECTRUM ANALYZER UNIT

- CALIBRATED VERTICAL DEFLECTION
- CALIBRATED DISPERSION
- 10 Hz TO 1 MHz IN ONE DISPLAY
- TIME-BASED OR FREQUENCY-BASED DISPLAYS
- REPETITIVE OR MANUAL SCAN
- RECORDER OUTPUT
- SOLID-STATE DESIGN



The Type 3L5 operates over a center-frequency range of 50 Hz to 1 MHz, and provides accurate spectral and time-based displays from 10 Hz to 1 MHz. Calibrated volts/div and Hz/div controls make the Type 3L5 as easy to use as the Type 561A or 564 Oscilloscope in which it operates. The Type 3L5 can be used with a Type 2B67, 3B3, 3B4, or 3B5 Time Base Unit.* Used with Type 129 Power Supply, the Type 3L5 can drive recording equipment, X-Y plotters, oscilloscopes or other indicators.

Resolution bandwidth extends from 10 Hz to 500 Hz. High-resolution spectral displays can be viewed in their entirety (even at the very slow sweep rates required for maximum resolution) with the Type 564 Storage Oscilloscope. Stored displays can also be compared with subsequent displays, and can be easily photographed for permanent record.

Applications include vibration studies, waveform analysis, and noise measurements.

*IMPORTANT: Time Base Units with serial numbers under those listed require a simple modification to provide a sweep signal to the Analyzer. Type 2B67: 15180, Type 3B3: 4270, Type 3B4: 740. Modification Kit part number 040-0413-00.

SPECTRAL DISPLAYS

CENTER FREQUENCY RANGE

50-Hz to 990-kHz, selectable in 10-Hz, 100-Hz, 1-kHz and 10-kHz steps. Continuously variable to at least 1 MHz.

CENTER FREQUENCY	ACCURACY
50 Hz to 990 Hz	$\pm(5\% + 50 \text{ Hz} + 50 \text{ Hz}/^\circ\text{C change})$
1000 Hz to 9900 Hz	$\pm(5\% + 100 \text{ Hz} + 100 \text{ Hz}/^\circ\text{C change})$
10 kHz to 99 kHz	$\pm(5\% + 3 \text{ kHz} + 200 \text{ Hz}/^\circ\text{C change})$
100 kHz to 990 kHz	$\pm(5\% + 10 \text{ kHz} + 200 \text{ Hz}/^\circ\text{C change})$

DEFLECTION FACTOR

10 $\mu\text{V}/\text{div}$ to 2 V/div in calibrated RMS steps (1-2-5 sequence) accurate within 3%, decreasing to 6% when V/DIV \div 100 is pulled. Variable control provides continuous, uncalibrated variation between steps, reduces gain by a factor of approx 3.

CALIBRATED DISPERSION

10 Hz/div to 100 kHz/div in 9 steps. Accuracy at center frequencies of 50 Hz to 9900 Hz within 10% at $25^\circ \pm 5^\circ\text{C}$, within 20% at $25^\circ \pm 25^\circ\text{C}$; accuracy at center frequencies of 10 kHz to 990 kHz within 10% at $25^\circ \pm 25^\circ\text{C}$. Linearity within 3%.

COUPLED RESOLUTION

$\leq 10 \text{ Hz}$ to $\geq 500 \text{ Hz}$, coupled with calibrated dispersion positions and separately switchable.

DISPLAY FLATNESS

$\pm 0.5 \text{ dB}$ from 10 Hz to 1 MHz, most deflection factors; $+0.5 \text{ dB}$, -3 dB at 1 mV/div and 2 mV/div (or 10 $\mu\text{V}/\text{div}$ and 20 $\mu\text{V}/\text{div}$ with $\div 100$ switch pulled).

NOISE

$\leq 5 \mu\text{V RMS}$.

INCIDENTAL FM

$\leq 3 \text{ Hz}$ from 50 Hz to 9900 Hz; $\leq 10 \text{ Hz}$ from 9900 Hz to 990 kHz.

DYNAMIC RANGE

$\geq 60 \text{ dB}$ in LOG (uncalibrated) mode.

TYPE 3L5

INTERMODULATION DISTORTION

>50-dB below reference signals.

RECORDER OUTPUT

5 to 15 mV for 8 div display, 600- Ω source resistance, DC coupled.

LOCAL OSCILLATOR OUTPUT

Must sweep ≥ 1 MHz from ≈ 3 MHz to ≈ 2 MHz; ≥ 1 V peak to peak.

SWEEP MODES

Manual and internal. Accuracy of frequency measurements can be increased using manual scan and monitoring the local oscillator output with a frequency counter. Type 561A and 564 Oscilloscopes with time base units provide an internally-coupled sweep to the Analyzer.

TIME-BASED DISPLAYS

BANDWIDTH

10 Hz to 1 MHz at most deflection factors; 10 Hz to 700 kHz at 0.1 V/div and 0.2 V/div (or 1 mV/div and 2 mV/div with $\div 100$ switch pulled).

DEFLECTION FACTOR

1 mV/div to 100 V/div in calibrated P to P steps (1-2-5 sequence), accurate within 3% (within 6% from 5 V/div to 100 V/div). Uncalibrated control provides continuous variation between steps, reduces gain by a factor of approx 3.

INPUT RC

1 megohm paralleled by approx 30 pF.

OTHER CHARACTERISTICS

WEIGHTS

Net weight	5 $\frac{3}{4}$ lb	2.6 kg
Domestic shipping weight	≈ 8 lb	≈ 3.6 kg
Export-packed weight	≈ 12 lb	≈ 5.5 kg

INCLUDED STANDARD ACCESSORIES

1X probe (010-0193-00); banana-to-banana cable (012-0031-00); BNC-to-banana cable (012-0091-00); plug (134-0052-00); plug protector (134-0076-00); two instruction manuals (070-0630-00).

OPTIONAL ACCESSORIES

The standard 1X probe supplied with the analyzer satisfies most measurement requirements. Optional probes may be better suited for particular applications. See catalog accessory pages for additional information on these and other items.

P6007 100X Probe Package, order 010-0150-00

P6012 10X Probe Package, order 010-0203-00

600- Ω Termination (BNC), order 011-0092-00

Please refer to Terms and Shipment, General Information page.

1-to-36 MHz SPECTRUM ANALYZER UNIT

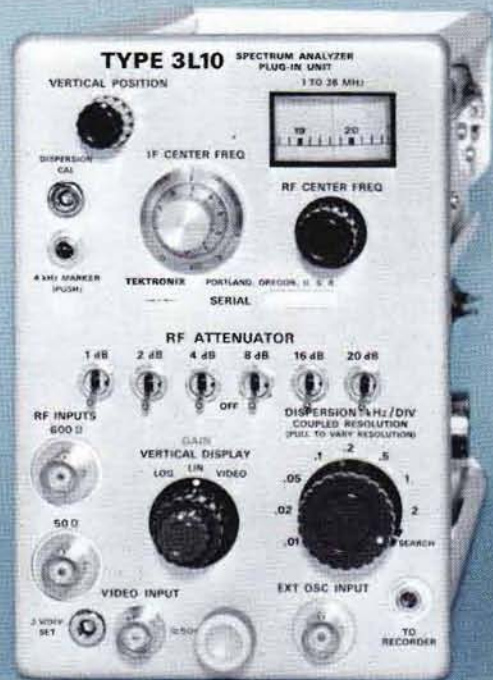

- **CALIBRATED DISPERSION**
- **COUPLED RESOLUTION**
- **CRYSTAL-CONTROLLED SWEEP OSCILLATOR**
- **IMAGE REJECTION**
- **RECORDER OUTPUT**
- **STORED SPECTRAL DISPLAYS**

This 1-to-36 MHz Analyzer permits low-cost spectrum analysis with the compact Type 561A Oscilloscope, and stored or non-stored displays with the equally-compact Type 564 Oscilloscope. The Type 3L10 can be used with a Type 2B67, 3B3, 3B4 or 3B5 Time Base Unit.*

CALIBRATED DISPERSION from 10 Hz/div to 2 kHz/div makes frequency measurement as easy and accurate as time measurement. Frequency differences can be read directly from the CRT. The **SEARCH MODE** permits rapid location of signals for analysis.

COUPLED RESOLUTION from 10 Hz to 1 kHz greatly simplifies operation, providing narrow resolution bandwidth at narrow dispersion and wide resolution bandwidth at wide dispersion. Dispersion and resolution controls can be uncoupled and operated separately if desired, for optimized viewing of a particular signal.

IF stability is achieved through use of **CRYSTAL-CONTROLLED OSCILLATORS**. Even the swept local oscillator is controlled through a crystal discriminator. An external front-end oscillator can be connected through a front-panel input to provide still greater stability to spectral displays within or outside the normal 1-to-36 MHz range of the Type 3L10.

IMAGE REJECTION is achieved through use of a 60-MHz first IF amplifier, which places images at more than twice the upper tuning frequency of the Type 3L10.

Analyzer familiarity is soon achieved, since operation is similar to that of the oscilloscope—with dispersion calibrated in kHz/div. Dispersion accuracy is quickly verified with crystal-controlled frequency markers available at the push of a button. This feature is especially convenient where the Analyzer is used with more than one oscilloscope.

*IMPORTANT: Time Base Units with serial numbers under those listed require a simple modification to provide a sweep signal to the Analyzer. Type 2B67: 15180, Type 3B3: 4270, Type 3B4: 740. Modification Kit part number 040-0413-00.

FREQUENCY RANGE

1 to 36 MHz.

MINIMUM CW SENSITIVITY (50-Ω INPUT)

−100 dBm, measured at 2 kHz/div dispersion and 1 kHz (coupled) resolution.

DIAL ACCURACY

±(100 kHz + 1% of dial reading).

CALIBRATED DISPERSION

10 Hz/div to 2 kHz/div, 8 steps, 1-2-5 sequence. Accuracy within ±3% when calibrated with internal calibrator. Dispersion linearity within ±5%. Search position (uncalibrated) — minimum 20 kHz + 1 kHz/MHz of indicated frequency full scale (10 div).

DISPERSION CALIBRATOR

10.7-MHz carrier, 4-kHz crystal-controlled side-bands with ±0.1% accuracy.

COUPLED RESOLUTION

10 Hz to 1 kHz, coupled with calibrated dispersion positions, and separately switchable. Search position—approximately 10 kHz.

DISPLAY FLATNESS

±1 dB.

MAXIMUM INCIDENTAL FM

IF within 5 Hz.

LO within 25 Hz + 1 Hz/MHz dial frequency.

FREQUENCY STABILITY

IF within 2 p/m per °F change, 1 p/m per 1-V line change.

LO within 150 p/m per °F change, 10 p/m per 1-V line change.

TYPE 3L10

INPUT IMPEDANCE

Approx 50 Ω and approx 600 Ω .

MAXIMUM INPUT POWER

+24 dBm at full RF attenuation, -20 dBm without RF attenuation.

RF ATTENUATOR

51 dB \pm 0.1 dB/dB in 1-dB steps.

1/2 watt maximum power-handling capability.

IF GAIN CONTROL

>60-dB range.

VERTICAL DISPLAY (8 DIVISIONS)

Log—50-dB dynamic range.

Linear—20-dB dynamic range.

Video—100 mV/div (variable) DC to 50 kHz, approx 50- Ω input resistance.

RECORDER OUTPUT

DC-coupled, approx 600- Ω source resistance, 15 mV/div display in Linear mode, output linear with voltage.

WEIGHTS

Net weight	6 $\frac{1}{4}$ lb	2.8 kg
Domestic shipping weight	\approx 10 lb	\approx 4.5 kg
Export-packed weight	\approx 17 lb	\approx 7.7 kg

INCLUDED STANDARD ACCESSORIES

Tini-plug (134-0052-00); two instruction manuals (070-0521-00).

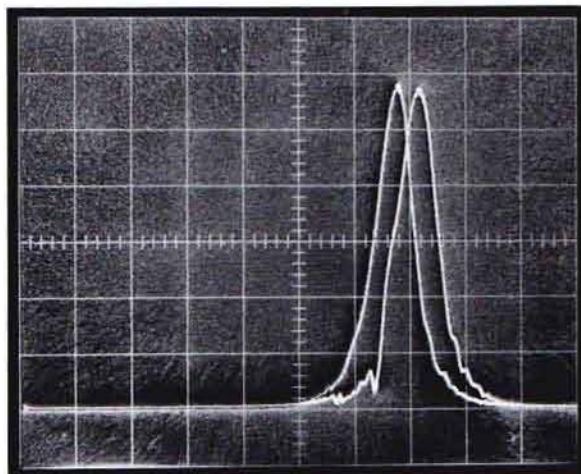

STORED SPECTRAL DISPLAY with Type 564 Oscilloscope

Using the single-shot capabilities of the Type 2B67, and the storage capabilities of the Type 564, we are able to measure the drift of a 60-MHz crystal oscillator, as supplied to the IF of the Type 3L10.

Temperature variation shows as a drift of approx 4 Hz between sweeps. Dispersion is 10 Hz/div.

Please refer to Terms and Shipment, General Information page.

NEW

- **DC-to-1 GHz BANDWIDTH**
- **INTERNAL TRIGGERING AND DELAY LINES**
- **2 mV/DIV to 200 mV/DIV DEFLECTION FACTOR**
- **RANDOM NOISE LESS THAN 2 mV (UNSMOOTHED)**

The Type 3S1 Plug-In Amplifier is a dual-trace sampling unit designed for use in the Type 561A, 564, 567 or Type 568 Oscilloscope. The unit can be used with sampling sweep units, or with real-time time base units allowing sweep rates from 20 ps/div to 5 s/div.

The Type 3S1 features fast-rise, low-noise performance coupled with excellent transient response. The unit has two identical channels, each with internal trigger takeoff and a signal delay line. It can be operated in any of five modes for a variety of single, dual-trace, or X-Y displays. A DC-Offset provision allows the display of signals with DC voltages up to ± 1 volt. Power is provided at the front panel for use with probes and other accessories.

CHARACTERISTICS

RISETIME

Less than or equal to 350 ps.

BANDWIDTH

Equivalent to DC to 1 GHz at 3-dB down.

TRANSIENT RESPONSE

$\pm 2\%$ or less aberrations in the first 5 ns following the step transition, $\pm 1\%$ or less after 5 ns (as observed with a Tektronix Type 281 TDR Pulser).

DEFLECTION FACTOR

2 mV/div to 200 mV/div in 7 calibrated steps, 1-2-5 sequence. Each step accurate within 3%. Variable between steps, extending to 0.8 mV/div, uncalibrated.

RANDOM NOISE

Equivalent to an input signal of 2 mV or less unsmoothed, or 1 mV smoothed (tangentially measured).

INPUT CHARACTERISTICS

Nominally 50 ohms. Safe overload is ± 5 V. GR 874 input connectors.

DC OFFSET RANGE

+1 V to -1 V. Allows signals between +1 V and -1 V limits to be displayed at 2 mV/div. Signals between +2 V and -2 V limits may be displayed at 200 mV/div. Monitor jacks provide 10X actual DC offset through 10 k Ω .

TRIGGERING

Separate internal delay lines and trigger pickoffs permit triggering on either input signal. Trigger pickoffs deliver to the timing unit approximately 10% of the input signal amplitude.

DISPLAY MODES

A only, B only, Dual-Trace, Algebraic Addition of A and B signals, and X-Y display of A-vertically and B-horizontally (for observation of hysteresis loops, phase shift and similar displays). Independent controls for each channel permit positioning and inverting displays as desired. Time coincidence between channels is within 30 ps.

350-ps DUAL-TRACE SAMPLING UNIT



VERTICAL OUTPUT

200 mV for each division of displayed signal through 10 k Ω . Zero volt level corresponds to center of screen.

PROBE POWER

Available at front-panel connectors for accessories such as P6032 Cathode-Follower Probes, Type 281 TDR Pulser, and Type 282 Adapters for high-impedance probes.

WEIGHTS

Net weight	7 ³ / ₄ lb	3.5 kg
Domestic shipping weight	$\approx 10\frac{1}{2}$ lb	≈ 4.8 kg
Export-packed weight	$\approx 14\frac{1}{2}$ lb	≈ 6.6 kg

INCLUDED STANDARD ACCESSORIES

Two 5-ns 50- Ω RG58 cables, GR connectors (017-0512-00); two 10X 50- Ω attenuators, GR connectors (017-0078-00); two instruction manuals (070-0632-00).

OPTIONAL ACCESSORIES

- Type 281 TDR Pulser, order 015-0060-00
- Type 282 Probe Adapter, order 015-0074-00
- P6040/CT-1 Current Probe, order 015-0041-00
- CT-3 Signal Pickoff, order 017-0061-00
- VP-1 Voltage Pickoff, order 017-0073-00
- P6034 10X Passive Probe, order 010-0110-00
- P6035 100X Passive Probe, order 010-0111-00
- Power Divider GR 874-TPD, order 017-0082-00
- Coupling Capacitor, GR 874-K, order 017-0028-00

Please refer to Terms and Shipment, General Information page.

TYPE 3S2

DUAL-TRACE SAMPLING UNIT

● PLUG-IN SAMPLING HEADS

Type S1, 350-ps risetime, low noise

Type S2, 50-ps risetime

● 2 mV/DIV TO 200 mV/DIV DEFLECTION FACTOR

● VARIABLE INTER-CHANNEL DELAY

● NEW PERFORMANCE WITH RANDOM SAMPLING

The Type 3S2 Dual-Trace Sampling Unit is designed for use in the Type 561A, 564, 567 or 568 Oscilloscope. The unit can be used with sampling sweep units, including the Type 3T2 Random Sampling Sweep, or with real-time time base units to allow sweep rates to 5 s/div.

The Type 3S2 accepts two sampling heads that can be inserted directly or located remotely with an optional extender.

Plug-In sampling heads (choice of fast-risetime or low-noise) are available for applications requiring two identical channels, or a combination of fast-risetime and low-noise channels. A front-panel control allows adjustment of the inter-channel time relationship to compensate for signal cables or other external delays. Five display modes provide for a variety of single-trace, dual-trace or X-Y displays. The 3S2 can also be operated with only one head, for applications not presently requiring dual-trace displays.

CHARACTERISTICS

SAMPLING HEADS

Accepts Type S1 or S2 Sampling Heads. (See next page for characteristics).

DEFLECTION FACTOR

2 mV/div to 200 mV/div in 7 calibrated steps, 1-2-5 sequence. Each step accurate within 3%. Variable between steps, extending to approximately 0.8 mV/cm, uncalibrated.

DC OFFSET RANGE

+1 V to -1 V. Allows signals between 1 V and -1 V limits to be displayed at 2 mV/div. Signals between +2 V and -2 V limits can be displayed at 200 mV/div. Monitor jacks provide 10X actual DC offset through 10 k Ω .

TRIGGERING

Trigger pickoff within sampling heads permits triggering on either input signal. 50- Ω Trigger Out connector at the front panel delivers approximately 10% of the input signal amplitude to the 50- Ω External Trigger Input of the sweep unit.

B-DELAY RANGE

Channel B display can be continuously positioned in time from +5 ns to -5 ns with respect to Channel A. Accommodates 3 feet difference in signal or sampling-head cables.

NEW

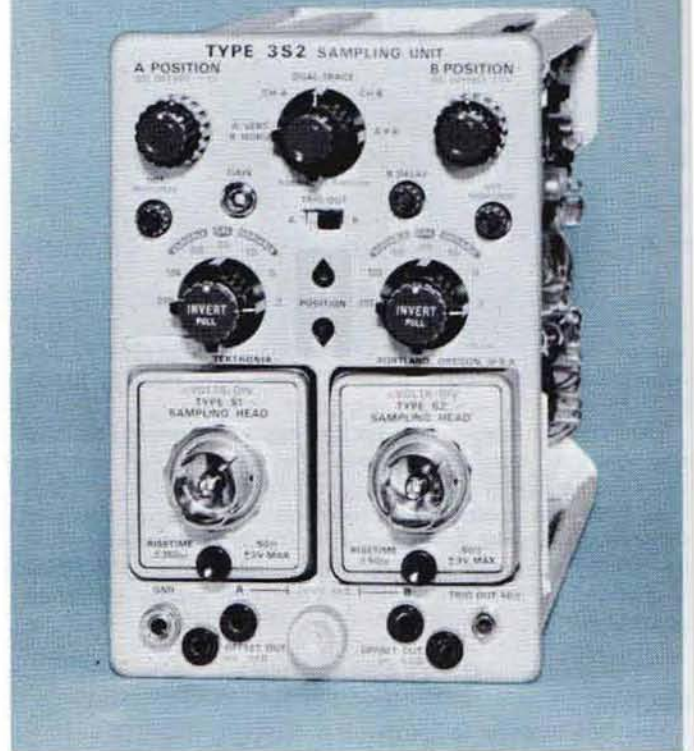

DISPLAY MODES

A only, B only, Dual Trace, Algebraic Addition of A and B signals, and X-Y display of A-vertically and B-horizontally, (for observation of hysteresis loops, phase shift, and similar displays). Independent controls for each channel permit positioning and inverting displays as desired.

VERTICAL OUTPUT

200 mV for each division of displayed signal through 10 k Ω .

WEIGHTS

Net weight	5 1/2 lb	2.5 kg
Domestic shipping weight	≈ 8 1/2 lb	≈ 3.9 kg
Export-packed weight	≈ 12 lb	≈ 5.5 kg

INCLUDED STANDARD ACCESSORIES

7-inch trigger cable with RG58 BNC/BSM connectors (012-0128-00); 18-inch trigger cable with RG58 BNC/BSM connectors (012-0127-00); two instruction manuals (070-0759-00).

OPTIONAL ACCESSORIES

3-ft sampling-head extender, order 012-0124-00

6-ft sampling-head extender, order 012-0125-00

Please refer to Terms and Shipment, General Information page.

TYPE S-1

350-ps SAMPLING HEAD



NEW

- **350-ps SAMPLING HEAD**
- **DC-TO-1 GHz BANDWIDTH**
- **RANDOM NOISE LESS THAN 2 mV (unsmoothed)**

The Type S1 Sampling Head is a low-noise, 350-ps risetime unit with a 50-Ω input impedance. It is designed for use with the Type 3S2 Dual-Trace Sampling Unit and can be plugged into the Type 3S2 or attached by a cable for remote use. A trigger pickoff within the Type S1 provides a trigger signal output from the Type 3S2. When used with the Type 3T2 Random Sampling Sweep Unit, the triggering event may be displayed on the screen without the use of delay lines or a pre-trigger.

CHARACTERISTICS

RISETIME

Less than or equal to 350 ps.

BANDWIDTH

Equivalent to DC to 1 GHz at 3-dB down.

TRANSIENT RESPONSE

+0, -3% or less aberrations in first 5 ns following a step transition; ±0.5% or less after 5 ns (as observed with Type 284 Pulse Generator).

RANDOM NOISE

Equivalent to an input signal of 2 mV or less, unsmoothed; 1 mV, smoothed (tangentially measured).

SIGNAL RANGE

Variable DC offset allows signals between +1 V and -1 V limits to be displayed at 2 mV/div. Signals between +2 V and -2 V limits may be displayed at 200 mV/div. More than one sample is required to display 100% amplitude of signals greater than 500 mV P-P.

INPUT CHARACTERISTICS

Nominally 50 Ω. Safe overload is ±5 V. GR 874 input connectors.

WEIGHTS

Net weight	3/4 lb	0.34 kg
Domestic shipping weight	≈1 1/2 lb	≈0.68 kg

INCLUDED STANDARD ACCESSORIES

5-ns, RG58 cable with GR connectors (017-0512-00); 10X, 50 Ω, GR attenuator (017-0078-00); instruction manual (070-0763-00).

P6040/CT-1 Current Probe, order 015-0041-00

CT-3 Signal Pickoff, order 017-0061-00

VP-1 Voltage Pickoff, order 017-0073-00

P6034 10X Passive Probe, order 010-0110-00

TYPE S-2

50-ps SAMPLING HEAD



NEW

- **50-ps SAMPLING HEAD**
- **DC-TO-7 GHz BANDWIDTH**
- **RANDOM NOISE LESS THAN 10 mV (unsmoothed)**

The Type S2 Sampling Head is a 50-ps risetime unit with a 50-Ω input impedance. It is designed for use with the Type 3S2 Dual-Trace Sampling Unit and can be plugged into the Type 3S2 or attached by a cable for remote use. A trigger pickoff within the Type S2 provides a trigger signal output from the Type 3S2. When used with the Type 3T2 Random Sampling Sweep Unit, the triggering event may be displayed on the screen without the use of delay lines or a pre-trigger.

CHARACTERISTICS

RISETIME

Less than or equal to 50 ps.

BANDWIDTH

Equivalent to DC to 7 GHz at 3-dB down.

TRANSIENT RESPONSE

±5% or less aberrations in first 500 ps following a step transition; ±2% or less after 500 ps (as observed with Type 284 Pulse Generator).

RANDOM NOISE

Equivalent to an input signal of 10 mV or less, unsmoothed; 5 mV, smoothed (tangentially measured).

SIGNAL RANGE

Variable DC offset allows signals between +1 V and -1 V limits to be displayed at 2 mV/div. Signals between +2 V and -2 V limits may be displayed at 200 mV/div. More than one sample is required to display 100% amplitude of signals greater than 200 mV P-P.

INPUT CHARACTERISTICS

Nominally 50 Ω. Safe overload is ±5 V. GR 874 input connectors.

WEIGHTS

Net weight	3/4 lb	0.34 kg
Domestic shipping weight	≈1 1/2 lb	≈0.68 kg

INCLUDED STANDARD ACCESSORIES

5-ns, RG213 cable with GR connectors (017-0502-00); 10X, 50-Ω, GR attenuator (017-0078-00); instruction manual (070-0764-00).

OPTIONAL ACCESSORIES

P6035 100X Passive Probe, order 010-0111-00

Power Divider GR 874-TPD, order 017-0082-00

Coupling Capacitor, GR 874-K, order 017-0028-00

Please refer to Terms and Shipment, General Information page.

TYPE 3S3

350-ps DUAL-TRACE SAMPLING-PROBE UNIT

- **MINIATURE DIRECT-SAMPLING PROBES**
- **100 k Ω , 2 pF INPUT R C**
- **DC-to-1 GHz BANDWIDTH**
- **5 mV/DIV to 100 mV/DIV DEFLECTION FACTOR**
- **RANDOM NOISE LESS THAN 500 μ V (UNSMOOTHED)**

The Type 3S3 Sampling-Probe Unit is a low-noise dual-trace amplifier employing small sampling probes. It has two separate channels with identical characteristics and can operate in any one of five modes for a variety of single, dual-trace and X-Y displays. The Type 3S3 is designed to operate in conjunction with a Type 3T2, 3T77A or Type 3T4 Sampling Sweep Unit in the Type 561A, 564, 567, or 568 Oscilloscopes.

CHARACTERISTICS (2 Identical Channels)

RISETIME

Less than or equal to 350 ps (FAST RISETIME) or approximately 800 ps (LOW NOISE) with a 50- Ω source.

BANDWIDTH

Equivalent to DC-to-1 GHz at 3 dB down.

DEFLECTION FACTOR

5 mV/div to 100 mV/div in 5 calibrated steps, 1-2-5 sequence. Each step accurate within 3%. Variable between steps, extending to 2 mV/div, uncalibrated.

RANDOM NOISE

Equivalent to an input signal of 0.5 mV or less (LOW NOISE), 2 mV or less (FAST RISETIME), unsmoothed with 50- Ω source (tangentially-measured.) A FAST-RISETIME/LOW-NOISE switch allows the operator to trade optimum risetime for optimum noise depending upon particular measurement requirements.

INPUT CHARACTERISTICS

100 k Ω paralleled by 2 pF. Safe overload is ± 10 V.

DC OFFSET RANGE

+0.5 V to -0.5 V. Allows signals between +0.5 V and -0.5 V limits to be displayed at 5 mV/div. Signals between +1 V and -1 V limits may be displayed at 100 mV/div.

TRIGGERING

External only. Pretrigger required unless used with Type 3T2 Random Sampling Sweep Unit.

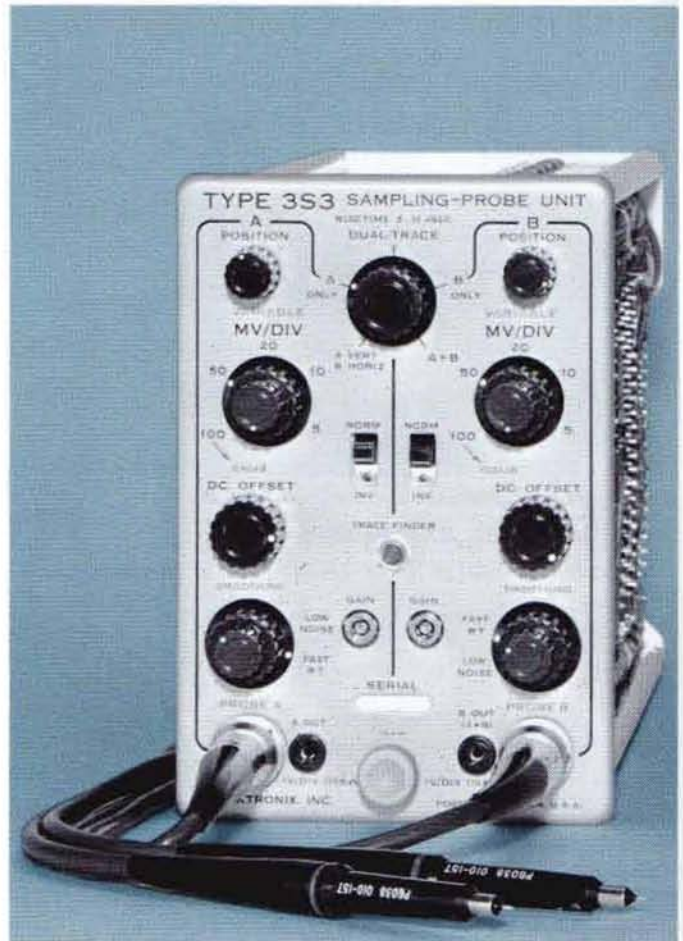

DISPLAY MODES

A only, B only, Dual-Trace, Algebraic addition of A and B signals, and X-Y display of A-vertically and B-horizontally (for observation of hysteresis loops, phase shift and similar displays.) Independent controls for each channel permit positioning and inverting displays as desired. Time coincidence between channels is within 60 ps.

VERTICAL OUTPUT

1 V for each division of displayed signal through 10 k Ω .

SAMPLING PROBES

Included with the Type 3S3, and extremely compact to permit access to miniaturized circuitry. The sampling bridge is contained in the probe to obtain optimum results. Low-frequency response is approximately 3-dB down at 1.5 kHz with the included coupling capacitors; approximately 3-dB down at 150 Hz with the coupling capacitor and 10X attenuator.

WEIGHTS

Net weight	6 $\frac{3}{4}$ lb	3.1 kg
Domestic shipping weight	\approx 13 lb	\approx 5.9 kg
Export-packed weight	\approx 17 lb	\approx 7.7 kg

INCLUDED STANDARD ACCESSORIES

Two P6038 probe packages (010-0156-00); VP-2 voltage pick-off, 50 Ω (017-0077-00); two instruction manuals (070-0347-00).

RANDOM SAMPLING SWEEP UNIT

- **RANDOM OR SEQUENTIAL SAMPLING**
- **NO PRETRIGGER REQUIRED**
- **20 ps/div TO 100 μs/div SWEEP RANGE**
- **WIDE RANGE TIME POSITION**

The Type 3T2 Random Sampling Sweep Unit provides a unique, state-of-the-art advancement in measurement capabilities. This unit may be used in a Type 561A, 564, 567, or 568 Oscilloscope, in conjunction with a Vertical Dual-Trace Sampling Unit.

Random sampling permits observation of the leading edge (or other portions) of signals even when used with vertical units that have no delay lines and without a pretrigger. Random sampling is especially useful with sampling units such as the Type 3S2 with S1 or S2 Sampling Heads or the Type 3S3 with high-impedance sampling probes.

A front-panel switch (START POINT) selects either conventional, sequentially-stepped sampling or random sampling modes of operation.

SWEEP TIME/DIV

100 μs/div to 200 ps/div, 1-2-5 sequence extending to 20 ps/div with X10 DISPLAY MAGNIFIER. Accurate within 3% from 100 μs/div to 2 ns/div, within 5% from 1 ns/div to 200 ps/div. TIME/DIV is a resultant of the combined settings of TIME POSITION RANGE, TIME MAGNIFIER, and DISPLAY MAG. The sweep rate is displayed (digitally) in the TIME/DIV "window" for all combinations of these controls.

DISPLAY MAG

X1 or X10 magnification of the display. Display magnifier accurate within 2%, in addition to specified sweep time/div accuracy.

TIME POSITION RANGE

100 ns, 1 μs, 10 μs, 100 μs, and 1 ms. TIME POSITION and FINE variable controls position start of the display through an interval equal to TIME POSITION RANGE setting.

SAMPLES/DIV

Continuously variable adjustment of samples displayed per horizontal division from approx 5 samples/div to an immeasurable number of samples/div. Allows optimum adjustment of display rate and dot density.

DISPLAY MODES

Normal (repetitive), Single Sweep, Manual, or Ext. Horiz. For external input, deflection factor is adjustable from 1.5 V/div to 15 V/div. Front-panel START button for single-sweep operation.

PULSE OUTPUT

Approximately 150 mV into 50 Ω, negative going. Coincides with trigger recognition.

TRIGGERING

SOURCES (AC-coupled): Internal—if Sampling Unit contains a trigger pickoff. External, both 1-MΩ (for hi-Z probes) and 50-Ω terminated inputs.

JITTER: Depends on signal shape, repetition rate and amplitude; Less than or equal to 30 ps under optimum conditions.



PULSE TRIGGERING

SOURCE	REPETITION RATE	AMPLITUDE*
EXTERNAL 1-MΩ/UHF Sync input	10 Hz to 100 MHz 600 MHz to 3 GHz	10 mV to 500 mV (100 V max DC)
EXTERNAL 50-Ω input	10 Hz to 600 MHz	5 mV to 250 mV (5 V max DC)

*Either polarity. Minimum rise rate is 150 mV/μs.

SINEWAVE TRIGGERING

SOURCE	FREQUENCY	AMPLITUDE
EXTERNAL 1-MΩ/UHF Sync input	10 kHz to 100 MHz (+ polarity) 100 kHz to 100 MHz 500 MHz to 3 GHz (- polarity)	10 mV to 500 mV peak-to-peak
EXTERNAL 50-Ω input	100 kHz to 600 MHz	10 mV to 250 mV peak-to-peak

HORIZONTAL OUTPUT

1 V for each division of displayed signal through 10 kΩ.

WEIGHTS

Net weight	6½ lb	3 kg
Domestic shipping weight	≈11 lb	≈5 kg
Export-packed weight	≈17 lb	≈7.7 kg

INCLUDED STANDARD ACCESSORIES

5-ns cable, RG58 with BNC connectors (012-0057-01); 10X 50-Ω attenuator, BNC (011-0059-00); GR-to-BNC female adapter (017-0063-00); GR-to-BNC male adapter (017-0064-00); two instruction manuals (070-0631-00).

Please refer to Terms and Shipment, General Information page.

TYPE 3T4

PROGRAMMABLE SAMPLING SWEEP UNIT

- PROGRAMMABLE TIME/DIV
- PROGRAMMABLE DELAY
- 1 ns/DIV TO 200 μ s/DIV CALIBRATED SWEEP RANGE
- CALIBRATED SWEEP DELAY

The Type 3T4 Sampling Sweep Unit extends the convenience of operation of the Type 567 or 568 Digital Readout Systems by providing remote control of the horizontal time base. This unit is compatible with the following equipment: 3S1, 3S2, 3S3, and other 3-series Sampling Units; 561A, 564, 567, and 568 Indicator Units; 6R1A, and 230 Digital Units; the 262 Programmer; and the 283 Real Time Adapter.

The multiple-pin connector on the front panel, also available on the rear panel, affords external control of equivalent-time sweep steps, delay time, samples per sweep, normal or single-display modes, and single-display start. These operations are obtained through the grounding of certain pins of the front-panel connector. Delay time is determined by the value of resistors added externally. For real-time measurements, using the Type 283 Adapter, only TIME/DIV can be remotely controlled.

REMOTELY PROGRAMMABLE FUNCTIONS

Equivalent-Time Sweep Ranges.

Delay Time.

Samples per Sweep.

Normal or Single-Display Modes.

Single-Display Start (when remotely programmed for SINGLE DISPLAY).

SWEEP TIME/DIV

Equivalent-Time Sampling: 1 ns/div to 200 μ s/div in 17 calibrated steps, 1-2-5 sequence. Each step accurate within 3%. Variable between steps.

Real-Time Sampling: 1 ms/div to 1 s/div. External clock, trigger, and single-display start inputs are required. See Type 283.

DISPLAY MAGNIFIER

X1 or X10 magnification of the display horizontally (digital readout not affected).

DELAY RANGE

1 ns/div through 0.1 μ s/div—1000 ns delay range.

0.2 μ s/div through 10 μ s/div—100 μ s delay range.

20 μ s/div through 100 μ s/div—1000 μ s delay range.

(No delay range for 200 μ s/div sweep range, or in real-time sampling mode.)

SAMPLES/SWEEP

100 or 1000 (digital readout decimal information correct only for 1000 samples/sweep).

SWEEP MODES

Normal (repetitive), Single Sweep, Manual, or External Horizontal for external input (deflection factor is adjustable from 5 V/div to 25 V/div). Front-panel START button for single-sweep operation.

TRIGGERING

SOURCES (AC-Coupled): Internal—if Sampling Unit contains a trigger pickoff; External, 50- Ω terminated input.

AMPLITUDE (EXT): Sinewaves, 10 mV to 500 mV peak-to-peak; Pulses, 5 mV to 250 mV, either polarity.



REPETITION RATE: Sinewaves from 100 kHz through 1 GHz. Pulses from 30 Hz through 1 GHz.

JITTER: Depends on signal shape, repetition rate and amplitude; ≤ 200 ps under optimum conditions.

PULSE OUTPUT

Approximately 500 mV into 50 Ω negative going. Coincides with trigger recognition.

HORIZONTAL OUTPUT

1 V for each division of displayed signal through 10 k Ω .

WEIGHTS

Net weight	5 $\frac{3}{4}$ lb	2.6 kg
Domestic shipping weight	≈ 11 lb	≈ 5.0 kg
Export-packed weight	≈ 16 lb	≈ 7.3 kg

INCLUDED STANDARD ACCESSORIES

5-ns 50- Ω RG58 cable with BNC connectors (012-0057-01); 10X 50- Ω BNC attenuator (011-0059-00); GR-to-BNC female adapter (017-0063-00); GR-to-BNC male adapter (017-0064-00); circuit board connector (388-0805-00); two instruction manuals (070-0439-00).

OPTIONAL ACCESSORIES

Type 283 Real-Time Adapter

Connector, 19-pin male. Mates with front-panel connector on Type 3T4 for remote programming, order 131-0388-00

Remote Program Cable, 10 ft, 19-pin male and 36-pin male connectors, order 012-0101-00

Please refer to Terms and Shipment, General Information page.

TYPE 3T77A

SAMPLING SWEEP UNIT

- TRIGGERING THROUGH 1 GHz
- 20 ps/DIV TO 10 μs/DIV CALIBRATED TIME BASE
- WIDE-RANGE TIME POSITION
- SINGLE-DISPLAY PROVISION
- RECORDER OUTPUT

The Type 3T77A Sampling Sweep Unit provides sub-nano-second capabilities when used in conjunction with a Type 3S1, 3S2 or 3S3 Sampling Unit in a Type 561A, 564, 567 or 568 Oscilloscope. In the Type 567 (with Type 6R1A) or 568 (with Type 230), information can be presented in digital as well as analog form.



CHARACTERISTICS

SWEEP TIME/DIV

10 μs/div to 200 ps/div in 15 calibrated steps, 1-2-5 sequence, extending to 20 ps/div with X10 TIME EXPANDER. Each step accurate within 3%. Variable between steps.

TIME EXPANDER

X10 expansion of time scale while maintaining a constant number of dots per division.

TIME POSITION

Provides a sweep delay range corresponding to at least one screen diameter, unexpanded and at least ten screen diameters (100 div) when expanded.

DOT DENSITY

Either 10 or 100 dots/div.

SWEEP MODES

Normal (repetitive), Single Sweep, Manual, or External Horizontal. For external input, deflection factor is adjustable from 5 V/div to 25 V/div. Front panel START button for single-sweep operation.

TRIGGERING

SOURCES (AC-coupled): Internal—if Sampling Unit contains a trigger pickoff. External, 50-Ω termination input.

AMPLITUDE (External): Sinewaves, 10 mV to 400 mV peak-to-peak; Pulses, 10 mV to 200 mV, either polarity. 5-V maximum DC input.

REPETITION RATE: Sinewave triggering or synchronizing from 100 kHz through 1 GHz. Pulse Triggering from 30 Hz through 1 GHz.

JITTER: Depends on signal shape, repetition rate and amplitude; less than or equal to 50 ps under optimum conditions.

PULSE OUTPUT

Approximately 150 mV into 50 Ω, positive going, coincides with trigger recognition.

HORIZONTAL OUTPUT

1 V for each division of displayed signal through 10 kΩ.

WEIGHTS

Net weight	5 ³ / ₄ lb	2.6 kg
Domestic shipping weight	≈10 ³ / ₄ lb	≈4.9 kg
Export-packed weight	≈20 lb	≈9 kg

INCLUDED STANDARD ACCESSORIES

5-ns cable, RG58 with BNC connectors (012-0057-01); 10X 50-Ω BNC attenuator (011-0059-00); GR-to-BNC female adapter (017-0063-00); GR-to-BNC male adapter (017-0064-00); two instruction manuals (070-0546-00).

Please refer to Terms and Shipment, General Information page.

Digital Readout Introduction

- **ANALOG DISPLAYS**
- **OSCILLOSCOPE MEASUREMENTS IN DIGITAL FORM**
- **DIGITAL READOUT**
 - PULSE AMPLITUDE**
 - PULSE RISE AND FALL TIME**
 - PULSE WIDTH**
 - TIME INTERVAL**
- **INCREASED MEASUREMENT SPEEDS**
- **MEASUREMENT LIMIT SETTINGS**
- **DIGITAL RECORDING OUTPUTS**
- **GO/NO-GO OUTPUTS**
- **EXTERNALLY PROGRAMMABLE**
- **PLUG-IN VERSATILITY**

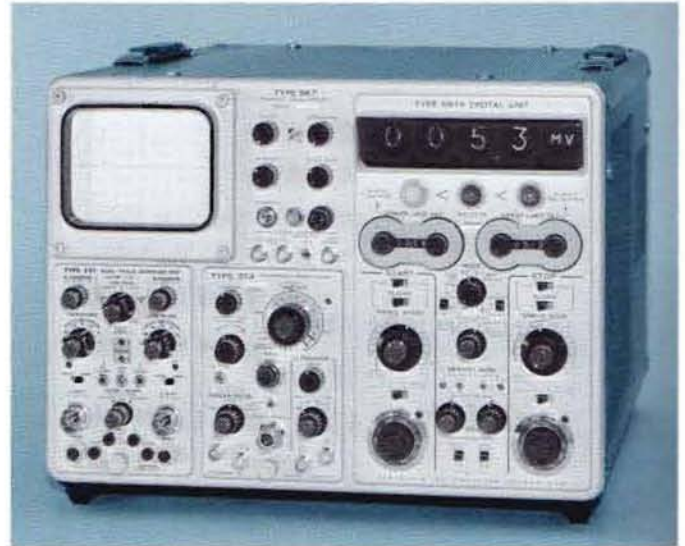

DIGITAL READOUT PLUS ANALOG DISPLAYS

The Type 568/230 and Type 567/6R1A Digital Readout Oscilloscope systems provide digital readout of measurements that are displayed in analog form on the CRT. They enable the engineer, technician, or production worker to make dynamic switching-time measurements with greater speed, repeatability, and convenience than has been possible by making measurements directly from a cathode-ray oscilloscope display.

The Type 230 and Type 6R1A Digital Units have the ability to make a wide variety of repetitive-pulse measurements digitally without operator interpretation or error. These test measurements include pulse voltages, risetime, delay time, storage time, pulse width and many other specific measurements. The measurements are read out directly in four-digit resolution. The decimal point and unit of measure (ns, μ s, ms, s, mV, V) are automatically presented when time/div, amplitude/div or measurement program is changed. Measurement limits may be selected to provide Go/No-Go indications.

Front panel controls can be set up manually or they can be set, or changed, by external programming when rapid automatic test measurements are desired. Output connectors are provided on the rear panel to permit recording of the displayed measurement digital information. This allows permanent collection of data on a printer, card punch or similar device.

Digital Readout Introduction

The Type 567 Readout Oscilloscope and Type 6R1A Digital Unit can make up to 8 measurements per second with increased convenience and repeatability over conventional oscilloscopes. With Type 262 Programmers, the Type 6R1A Digital Unit can be externally programmed to provide up to 24 different measurement functions and measurement limits. Programs are selected by a front-panel switch on the Type 262 or automatically with the addition of automatic sequence cards. Output connectors provide the digital readout information in parallel form. The Type 567/6R1A Digital Readout Oscilloscope offers digital measurement capabilities and it can provide automatic measurement capabilities with the Type 262 Programmer. See pages 196 through 201 for more complete information.

The Type 568 Oscilloscope and Type 230 Digital Unit comprise a new high-speed solid-state digital oscilloscope system that provides maximum measurement flexibility. It is a step ahead in measurement capabilities with increased measurement speed, increased programming ease, BCD data outputs and solid-state reliability with extensive use of integrated circuits. The Type 568/230 can make up to 50 measurements per second and all of its measurement functions are easily programmed by grounding or opening its program lines. With proper programming techniques, the measurement speed can be increased to more than 100 measurements per second. The Type 568/230 has automatic polarity indication and increased measurement resolution. The data output is in BCD code and includes polarity, numbers, units, multiplier and limits. The Type 568/230 Digital Oscilloscope system offers maximum measurement flexibility and programming ease. See pages 202 through 206 for more complete information.

TYPICAL MEASUREMENT CAPABILITIES

DUAL-TRACE DISPLAY SHOWING TYPICAL MEASUREMENTS		
MEASUREMENT	6R1A PROGRAM	
	Start	Stop
Risetime A	+10% A	+90% A
Falltime A	-90% A	-10% A
Risetime B	-10% B	-90% B
Falltime B	+90% B	+10% B
Delay A to B	+10% A	-10% B
Storage A to B	-90% A	+90% B
Turn on A to B	+10% A	-90% B
Turn off A to B	-90% A	+10% B
Width A	+50% A	-50% A
Width B	-50% B	+50% B

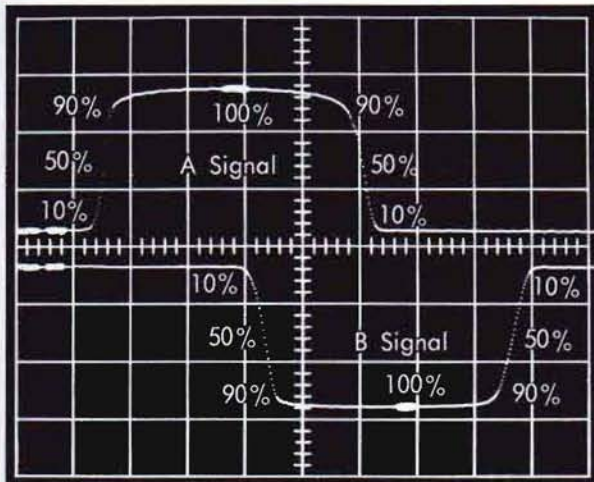

1. **TIME MEASUREMENTS** can be made between 2 points on the same waveform, or between separate points on Channel A and Channel B. Points are determined (1) as a percentage of signal amplitude, (2) as a particular voltage level referenced to the signal, or (3) at a desired interval during the sweep. With the horizontal plug-ins presently available, time differences from 20 ps and up to 10 s can be displayed and read out digitally.
2. **VOLTAGE MEASUREMENTS** can be made between any 2 points on the waveform or to either the positive or negative peak signal within the positionable reference zones.
3. **PERMANENT RECORDS** of each test can be made with external equipment. The Digital Units provide digital and go/no-go outputs for use with a card punch, tape perforator, and numerical printers. The Type 6R1A provides parallel 10-line data output and the Type 230 provides parallel BCD (1 2 4 8) data output.
4. **EXTERNAL PROGRAMMING** permits rapid sequencing of measurements and test limits without changes of the front-panel controls.
5. **LIMIT SELECTION** presets digital comparators for automatic readings in three categories: (1) less than lower limit, (2) greater than upper limit, and (3) mid-zone—between upper and lower limits.

READOUT OSCILLOSCOPES

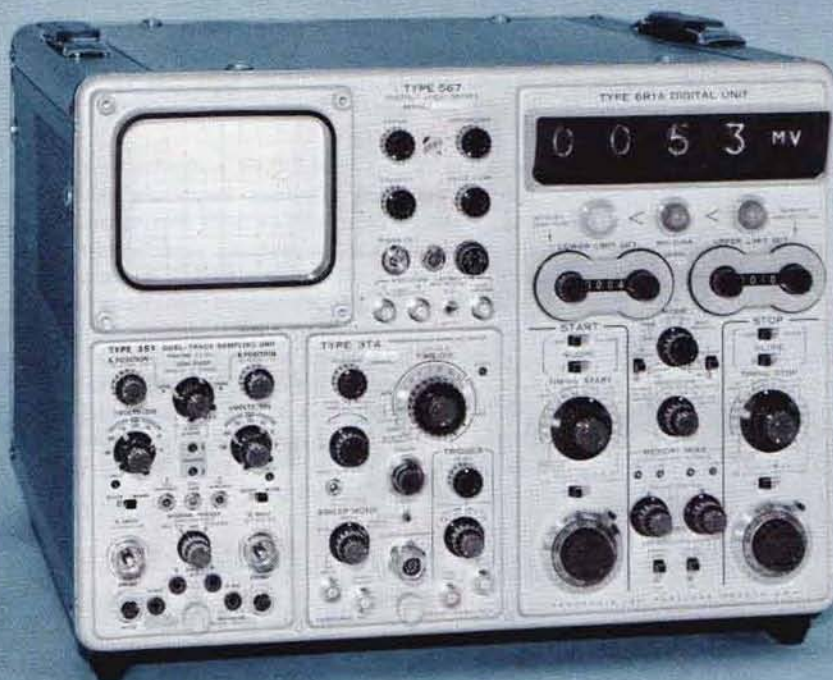

- **DIGITAL READOUT OF RISETIME, AMPLITUDE, AND TIME DIFFERENCES**
- **SELECTABLE HIGH AND LOW NO-GO LIMITS**
- **ILLUMINATED NO-PARALLAX GRATICULE**

The Type 567 and R567 Readout Oscilloscopes are designed to provide digital readout of the waveform displayed on the cathode-ray tube. Digital readout provides greater accuracy, speed, and convenience of measurement over conventional CRT displays.

Using an amplifier and a time-base unit that provides digital readout information, and the Type 6R1A Digital Readout Unit, the Type 567 system is well suited for repetitive-pulse measurements. The system can be further extended through use of the Type 262 Programmer when faster measurements are desired.

CHARACTERISTIC SUMMARY

VERTICAL

Vertical deflection characteristics are determined by choice of 2-Series and 3-Series Amplifier Plug-In Units. See chart of Digital Readout Combinations for units which will provide both analog and digital displays.

HORIZONTAL

Horizontal deflection characteristics are determined by choice of 2-Series and 3-Series Amplifier and Time-Base Units. See chart of Digital Readout Combinations for units which will provide both analog and digital displays.

CRT

DISPLAY AREA—8 x 10 div. (Each major div = 1 cm).

ACCELERATING VOLTAGE—3.5 kV.

PHOSPHOR—P2.

OTHER

AMPLITUDE CALIBRATOR—5V and 0.5V into $\geq 1 M\Omega$ or 500 mV and 50 mV into 50 Ω . Repetition rate is 20 kHz or 1 kHz.

POWER REQUIREMENTS—105 to 125 V or 210 to 250 V. Line frequency is 50 to 60 Hz. Power consumption is approx 405 watts.

DIGITAL READOUT COMBINATIONS

Digital and analog displays are simultaneously presented on the Type 567 Readout Oscilloscope and Type 6R1A Digital Unit. A Digital Readout Combination consists of a Type 567/6R1A and any of the following combinations of amplifier and

time-base Plug-In Units. Other 2-Series and 3-Series Plug-In Units can be used for normal analog CRT display, but do not provide digital readout.

PLUG-IN UNITS							
VERTICAL				TIME BASE			
TYPE	MINIMUM DEFLECTION FACTOR	T _R	BANDWIDTH	TYPE	CALIBRATED SWEEP RANGE		
3S1	2 mV/div	350 ps	DC to 1 GHz	3T2	200 ps/div to 100 μs/div plus X10 magnifier		
3S2	2 mV/div			3T4*	Programmable 1 ns/div to 200 μs/div		
S1		350 ps	DC to 1 GHz	3T77A	200 ps/div to 100 μs/div plus X10 magnifier		
S2		50 ps	DC to 7 GHz	3B2	2 μs/div to 1 s/div		
3S3	5 mV/div	350 ps	DC to 1 GHz				
3A2	10 mV/div	700 ns	DC to 500 kHz				

*Type 3T4, when used with Type 283 Real Time Adapter has an additional range of CALIBRATED SWEEP from 1 ms/div to 1 s/div, but no TIME POSITION in "REAL TIME" operation. Type 3T4 can also be programmed through a front panel connector. (See Type 3T4 catalog page.)

CHARACTERISTICS

AMPLITUDE CALIBRATOR

Front-panel selection of squarewave outputs of 20 kHz, crystal-controlled, accuracy ±0.1%, or approx 1 kHz, RC time-constant controlled. Output voltages are 5 V and 0.5 V into 1 MΩ or greater, or 500 mV and 50 mV into 50 Ω. Connectors are BNC.

TEKTRONIX CRT

5-inch rectangular CRT with 3.5-kV accelerating potential. A P2 phosphor is normally supplied.

ILLUMINATED INTERNAL GRATICULE

Edge lighted graticule is marked in 8 vertical and 10 horizontal divisions (centimeters). Centerlines are also marked in 2-mm increments. Scale illumination is adjustable with a front-panel control.

DC-VOLTAGE SUPPLIES

Electronically regulated to compensate for widely varying line conditions. Separate regulated heater supply is included. Type 6R1A is also powered from these supplies.

POWER REQUIREMENTS

105 V to 125 V or 210 V to 250 V, 50 to 60 Hz, typically 405 watts. A thermal cutout switch prevents overheating of the instrument. Instrument is normally factory wired for 105 V to 125 V, but may be ordered wired for 210 V to 250 V.

TYPE 567 DIMENSIONS AND WEIGHTS

Height	13 ³ / ₄ in	34.9 cm
Width	16 ⁷ / ₈ in	42.8 cm
Depth	23 ³ / ₁₆ in	58.8 cm
Net Weight	48 ³ / ₄ lb	22.2 kg
Domestic shipping weight	≈76 lb	≈34.6 kg
Export-packed weight	≈97 lb	≈44.1 kg

TYPE RM567 DIMENSIONS AND WEIGHTS

Height	12 ¹ / ₄ in	31.1 cm
Width	19 in	48.3 cm
Rack Depth	22 ³ / ₁₆ in	56.4 cm
Net weight	50 lb	22.7 kg



Domestic shipping weight	≈ 85 lb	≈38.6 kg
Export-packed weight	≈106 lb	≈48.2 kg

INCLUDED STANDARD ACCESSORIES

3 to 2-wire adapter (103-0013-00); 3-conductor power cord (161-0010-03); clear CRT protector plate (387-0935-00); smoke gray filter (installed) (378-0560-00); two instruction manuals (Type 567, 070-0322-01); (Type RM567, 070-0348-01). Also included with Type RM567: pair mounting slides (351-0086-00); set mounting hardware.

OPTIONAL ACCESSORIES

SUPPORTING CRADLES

When Type RM567 is used in a backless rack, these cradles are necessary for rear slide support. Order Part Number 040-0346-00

Please refer to Terms and Shipment, General Information page.

TYPE 6R1A

DIGITAL UNIT

- PRESENTS OSCILLOSCOPE MEASUREMENTS IN DIGITAL FORM
- DIGITAL READOUT PARAMETERS
 - PULSE AMPLITUDE
 - PULSE RISE AND FALL
 - PULSE WIDTH
 - TIME INTERVAL
- PROVISIONS FOR EXTERNAL PROGRAMMING AND SERIAL READOUT
- LIMIT SETTINGS AND INDICATORS

NOTE: In this presentation, any reference to A or B Channel or A or B trace designates use of a dual-trace unit in the vertical channel of the Type 567 Readout Oscilloscope.

The Type 6R1A Digital Unit equips a Tektronix Type 567 or Type RM567 Oscilloscope for digital readout. Used with vertical and timing units, the Type 6R1A enables presentation of digital data for a wide variety of repetitive-pulse measurements. The digital presentations can designate voltage measurements, time-difference measurements between similar pulses, and time-difference measurements between percentages of pulse amplitudes. In addition, the Type 6R1A has provision for external programming to facilitate automatic sequential operations. The Type 6R1A enables these time and amplitude measurements to be read directly with up to 4 digit units of measurement.

Output connectors are provided on the rear panel to permit recording of the displayed digits on a printer, card punch, tape recorder, electric typewriter, etc.

The 6R1A contains the circuitry for the analog to digital and digital readout functions of the Type 567 Readout Oscilloscope. The characteristics are described by giving the purpose of each front-panel control.

GO/NO-GO CONTROLS

LOWER LIMIT SET presets the lower limit. Any digital reading less than the lower limit causes the LOWER LIMIT indicator to light.

UPPER LIMIT SET presets the upper limit. Any digital reading greater than the upper limit causes the UPPER LIMIT indicator to light. Readings between the lower and upper limits cause the MID-ZONE indicator to light.

MODE SWITCH

The type of measurement to be made (time or voltage) is selected by the Mode Switch.

TIME STOP (—) START sets the 6R1A to measure time durations set between the start and stop of timing circuits.



VOLTAGE A sets the Type 6R1A to measure voltage between A Channel 0% and 100% memory zones. Polarity is selected by an adjacent slide switch.

VOLTAGE B sets the Type 6R1A to measure voltage between B Channel 0% and 100% memory zones. Polarity is selected by an adjacent slide switch.

EXTERNAL PROGRAM sets the Types 6R1A to accept programming from an external source, such as the Tektronix Type 262 Programmer. The variety and flexibility of measurements possible with external programming are even greater than those possible through use of the Type 6R1A front-panel controls and measurements and limits can be changed more rapidly.

RESOLUTION SWITCH

Time measurements are performed by gating clock-pulses during the measurement interval. The clock in the case of sampling is the samples per unit equivalent time. For instance, sweep speed = 10 ns/div, samples/div = 100, then equivalent time/sample = 0.1 ns. If a measurement interval occupied 2.5 div, 250 samples would be registered in the digital readout counter. Reading would be 25.0 ns on the readout indicator.

AVERAGE 10 SWEEPS-LO minimizes random noise that could be associated with a measurement. The digital readout counter registers 10 timing intervals (sweeps) and automatically divides the reading by 10. The unit's numerical readout indicator is rendered inoperative so no reading shows even though its scalar is operating. For sweep speed with multipliers of 2 or 5 the counter only registers 1 out of 5 or 2, respectively, clock-pulses and repositions the decimal point to give the correct reading.

AVERAGE 10 SWEEPS-HI permits obtaining reading to high resolution using all four decades. Same as LO except that the unit's numerical readout indicator is restored to operation.

ONE SWEEP-LO registers one sweep only in the digital readout counter.

ONE SWEEP-UNSCALED enables obtaining maximum resolution in just one sweep in the 2 and 5 multiplier positions. Only one sweep is used to fill the digital counter. The reading on the indicator will be only relative on the 2 and 5 multiplier positions of the plug-ins. Decimal points and units of measurement are not indicated in this position to show that readings are only proportional to time.

DISPLAY TIME CONTROL

A control, continuously variable between approximately 5 s and 0.1 s, holds the display for the time needed to observe readings or operate peripheral equipment. (Can be modified for variable control between 1 s and 10 ms for use with high-speed automatic testing.)

MEMORY MODES

The Type 6R1A has 2 internally-selected memory modes: averaging and peak to peak. The mode of operation is made apparent by neon indicators on the front panel. When Types 3A2 and 3B2 Plug-In Units are used, digital readout of amplitude requires an input waveform with constant amplitude for at least 5 μ s, in order to establish a 100% reference level.

AVERAGE MODE stores the average DC level of the signal occurring during the 0% and 100% memory zones, to develop **TIMING START** and **TIMING STOP** percentage levels. Zones are adjustable in width and positionable on the sweep.

PEAK TO PEAK MODE stores the most negative and most positive levels of the signal occurring during the 0% and 100% memory zones, respectively. Zones are adjustable in width from 1 div to 10 div and positionable on the sweep.

ZONE POSITIONING CONTROLS

A 0% and 100% controls position the 0% and 100% references on the displayed waveform. Each zone representing a selected portion of the total sweep is positionable throughout 9 div or more of the A sweep.

B 0% and 100% controls duplicate on Channel B the functions of A 0% and 100% positioning.

0% AND 100% **INTENSIFICATION** turns on and off two intensity markers on each trace at 0% and 100% zones.

START-TO-STOP INTENSIFICATION turns on and off the start-to-stop zone on the displayed waveform (allows verifying start-to-stop interval).

START-TIMING CONTROLS

These controls program the initiation of timing.

+SLOPE,—SLOPE selects which direction of the waveform will be used to start the timing.

FIRST, SECOND (Cycle) allows selecting start-timing on either the first or second cycle of the waveform through the selected start-timing setting.

TIMING START provides 7 calibrated percentage steps at 10, 20, 27, 50, 73, 80 and 90% from either A or B trace (in references to 0% and 100% zone amplitude). Automatically starts timing at the selected percentage. The 27% and 73% positions are useful for time constant measurements.

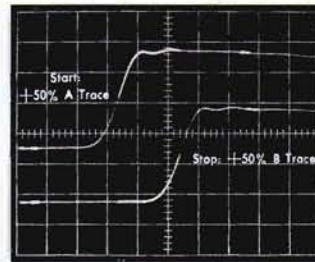

DELAY-TIME INTERVAL MEASUREMENT

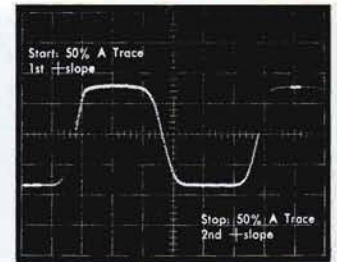

PERIOD (1 CYCLE) MEASUREMENT

MANUAL START enables start-timing at any point on the waveform. Continuously variable over 9 div or more of the sweep.

START VOLTAGE + OR — selects which polarity from 0% zone the waveform will start timing after reaching the amplitude as set by the **START VOLTAGE** 10-turn dial setting.

START VOLTAGE 10-turn dial permits start-timing continuously variable between 0-10 CRT divisions of amplitude from 0% zone reference.

STOP-TIMING CONTROLS

Program the termination of the timing interval. Identical in capability and operation to the start-timing controls in all other respects.

OTHER CHARACTERISTICS

READOUT is in a numerical range from .0001 to 9999. Display time is variable between approximately 5 s and 0.1 s. Units of measure include: microvolts, millivolts, and volts; nanoseconds, microseconds, milliseconds, and seconds.

DIGITAL READOUT ACCURACY of the 6R1A, in addition to providing measurement results in fast, convenient digital form, reduces the magnitude of measurement errors that are attributable to the visual resolution difficulties of a cathode-ray tube display. For assistance in determining system accuracy in specific applications, consult your Field Engineer.

INPUT is internally connected from horizontal and vertical plug-in units. Power requirements, AC and DC voltages for circuitry operation are supplied by Type 567 or RM567.

WEIGHTS

Net weight	14 ³ / ₄ lb	6.7 kg
Domestic shipping weight	≈25 lb	≈11.4 kg
Export-packed weight	≈31 lb	≈14.1 kg

INCLUDED STANDARD ACCESSORIES

Two instruction manuals (070-0411-00).

OPTIONAL ACCESSORIES

See information on Type 262 Programmer and associated accessories. For custom arrangements, one or both of the following connectors will be necessary.

41-pin Connector, for external programming and control, order 131-0239-00

55-pin Connector, for external read-out (limit lamps, etc.), order 131-0240-00

Please refer to Terms and Shipment, General Information page.

TYPE 262

PROGRAMMER



- **FOR 567/6R1A DIGITAL READOUT COMBINATION**
- **UP TO 8 DIFFERENT MEASUREMENTS FOR EACH TYPE 262**
- **UP TO 3 TYPE 262's OPERATE TOGETHER FOR 24 MEASUREMENTS**
- **UP TO 8 MEASUREMENTS PER SECOND**
- **PUSH BUTTON MEASUREMENT SELECTION OR**
- **OPTIONAL AUTOMATIC SEQUENCE OF MEASUREMENTS***
- **OPTIONAL SYNCHRONOUS CONTROL OF OTHER EQUIPMENT**

The Type 262 Programmer makes it possible to remotely control the measurement and readout capabilities of the 6R1A Digital Unit. Any set of up to eight different pre-selected time or voltage measurements can be made with each Type 262 used. The measurements are made from the same signal as is displayed on the Type 567 cathode-ray-tube screen, using plug-in units that furnish digital data to the 6R1A Digital Unit.

The kind of measurement selected is determined by the circuits on each of eight plug-in circuit cards that are plugged into the Type 262 during operation. Other plug-in program cards may be interchanged for a different set of measurements when different measurements are required.

* Automatic sequencers are required.

Up to three Type 262's may be used together at any one time to make up to 24 different tests or measurements without interchanging program cards.**

When a Type 6R1A is under the control of a Type 262 the circuits on the program cards take the place of circuits otherwise selected from the front panel of the 6R1A. Each wired program card represents a particular combination of some front panel control settings on the 6R1A.

PROGRAM CARDS

Plug-in program cards come ready for wiring. Cards are wired by soldering in appropriate jumpers and resistors according to instructions in the manual for the 262.

Each card is wired for a particular time or amplitude measurement. Examples are: risetime, delay time, pulse duration, pulse amplitude, time interval between two pulses. Upper and lower test limits can also be selected by wiring the cards as instructed.

If a change of measurement is desired, the plug-in program cards can be removed and other pre-wired cards easily inserted. Or the cards can be easily rewired.

AUXILIARY EQUIPMENT CONTROL

The Type 262 also accommodates 8 auxiliary equipment plug-in programming cards. The connectors from the auxiliary cards have parallel connections to 54 control lines available at the rear-panel of the Type 262 for controlling signal attenuators, signal generators, trigger source switches, signal switches, power supplies, etc., in step with the 6R1A measurement sequence.

** Cable capacitance and environmental noise limit the number of programmers that can be used in series.

MANUAL CONTROL

Front-panel push-buttons allow manual selection of measurements. The sequence is determined by the operator and any step in a program can be held for as long a period as needed. The measurement rate is determined by the Type 6R1A.

EXTERNAL CONTROL

Measurements can be selected externally through control lines available at the rear-panel connector. Selection is by contact closure to ground.

AUTOMATIC SEQUENCE CONTROL

The Type 262 is pre-wired to facilitate the installation of an Automatic Sequencer consisting of a synchronizer board and a counter board. This accessory will automatically control sequence of up to 8 measurements per Type 262.

Front-panel switches allow an automatic sequence to be interrupted in accordance with pre-established upper and lower limits. Any combination of the upper, middle, or lower limits can be used.

The position of the boards can be interchanged to achieve any particular sequence of measurements wanted.

The Automatic Sequencer can be synchronized with data recording devices such as printers, card punches, or with various test fixtures.

Both manual push-button control and external control are still available when the Automatic Sequencer is installed.

Up to three Type 262 Programmers can be used in series for a total of 24 different measurement programs. For automatic sequencing, each individual Type 262 requires an Automatic Sequencer accessory.

MEASUREMENT RATE

WITHOUT AUTOMATIC SEQUENCER

The measurement rate is governed by the Type 6R1A display time of 0.1 to 6 seconds, and is also dependent upon the sweep time.

WITH AUTOMATIC SEQUENCER

With the Automatic Sequencer installed, the measurement rate can be synchronized with auxiliary equipment or can be determined by the Type 567 and Type 262.

In a non-synchronized mode of operation, the measurement rate is determined by the sum of the Type 6R1A display time and the Type 262 display time. Display time of the Type 262 is continuously variable within the range of 50 to 500 milliseconds. In this mode, up to 8 measurements per second can be made.

In a synchronized mode of operation, the display is held, upon completion of a measurement, until an external completion pulse is received. In the synchronized mode, up to 6 measurements per second can be made.

POWER REQUIREMENTS

105 V to 125 V or 210 V to 250 V, 50 to 60 Hz, typically 35 watts. Instrument is normally factory wired for 105 V to 125 V, but may be ordered wired for 210 V to 250 V.

MECHANICAL FEATURES

The Type 262 mounts in a standard 19 inch rack with slide-out tilt-lock tracks that permit it to be pulled forward, tilted, and locked in any of five positions for convenient programming and servicing. Cabinet feet are included for installation when not rack-mounted.

DIMENSIONS AND WEIGHTS

Height	5 $\frac{1}{4}$ in	13.3 cm
Width	19 in	48.3 cm
Depth	17 $\frac{9}{16}$ in	44.6 cm
Net weight	21 $\frac{3}{4}$ lb	9.9 kg
Domestic shipping weight	≈57 lb	≈26.0 kg
Export-packed weight	≈80 lb	≈36.4 kg



INCLUDED STANDARD ACCESSORIES

Eight program cards (018-0007-00); resistor kit (016-0056-00); cabinet feet kit (016-0052-00); pair mounting tracks (351-0085-00); set, mounting hardware; 3-conductor power cord (161-0024-00); 3 to 2-wire adapter (103-0013-00); 6R1A to 262 cable (012-0081-00)*; two instruction manuals (070-0399-00).

*If the Type 262 is to be used with another Type 262, indicate on your order that you need a 262/262 cable (012-0082-00) rather than a 262/6R1A cable (012-0081-00).

OPTIONAL ACCESSORIES

PROGRAM CARDS

Each card can be wired for a particular time or amplitude measurement, permitting easy plug-in change of program. Eight cards are supplied with Type 262 as standard accessories. PROGRAM CARD, order 018-0007-00

RESISTOR KIT

Contains 176, $\frac{1}{4}$ watt, 1% resistors for use in wiring program cards. One kit is supplied with Type 262 as standard accessories. RESISTOR KIT, order 016-0056-00

AUTOMATIC SEQUENCER ACCESSORY

A sequencer, composed of a synchronizer board and a counter board, provides for automatic scan of up to 8 programs per Type 262.

AUTOMATIC SEQUENCER, order 040-0331-00

SYNCHRONIZER BOARD, order 018-0005-00

COUNTER BOARD, order 018-0006-00

AUXILIARY PROGRAMMING CARDS (not furnished with Type 262)

The Type 262 accommodates 8 auxiliary plug-in programming cards. Each card has gold, through-hole plating for best possible electrical contact.

CARD with 11 reed relay assembly

Order 018-0003-00

CARD only, order 018-0004-00

Please refer to Terms and Shipment, General Information page.

OSCILLOSCOPES



- **ANALOG DISPLAYS OF ANALOG/DIGITAL MEASUREMENT SYSTEM**
- **PROVIDES MEASUREMENT INFORMATION FOR TYPE 230 DIGITAL UNIT**
- **ILLUMINATED NO-PARALLAX GRATICULE**
- **SOLID-STATE DESIGN**

Type 568 and Type R568 Readout Oscilloscopes are designed for use with 2- and 3-series plug-in units in both the vertical and horizontal deflection systems. When used together with the Type 230 Digital Unit, digital readout of measurements (in addition to the analog display on the CRT) makes the measurements faster, more convenient, and more accurate.

Connectors on the rear provide measurement information for the Type 230 Digital Unit and couple trace-brightening information from the Type 230 to the Type 568.

The Types 568/R568 are designed mainly for use in digital measurement systems, but they are also quite useful in laboratory applications through use of amplifier, spectrum analysis, and time-base plug-in units.

Through use of solid state components, the Types 568/R568 offer reliable operation with low heat dissipation.

Both cabinet-style Type 568 and rack-mount Type R568 use the same mechanical construction. A quick conversion from one style to the other is possible by means of a few mechanical changes. The R568 requires only 7 inches of rack height and is constructed for convenient stacking with the Type R230 Digital Unit.

CHARACTERISTIC SUMMARY

VERTICAL

Vertical deflection characteristics are extremely flexible through use of 2-series and 3-series Amplifier Plug-In Units. See chart for plug-in units that provide digital readout when used with a Type 230 Digital Unit.

HORIZONTAL

Horizontal deflection characteristics are extremely flexible through use of 2-Series and 3-Series Amplifier and Time-Base Units. See chart for plug-in units that provide digital readout when used with a Type 230 Digital Unit.

CRT

DISPLAY AREA—8 x 10 div. (Each major div = 1 cm.)

ACCELERATING VOLTAGE—3.5 kV.

PHOSPHOR—P2.

OTHER

AMPLITUDE CALIBRATOR—5 V and 0.5 V into $\geq 100 \text{ k}\Omega$ or 500 mV and 50 mV into 50 Ω . Repetition rate is 20 kHz or 1 kHz.

POWER REQUIREMENTS—Quick-change line-voltage taps permit operation from 90 to 110 V, 104 to 126 V, 112 to 136 V; or 180 to 220 V, 208 to 252 V, 224 to 272 V. Line frequency is 48 to 66 Hz. Power consumption is 210 watts maximum.

DIGITAL READOUT COMBINATIONS

Digital and analog displays are simultaneously presented on the Type 568 Readout Oscilloscope and Type 230 Digital Unit. A Digital Readout Combination consists of a Type 568, Type 230, and any of the following combinations of amplifier and

time-base Plug-In Units. Other 2-Series and 3-Series Plug-In Units can be used for normal analog CRT display, but do not provide digital readout.

PLUG-IN UNITS						
VERTICAL				TIME BASE		
TYPE	MINIMUM DEFLECTION FACTOR	T _R	BANDWIDTH	TYPE	CALIBRATED SWEEP RANGE	
3S1	2 mV/div	350 ps	DC to 1 GHz	3T2	200 ps/div to 100 μs/div plus X10 magnifier	
3S2	2 mV/div			3T4*	Programmable 1 ns/div to 200 μs/div	
S1		350 ps	DC to 1 GHz	3T77A	200 ps/div to 100 μs/div plus X10 magnifier	
S2		50 ps	DC to 7 GHz	3B2	2 μs/div to 1 s/div	
3S3	5 mV/div	350 ps	DC to 1 GHz			
3A2	10 mV/div	700 ns	DC to 500 kHz			

*Type 3T4, when used with Type 283 Real Time Adapter has an additional range of CALIBRATED SWEEP from 1 ms/div to 1 s/div, but no TIME POSITION in "REAL TIME" operation. Type 3T4 can also be programmed through a front panel connector. (See Type 3T4 catalog page.)

AMPLITUDE CALIBRATOR

Front-panel selection of squarewave outputs, of 20 kHz, crystal-controlled, with an accuracy of ±0.05% or approx 1 kHz, RC time-constant controlled. Output voltages are 5 V and 0.5 V into 1 MΩ or greater or 500 mV and 50 mV into 50 Ω. + PRETRIGGER output provides a positive-going pulse that occurs ≈ 1/4 cycle ahead of the rising portion of the calibrator signal. Connectors are BNC.

TEKTRONIX CRT

5-inch rectangular CRT with 3.5-kV accelerating potential. A P2 phosphor is normally supplied.

ILLUMINATED INTERNAL GRATICULE

Edge lighted graticule is marked in 8 vertical and 10 horizontal divisions (centimeters). Centerlines are also marked in 2-mm increments. Scale illumination is adjustable with a front-panel control.

DC-VOLTAGE SUPPLIES

Electronically regulated to compensate for widely varying line conditions. Separate regulated heater supply is included. The Type 568 has an additional 25 watts of regulated power available at the rear connector for system use.

POWER REQUIREMENTS

Quick-change line-voltage selection permits operation from any of the following line voltages:

90 V to 110 V	180 V to 220 V
104 V to 126 V	208 V to 252 V
112 V to 136 V	224 V to 272 V

The Type 568 will operate over a line frequency from 48 to 66 Hz, and its power consumption is 210 watts maximum.

TYPE 568 DIMENSIONS AND WEIGHTS

Height	8 in	20.3 cm
Width	16 13/16 in	42.7 cm
Depth	21 7/8 in	55.5 cm
Net weight	40 lb	18.2 kg
Domestic shipping weight	≈52 lb	≈23.6 kg
Export-packed weight	≈72 lb	≈32.7 kg

TYPE R568 DIMENSIONS AND WEIGHTS

Height	7 in	17.8 cm
Width	19 in	48.3 cm

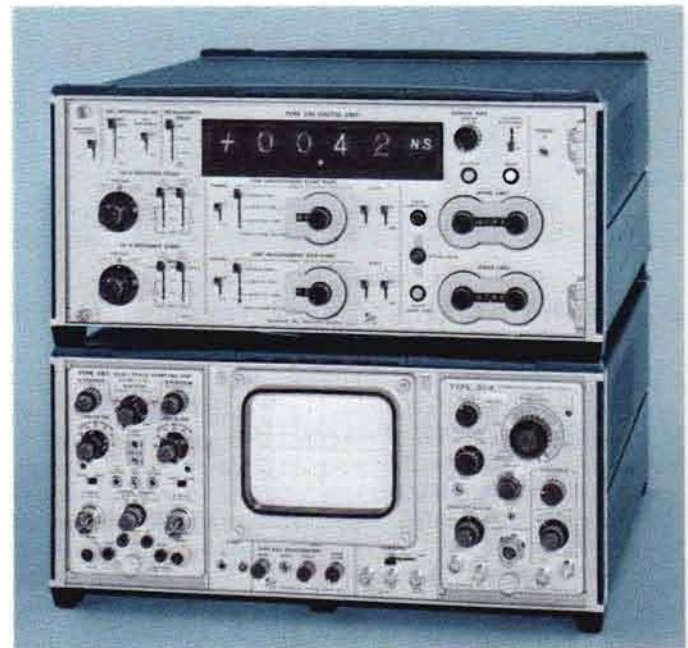

Rack depth	22 3/4 in	57.8 cm
Net weight	41 lb	18.6 kg
Domestic shipping weight	≈56 lb	≈25.5 kg
Export-packed weight	≈76 lb	≈34.5 kg

INCLUDED STANDARD ACCESSORIES

3 to 2-wire adapter (103-0013-00); CRT protector plate (387-0935-00); 18-inch patch cord, BNC-to-BNC (012-0087-00); 18-inch patch cord, BNC-to-banana plug (012-0091-00); patch cord, post jack-to-BNC (012-0092-00); two instruction manuals (070-0596-00). Type R568 also includes mounting tracks (351-0085-00) and mounting hardware.

Please refer to Terms and Shipment, General Information page.

TYPE 230 R230

DIGITAL UNIT

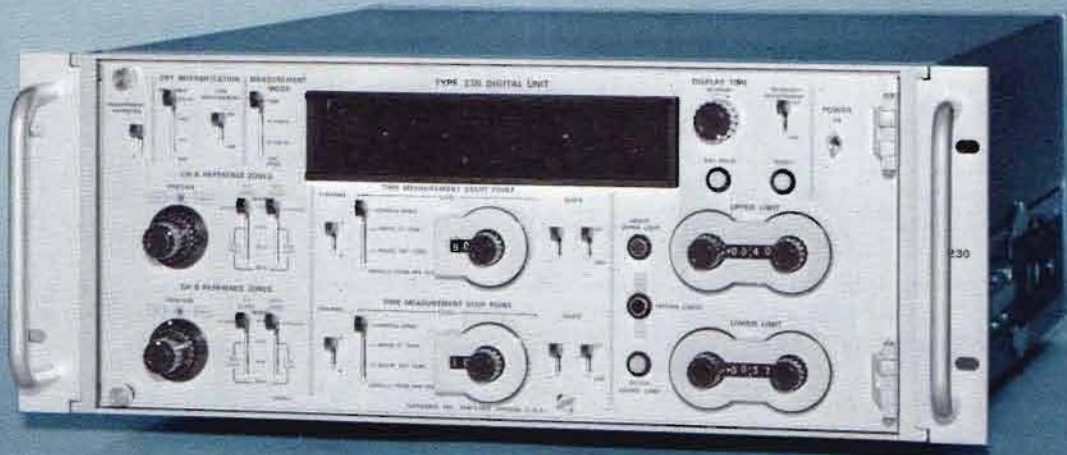

- PRESENTS OSCILLOSCOPE MEASUREMENTS

- IN DIGITAL FORM

- DIGITAL READOUT PARAMETERS

- PULSE AMPLITUDE
 - PULSE RISE AND FALL TIME
 - PULSE WIDTH
 - TIME INTERVAL

- UP TO 50 MEASUREMENTS PER SECOND

- PARALLEL GROUND-CLOSURE BCD PROGRAMMING

- BCD DATA OUTPUT (1 2 4 8)

- ALL SOLID STATE—EXTENSIVE USE OF INTEGRATED CIRCUITS

The Type 230 and Type R230 Digital Units are new high-speed solid-state units that provide digital measurements of signals displayed on the Type 568 Oscilloscope. The Type 230 has flexible measurement capabilities with up to 50 measurements per second, easy programming, BCD data outputs, and solid-state circuitry with extensive use of integrated circuits. The Type 230 Digital Unit can make a wide variety of repetitive pulse measurements on the signals displayed on the Type 568. The digital presentations can designate voltage measurements, time-difference measurements between similar pulses, and time-difference measurements between percentages or voltages of pulse amplitudes. The Type 230 can be externally programmed for use in high-speed automatic measurement systems and data output connectors provide measurement results in convenient BCD code.

MEASUREMENT MODES

The Type 230 Digital Unit's four basic measurement functions (Channel A volts, Channel B volts, Time, and External Program) are selected by the Measurement Mode switch.

VOLTAGE measurements are made on either Channel A or Channel B between the 0% and the 100% reference zones. The signal polarity is determined and read out automatically on the digital readout.

TIME measurements are made on either Channel A, Channel B or between the two channels. The time measurements are made from a pre-determined start point to a pre-determined stop point that can be referenced to the 0% and 100% reference zones or to the start of the sweep.

EXTERNAL PROGRAM: All of the front-panel functions required to make voltage and time measurements can be easily programmed externally. The variety and flexibility of measurements possible with external programming are even greater than those possible through use of the Type 230 front-panel controls, and measurements and limits can be changed more rapidly.

DIGITAL READOUT

The measurements made by the Type 230 are read out directly on four Nixie* tubes. Decimal point and unit of measure (ns, μ s, ms, s, mV, V) are automatically presented. The polarity of the measurement (+ or -) is also read out automatically.

DISPLAY TIME

The digital readout display time may be varied from ≈ 10 ms to 10 s. **EXTERNAL HOLD** light indicates when the measured data is being held until the recording device has had sufficient time to record the measurement. External hold does not prevent the next measurement from being made. In **TRIGGERED MEASUREMENT** operation, a measurement is started after a receipt of a trigger (+ or -) and after **DISPLAY TIME** has been completed. The **READY** light indicates a ready condition for a trigger.

REFERENCE ZONES

To make any digital voltage or time measurement of the waveforms displayed on the Type 568 Oscilloscope, the Reference Zones must be properly set. The 0% and the 100% zones establish the reference points from which all measurements are made. The reference zones can be brightened on the oscilloscope by means of the CRT Intensification Reference Zone switch. The switch brightens both zones, 100% zone only, 0% zone only or disables the zone intensification.

CHANNEL A REFERENCE ZONE

The 0% **POSITION** and 100% **POSITION** controls determine the start position of the 0% and 100% zones to any $\frac{1}{2}$ -cm point from the start of the sweep by means of a 20-position switch. Five external program lines are required for each position control.

LEVEL WIDTH controls select the width of the reference zone and select the type of voltage reading, average or peak.

The **AVERAGE 0.3-cm WIDTH** position of the control is normally used for average voltage and most time measurements.

*Trade-Mark Burroughs Corporation

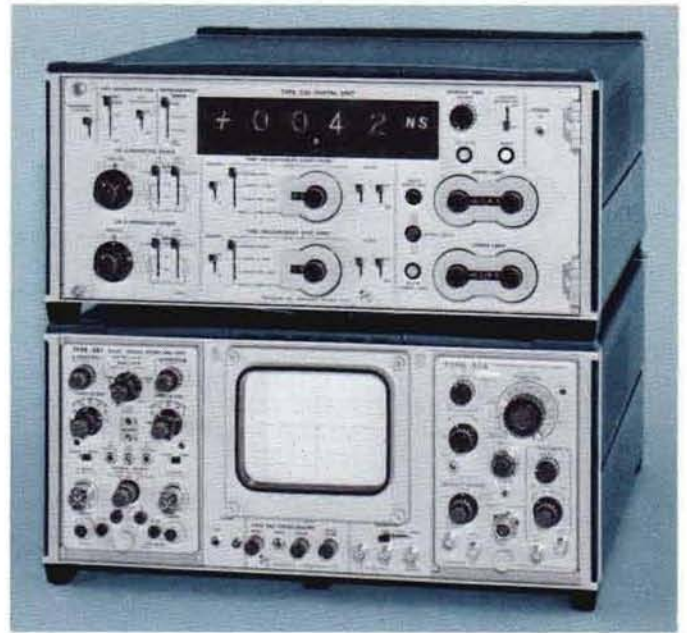

The three **PEAK** positions (2-cm, 4-cm, 10-cm **WIDTH**) are used for average to peak, or peak to peak voltage measurements. Two program lines are required for each 0% **LEVEL** or 100% **LEVEL** width controls.

CH B REFERENCE ZONES are identical in function and operation as Ch A Reference Zones except they are set on Ch B display.

TIME MEASUREMENT START POINT

The start of the time measurement is selected to start on either Channel A or Channel B and on the first or second positive-going or negative-going slope. The time measurement starts when the signal reaches one of the 99 pre-determined levels. Four different modes of start point level selection are available: (1) % between 0% and 100% zones, (2) mm above 0% zone, (3) mm below 100% zone, and (4) Horizontal mm from sweep start. Eleven BCD program lines are required for externally programming the time measurement start point. There are 159 pre-determined levels available in the external programming mode.

CRT intensification during the time measurement portion of the sweep is selected by means of the CRT Intensification Time Measurement On-Off switch.

TIME MEASUREMENT STOP POINT

All functions of the Time Measurement Stop Point are identical to the previously explained Time Measurement Start Point. It stops the count on the selected point on Ch A or Ch B. If the Stop Point occurs before the Start Point, a negative reading is indicated.

LIMIT CONTROLS

The Limit Controls select the **UPPER** and **LOWER** measurement Limits. Measurement limit results can be quickly determined on the front-panel by means of three lights (**ABOVE UPPER LIMIT**, **WITHIN LIMITS**, **BELOW LOWER LIMIT**) and the information is available on the rear panel for stopping automatic measurement sequences or for automatic sorting. Fifteen BCD lines are required for programming each limit control.

RESOLUTION

DOTS/MEASUREMENT Time measurements are performed by gating and counting clock-pulses during the measurement interval. If a measurement interval occupied 2.5 div and the sweep speed was 10 ns/div with 100 samples/div, then 250 samples would be registered in the digital readout counter and reading would be 25.0-ns. For sweep speeds with multipliers of 2, the count is doubled and the decimal is shifted to maintain maximum resolution. For multiples of 5 the count is divided by 2 providing 50 samples/div.

The **TIME MEASUREMENT START** and **STOP** comparators have ± 0.1 mm pick-off resolution capabilities. This gives the Type 230 the ability to scale a 1-cm display in 1% steps.

MEASUREMENT AVERAGING permits selection of measurements to be a statistical average of eight sweeps or to be a measurement of only one sweep. One program line is required for Measurement Averaging selection.

EXTERNAL READOUT

Data outputs are available on the rear-panel of the Type 230 that permit the recording of measurement polarity, displayed digits, units of measure, decimal point, and measurement limit results. The information is in BCD code (1 2 4 8; true . . . ground, false . . . +12 Volts) and the Type 230 can be synchronized to the data recorder.

Regulated power is available for use in systems applications.

EXTERNAL PROGRAMMING

The Type 230 Digital Unit is designed to be externally programmed for use in high-speed measurement systems, up to 100 measurements per second with proper programming techniques. All of its measurement functions can be programmed by means of ground closures or logic levels. The programming is achieved with 104 program lines using negative logic with true being ground or $< 2V$ and false being open or $> 6V$. Suitable programming devices include card readers, block readers, computers, etc.

HIGH SPEED PROGRAMMED MEASUREMENTS

When using the Type 3T4 Programmable Sampling Sweep for the oscilloscope time base, the Type 230 Digital Unit can program the Type 3T4 to provide increased measurement speeds. The time-base can be made to run fast (10 dots/div) during the non-measurement part of the sweep and then run

at normal speeds (100 dots/div) for maximum resolution during the measurement. The Type 3T4 is also set for Single-Sweep operation and the sweep is started by the Type 230 so that no time is lost waiting for an unwanted sweep to finish. This function is obtained by externally programming the high speed program line.

Measurement speed can be increased by externally programming the position of the 0% and/or 100% Reference Zones start point to 12 cm. This puts the reference zones into a memory hold position of up to 10 seconds and permits several different measurements to be made without a zone charging sweep. This gives an additional feature of permitting measurements referenced to reference zones that are not on the CRT display.

OTHER CHARACTERISTICS

POWER REQUIREMENTS

90 to 136 VAC or 180 to 272 VAC, 48 to 66 Hz, 130 watts maximum at 115 V and 60 Hz. Rear panel selector provides rapid accommodations for six line-voltage ranges.

TYPE 230 DIMENSIONS AND WEIGHTS

Height	8 in	20.3 cm
Width	16 ¹³ / ₁₆ in	42.7 cm
Depth	21 ⁷ / ₈ in	55.5 cm
Net weight	38 lb	17.3 kg
Domestic shipping* weight	≈50 lb	≈22.7 kg
Export-packed weight	≈73 lb	≈33.2 kg

TYPE R230 DIMENSIONS AND WEIGHTS

Height	7 in	17.8 cm
Width	19 in	48.3 cm
Depth	22 ³ / ₄ in	57.8 cm
Net weight	40 lb	18.2 kg
Domestic shipping weight	≈52 lb	≈23.6 kg
Export-packed weight	≈75 lb	≈34.1 kg

INCLUDED STANDARD ACCESSORIES

Type 230 to Type 568 48-inch interconnecting cable (012-0119-00); 3 to 2-wire adapter (103-0013-00); two instruction manuals (070-0635-00). Type R230 also includes mounting tracks (351-0085-00) and mounting hardware.

Please refer to Terms and Shipment, General Information page.

TYPICAL AUTOMATIC MEASUREMENT SYSTEM

(For further information, consult your Field Engineer)

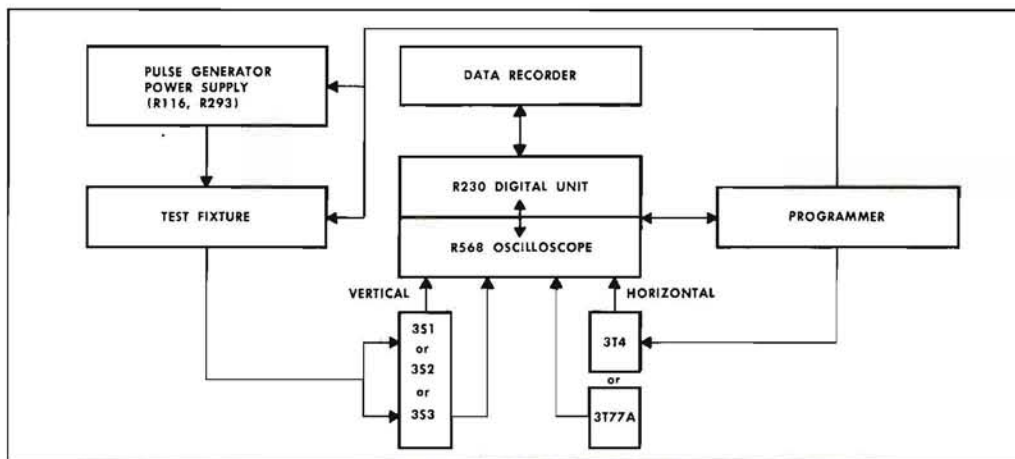

TYPE S-3100

Programmable Measurement System

NEW



- >100 MEASUREMENTS PER SECOND
- PROGRAMMABLE SUB-NANOSECOND MEASUREMENTS
- PROGRAMMABLE VERTICAL AMPLIFIER UNIT
- PROGRAMMABLE TIME-BASE UNIT
- PARALLEL PROGRAMMING
- REAR-PANEL INPUT SIGNAL CONNECTORS
- PARALLEL BCD DATA OUTPUT (1 2 4 8)
- AVAILABLE OPTIONS:
 - PROGRAMMABLE SELF-CALIBRATION ($\pm 1\%$)
 - PROBE REFERENCE CHOPPERS
 - REAL-TIME MEASUREMENT CAPABILITY

The Tektronix Type S-3100 is a high-speed programmable system designed to satisfy dynamic switching time measurements. It features digital programming, measurement speeds greater than 100 measurements per second, and programmable vertical and horizontal sampling units.

The system is comprised of a special Type 568 Oscilloscope, Type 230 Digital Unit, an Auxiliary Unit, a special programmable sampling time-base and special programmable sampling vertical units, with either a 50- Ω input or a 100-k Ω , 2-pF input.

TYPE S-3100

The Type S-3100 measurement system is designed to be externally programmed for use in high-speed measurement systems. All of its measurement functions can be programmed by means of parallel ground closures or logic levels. The programming is achieved with a maximum of 175 program lines (145 lines without self-calibration) using negative logic (true equals ground or less than 1 V, and false equals open or greater than 6 V).

The typical accuracy of the Type S-3100 is within 3%. A self-calibration option is available (ordered with the Type S-3100) that can be programmed to verify and/or adjust sweep rates and vertical deflection factors to within 1%. Other optional accessories available with the Type S-3100 system include programmable probe attenuators, probe choppers for absolute voltage measurements, and the R283 Real-Time Adapter that extends the system's measurement capabilities to 1 s/div.

WIDE RANGE OF MEASUREMENT CAPABILITY

Type S-3100 Digital System measures nanosecond and microsecond signals by means of equivalent-time sampling; millisecond and slower signals by real-time sampling.

Measurement rates greater than 100 measurements/second are achieved when using equivalent sweep rates of 100 ns/div or faster, and through the use of programming techniques designed to optimize the measurement rates. Measurement rates can be dependent upon programming devices. For example, some mechanical programmers are limited to approximately 4 measurements per second. While using a computer, or other high-speed programming device, the Type S-3100 can make in excess of 100 measurements per second.

At slower equivalent sweep rates, measurement rates decrease because of sampling limitations. However, measurement rates at all sweep rates are significantly increased as a result of improved measurement and sampling techniques.

The system can be programmed to make sampling measurements from 1 ns/div to 200 μ s/div (10 ns to 2 ms full scale). If slower sweep rates are required, the optional Type R283 Real-Time Adapter can be integrated into the system, thereby extending the system's capability to 1 s/div.

Amplitude measurements from 5 mV/div to 100 mV/div (40 to 800 mV full scale) are also programmable.

TYPICAL MEASUREMENTS

Typical measurements include risetime, delay time, storage time, fall time, pulse width, pulse amplitude and other specific time and voltage measurements. With the probe-chopper option, the system can make DC and/or pulse voltage measurements with respect to ground.

TYPE R568 OSCILLOSCOPE

The Type R568 Oscilloscope used in the Type S-3100 System has vertical signal inputs and trigger signal inputs on the rear panel. The oscilloscope provides analog displays of signals to be measured by the digital system and is used in setting up measurement programs and in verifying measurements.

TYPE R230 DIGITAL UNIT

The Type R230 Digital Unit used in the Type S-3100 System is modified to provide increased measurement speeds when used with the special programmable sampling time-base unit. This modification resets the time-base unit at the end of the measurement or at the end of the reference zone. This feature permits the increased measurement speed of the Type S-3100.

PROGRAMMING

All of the Type 230's measurement functions can be programmed by means of ground closures or logic levels. The programming is achieved with 104 parallel program lines using negative logic (true = gnd or <2 V; false = open or >6 V).

DATA OUTPUT

Data outputs available on the rear-panel of the Type 230 permit the recording of measurement polarity, displayed digits, units of measure, decimal point, and measurement limit results. The information is parallel BCD code (1 2 4 8; true = ground; false = +12 Volts).

PROGRAMMABLE TIME-BASE UNIT

The programmable sampling time-base has calibrated and programmable sweep ranges from 1 ns/div to 200 μ s/div in a 1-2-5 sequence. It accepts trigger signal inputs via a rear connector on the Type 568. A measurement speed-up modification allows the Type 230 to reset the sweep at the end of the measurement or at the end of the reference zone.

PROGRAMMING

The Auxiliary Unit provides common programming logic for programming the time/div range and a digital to analog converter for programming the delay time control. The sweep range requires 5 program lines with negative logic.

Delay time is programmed with 12 lines and provides from 1 through 999 steps in 1-ns steps (1-ns/div to 100-ns/div range); 100-ns steps (200-ns/div to 10- μ s/div range); 1- μ s steps (20- μ s/div to 100- μ s/div range).

Samples per sweep can be programmed to provide 100 samples/div or 10 samples/div. The Type 230 Digital Unit can program the time-base unit to sweep at 10 samples/div during the non-measurement part of the sweep and then switch to 100 samples/div for maximum resolution during measurement time.

PROGRAMMABLE DUAL-TRACE VERTICAL AMPLIFIER UNITS

Two programmable dual-trace vertical sampling units are available offering you a choice of input impedance and risetime capabilities. The sampling probe unit with the P6038 sampling probes has 100 k Ω paralleled by 2-pF input impedance and a 350-ps risetime. The 50- Ω input impedance unit has a 450-ps risetime.

The vertical amplifier units accept signal inputs via rear connectors on the Type 568 Oscilloscope, and have programmable mV/div and programmable DC offset. The vertical deflection factor range of both amplifier units is 5 mV/div to 100 mV/div.

PROGRAMMING

The Auxiliary Unit provides two digital to analog converters for programming the DC offset. DC offset is programmed with 7 program lines, (50- Ω vertical amplifier — 10 mV to 850 mV range in 10-mV steps; 100-k Ω vertical amplifier — 5 mV to 455 mV range in 5-mV steps) and one line for + or - DC offset. The mV/div range is programmed with 6 program lines, 3 lines per channel.

AUXILIARY UNIT

The Auxiliary Unit is an integral part of the Type S-3100 Programmable Measurement System. The Auxiliary Unit provides common negative logic for the time-base unit and the optional Type R283 Real-Time Adapter and provides digital to analog converters for DC offset and time delay. The Auxiliary Unit also provides the power supplies and accepts the circuit cards for the optional self-calibration feature.

MECHANICAL CHARACTERISTICS

The three instruments in the Type S-3100 System have identical dimensions of 7 in high by 19 in wide by 22 $\frac{3}{4}$ in deep, providing a system height of 21 inches. They mount in a standard 19-inch rack on slideout tracks, and can be pulled out, tilted and locked in any one of seven positions for convenient access.

TYPE S-3100 SYSTEM

Includes a modified Type R568 Oscilloscope, Type R230 Digital Unit, an Auxiliary Unit, a special programmable time-base and a programmable vertical amplifier unit (specify 50- Ω input or 100-k Ω , 2-pF input).

TYPICAL AUTOMATIC MEASUREMENT SYSTEM

(For further information, consult your Field Engineer)

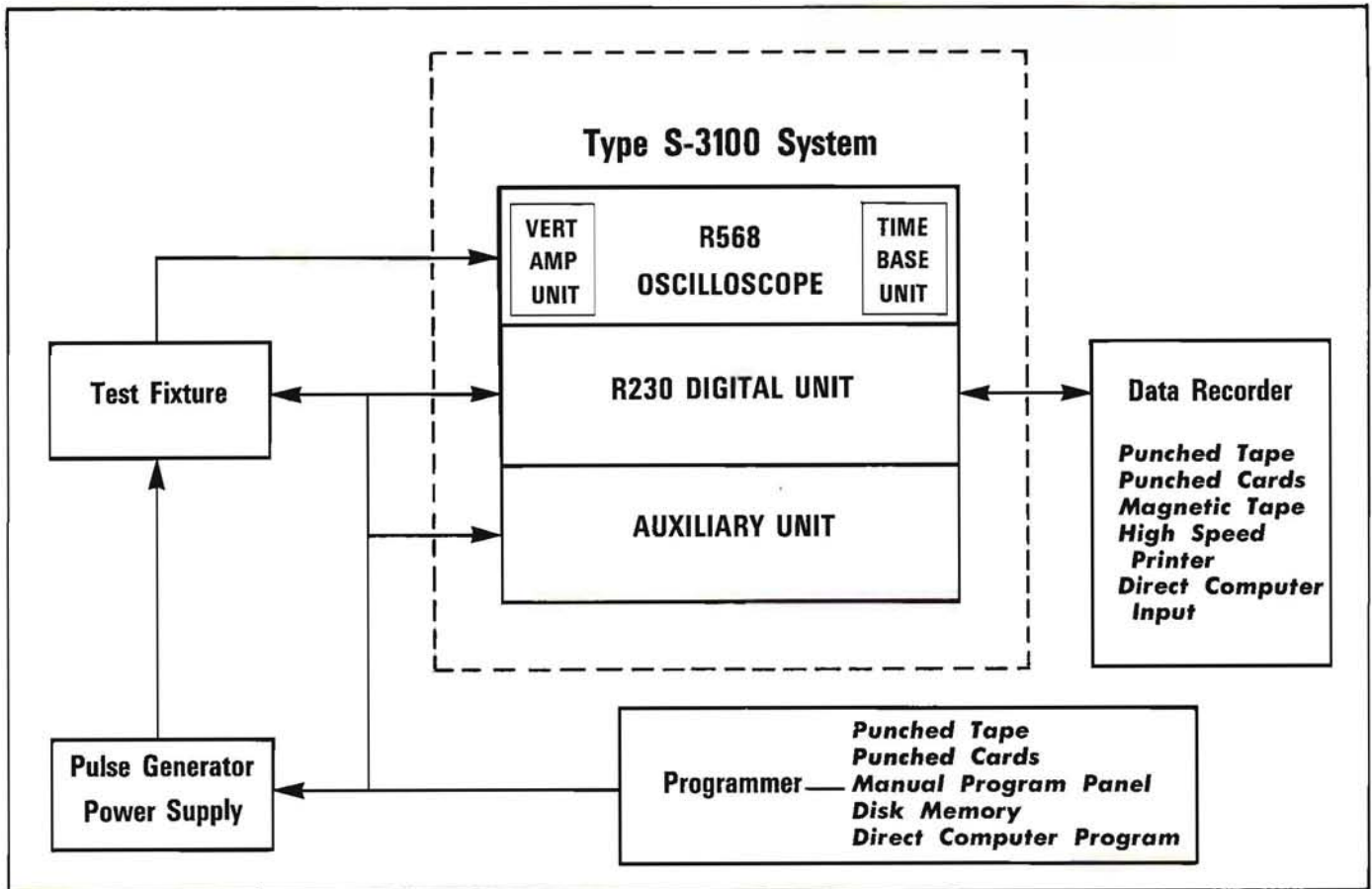

TYPE S-3100

OPTIONS

(Available with the Type S-3100 System)

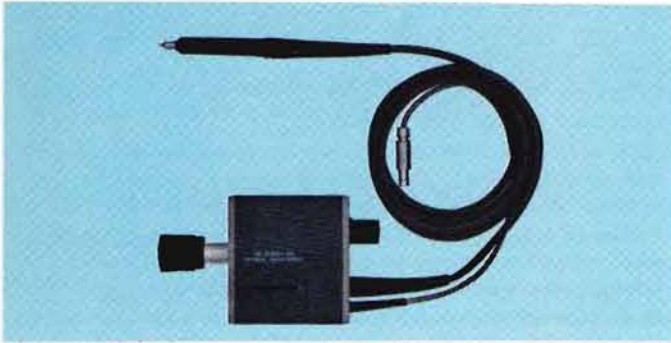

P6045 FET PROBE

The P6045 FET Probe when used with the 50- Ω vertical probe provides a risetime of less than 2 ns with an input resistance of 10 M Ω and a gain of 1. The input capacitance is approximately 5.5 pF and probe attenuators of X10 and X100 are provided. Accessory Power Supply included. Order 010-0205-00

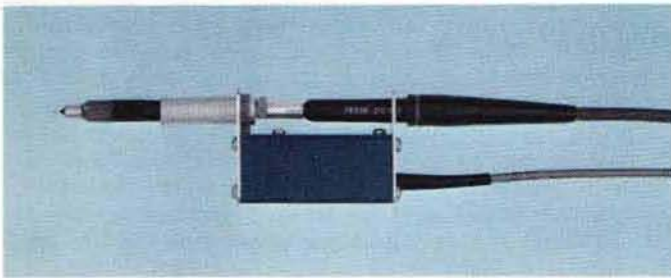

PROBE CHOPPERS

Probe choppers are available for the P6045 probe or P6038 sampling probe. With the probe chopper option, the Type S-3100 System can make DC and pulse voltage measurements with respect to ground.

Probe Chopper for P6038, order 119-0159-00

Probe Chopper for P6045, order 119-0160-00

SELF-CALIBRATION

The self-calibration option checks and adjusts, when necessary, the vertical deflection factor and horizontal sweep rates to within 1%.* This option adds cards to the auxiliary unit and modifies the vertical and horizontal units to permit automatic adjustment of the vertical deflection factor and the horizontal sweep rates. Order 018-0010-00

(Available only when ordering S-3100)

*Accuracy of the 1 ns/div, 5 mV/div and 10 mV/div positions are within 3%, 5% and 2% respectively.

REAL-TIME ADAPTER

If sweep rates slower than 200 μ s/cm are required, a Real-Time Adapter can be added to the system, thereby extending its measurement capabilities from 1 ms/div to 1 s/div (10 s full scale). An interface card in the Auxiliary Unit converts the program logic from positive logic to the standard Type S-3100's negative logic.

Order Type R283 MOD 646A

Please refer to Terms and Shipment, General Information page.

PROGRAMMING UNITS

Equipment designed for programming the S-3100 is available from Tektronix. These include a program panel which provides up to five measurements and an optical punched tape reader with a serial to parallel converter.

PROGRAM PANEL

This unit provides five separate measurement programs which can be automatically sequenced or manually selected by the operator. The operator or technician prepares a program by inserting pins at the appropriate points for the measurement parameters desired. Typically, only thirty lines of the 160 program lines need to be changed for a given measurement. The program panel may be set up to stop the measurement sequence on out-of-limits results.

OPTICAL PUNCHED-TAPE READER

The optical punched-tape reader provides a means of obtaining a greater number of programmed measurements, limited only by the length of the tape used. The serial to parallel converter changes the punched tape output to the parallel program format required by the S-3100 system. The measurement rate of the S-3100 system is determined by the optical tape reader. This can be as high as twenty measurements per second.

For complete information, including price and availability, contact your local Tektronix Field Engineer.

TYPE 3A2

DUAL-TRACE ANALOG/ DIGITAL AMPLIFIER UNIT



The Type 3A2 Dual-Trace Amplifier and Type 3B2 Time-Base Units enable digital readout and analog displays of low and medium-frequency information. Both types of displays are provided using the Type 567 Oscilloscope (with Type 6R1A) or Type 568 Oscilloscope (with Type 230). Analog displays (but not digital readout) are provided using Type 561A or 564 Oscilloscopes. The Type 3A2 also provides analog displays in the Type 565 Oscilloscope.

TYPE 3A2 DUAL-TRACE AMPLIFIER UNIT

BANDWIDTH

DC to 500 kHz at 3-dB down. Low-frequency 3-dB point AC-coupled: 2 Hz.

DEFLECTION FACTOR

10 mV/div to 10 V/div in 10 calibrated steps (1-2-5 sequence), accurate within 3%. Uncalibrated, continuously variable between steps and to approx 25 V/div.

INPUT RC

1 megohm paralleled by approx 47 pF.

MAXIMUM INPUT VOLTAGE

600 V (DC + peak AC).

OPERATING MODES

Either single channel, normal or inverted; algebraic addition; chopped or alternate electronic switching between channels. Alternate: channels switched at the end of each sweep. Chopped: successive 12- μ s segments of each channel displayed at an approx 40-kHz rate per channel. Chopped transient blanking is provided.

TRIGGER SOURCE

Channel 1, Channel 2, or displayed signal.

TYPE 3B2

ANALOG/DIGITAL TIME BASE UNIT



TYPE 3B2 TIME-BASE UNIT

TIME BASE

2 μ s/div to 1 s/div in 18 calibrated steps (1-2-5 sequence), accurate within 3%. Calibrated digital readout available throughout full time base with Types 568 and 230, from 20 μ s/div to 1 s/div with Types 567 and 6R1A.

DIGITAL RESOLUTION

0.1 μ s to 10 ms in 6 decade steps with Types 568 and 230; 1 μ s to 10 ms in 5 decade steps with Types 567 and 6R1A. Resolution can be selected independently of time/div, to increase digital readout accuracy when the first significant digit is known. Front panel indicates maximum resolution (without possible counter overflow) that can be attained for each time/div setting. Clock accuracy is 0.1%.

DELAY TIME

5 μ s to 10.5 s, continuously variable and calibrated, accurate within 1%. Delay can be switched in or out.

SIGNAL OUTPUTS

Delayed trigger nominally +5 V, sweep gate nominally +15 V.

TRIGGER COUPLING

AC Slow, AC Fast, or DC.

TRIGGER SOURCES

Internal, external, or line.

TRIGGER REQUIREMENTS

0.2-cm deflection or 0.4 V external. ± 12 -V trigger level selection.

Please refer to Terms and Shipment, General Information page.



The Type 3S1 Sampling Unit is a dual-trace amplifier with internal delay lines and trigger takeoffs. It has two separate channels with identical characteristics; operates in any of five modes for a variety of single, dual-trace and X-Y displays. It is designed to operate with a Type 3T2, Type 3T4 or Type 3T77A Sampling Sweep Unit in Type 561A, 564, 567 and 568 Oscilloscopes. In the Type 567 (with Type 6R1A) or 568 (with Type 230), information will be presented in digital as well as analog form.

RISETIME

350 ps or less.

BANDWIDTH

Equivalent to DC to 1 GHz at 3-dB down.

DEFLECTION FACTOR

2 mV/div to 200 mV/div in 7 calibrated steps, 1-2-5 sequence.

INPUT CHARACTERISTICS

50 ohms. GR 874 input connectors. Safe overload is ± 5 V.

DC OFFSET RANGE

+1 V to -1 V. Allows signals between +1 V and -1 V limits to be displayed at 2 mV/div. Signals between +2 V and -2 V limits may be displayed at 200 mV/div. Monitor jacks provide 10X actual DC offset through 10 k Ω .

TRIGGER SOURCE

Selects built-in trigger takeoff signal from either channel.

SIGNAL DELAY

Internal delay line for each channel.



The Type 3S3 Sampling-Probe Unit is a low-noise dual-trace amplifier employing extremely compact sampling probes. It has two separate channels with identical characteristics; operates in any of five modes for a variety of single, dual-trace and X-Y displays. The Type 3S3 is designed to operate with a Type 3T2, 3T77A or Type 3T4 Sampling Sweep Unit in the Type 561A, 564, 567, or 568 Oscilloscopes. In the Type 567 (with Type 6R1A) or Type 568 (with Type 230), information can be presented in digital as well as analog form.

RISETIME

350 ps or less (FAST RT) or approx 800 ps (LOW NOISE).

BANDWIDTH

Equivalent to DC to 1 GHz.

DEFLECTION FACTOR

5 mV/div to 100 mV/div in 5 calibrated steps, 1-2-5 sequence.

INPUT CHARACTERISTICS

100 k Ω paralleled by 2 pF. Safe overload is ± 10 V.

DC OFFSET RANGE

+0.5 V to -0.5 V. Allows signals between +0.5 V and -0.5 V limits to be displayed at 5 mV/div. Signals between +1 V to -1 V limits may be displayed at 100 mV/div.

TRIGGER SOURCE

External only.

Please refer to Terms and Shipment, General Information page.

SEE PAGE 187 FOR FURTHER INFORMATION

SEE PAGE 190 FOR FURTHER INFORMATION

NEW

- **PLUG-IN SAMPLING HEADS**
Type S1, 350-ps risetime, low noise
Type S2, 50-ps risetime
- **2 mV/DIV TO 200 mV/DIV DEFLECTION FACTOR**
- **VARIABLE INTER-CHANNEL DELAY**
- **NEW PERFORMANCE WITH RANDOM SAMPLING**

The Type 3S2 Dual-Trace Sampling Unit is designed for use in the Type 561A, 564, 567 or 568 Oscilloscope. The unit can be used with sampling sweep units, including the Type 3T2 Random Sampling Sweep, or with real-time time base units to allow sweep rates to 5 s/div.

The Type 3S2 accepts two sampling heads that can be inserted directly or located remotely with an optional extender.

Plug-In sampling heads (choice of fast-risetime or low-noise) are available for applications requiring two identical channels, or a combination of fast-risetime and low-noise channels. A front-panel control allows adjustment of the inter-channel time relationship to compensate for signal cables or other external delays. Five display modes provide for a variety of single-trace, dual-trace or X-Y displays. The 3S2 can also be operated with only one head, for applications not presently requiring dual-trace displays.

CHARACTERISTICS

SAMPLING HEADS

Accepts Type S1 or S2 Sampling Heads. (See next page for characteristics).

DEFLECTION FACTOR

2 mV/div to 200 mV/div in 7 calibrated steps, 1-2-5 sequence. Each step accurate within 3%. Variable between steps, extending to approximately 0.8 mV/cm, uncalibrated.

DC OFFSET RANGE

+1 V to -1 V. Allows signals between 1 V and -1 V limits to be displayed at 2 mV/div. Signals between +2 V and -2 V limits can be displayed at 200 mV/div. Monitor jacks provide 10X actual DC offset through 10 k Ω .

TRIGGERING

Trigger pickoff within sampling heads permits triggering on either input signal. 50- Ω Trigger Out connector at the front panel delivers approximately 10% of the input signal amplitude to the 50- Ω External Trigger Input of the sweep unit.

B-DELAY RANGE

Channel B display can be continuously positioned in time from +5 ns to -5 ns with respect to Channel A. Accommodates 3 feet difference in signal or sampling-head cables.

DUAL-TRACE SAMPLING UNIT

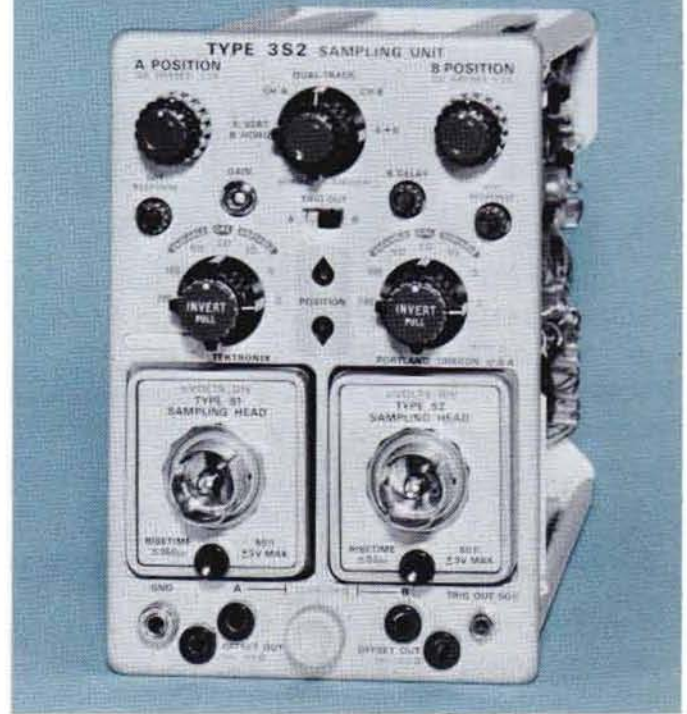

DISPLAY MODES

A only, B only, Dual Trace, Algebraic Addition of A and B signals, and X-Y display of A-vertically and B-horizontally, (for observation of hysteresis loops, phase shift, and similar displays). Independent controls for each channel permit positioning and inverting displays as desired.

VERTICAL OUTPUT

200 mV for each division of displayed signal through 10 k Ω .

WEIGHTS

Net weight	5½ lb	2.5 kg
Domestic shipping weight	≈ 8½ lb	≈ 3.9 kg
Export-packed weight	≈ 12 lb	≈ 5.5 kg

INCLUDED STANDARD ACCESSORIES

7-inch trigger cable with RG58 BNC/BSM connectors (012-0128-00); 18-inch trigger cable with RG58 BNC/BSM connectors (012-0127-00); two instruction manuals (070-0759-00).

OPTIONAL ACCESSORIES

3-ft sampling-head extender, order 012-0124-00

6-ft sampling-head extender, order 012-0125-00

Please refer to Terms and Shipment, General Information page.

TYPE S-1

350-ps SAMPLING HEAD



- **350-ps SAMPLING HEAD**
- **DC-TO-1 GHz BANDWIDTH**
- **RANDOM NOISE LESS THAN 2 mV (unsmoothed)**

The Type S1 Sampling Head is a low-noise, 350-ps risetime unit with a 50-Ω input impedance. It is designed for use with the Type 3S2 Dual-Trace Sampling Unit and can be plugged into the Type 3S2 or attached by a cable for remote use. A trigger pickoff within the Type S1 provides a trigger signal output from the Type 3S2. When used with the Type 3T2 Random Sampling Sweep Unit, the triggering event may be displayed on the screen without the use of delay lines or a pre-trigger.

CHARACTERISTICS

RISETIME

Less than or equal to 350 ps.

BANDWIDTH

Equivalent to DC to 1 GHz at 3-dB down.

TRANSIENT RESPONSE

+0, -3% or less aberrations in first 5 ns following a step transition; ±0.5% or less after 5 ns (as observed with Type 284 Pulse Generator).

RANDOM NOISE

Equivalent to an input signal of 2 mV or less, unsmoothed; 1 mV, smoothed (tangentially measured).

SIGNAL RANGE

Variable DC offset allows signals between +1 V and -1 V limits to be displayed at 2 mV/div. Signals between +2 V and -2 V limits may be displayed at 200 mV/div. More than one sample is required to display 100% amplitude of signals greater than 500 mV P-P.

INPUT CHARACTERISTICS

Nominally 50 Ω. Safe overload is ±5 V. GR 874 input connectors.

WEIGHTS

Net weight	3/4 lb	0.34 kg
Domestic shipping weight	≈1 1/2 lb	≈0.68 kg

INCLUDED STANDARD ACCESSORIES

5-ns, RG58 cable with GR connectors (017-0512-00); 10X, 50 Ω, GR attenuator (017-0078-00); instruction manual (070-0763-00).

TYPE S-2

50-ps SAMPLING HEAD



- **50-ps SAMPLING HEAD**
- **DC-TO-7 GHz BANDWIDTH**
- **RANDOM NOISE LESS THAN 10 mV (unsmoothed)**

The Type S2 Sampling Head is a 50-ps risetime unit with a 50-Ω input impedance. It is designed for use with the Type 3S2 Dual-Trace Sampling Unit and can be plugged into the Type 3S2 or attached by a cable for remote use. A trigger pickoff within the Type S2 provides a trigger signal output from the Type 3S2. When used with the Type 3T2 Random Sampling Sweep Unit, the triggering event may be displayed on the screen without the use of delay lines or a pre-trigger.

CHARACTERISTICS

RISETIME

Less than or equal to 50 ps.

BANDWIDTH

Equivalent to DC to 7 GHz at 3-dB down.

TRANSIENT RESPONSE

±5% or less aberrations in first 500 ps following a step transition; ±2% or less after 500 ps (as observed with Type 284 Pulse Generator).

RANDOM NOISE

Equivalent to an input signal of 10 mV or less, unsmoothed; 5 mV, smoothed (tangentially measured).

SIGNAL RANGE

Variable DC offset allows signals between +1 V and -1 V limits to be displayed at 2 mV/div. Signals between +2 V and -2 V limits may be displayed at 200 mV/div. More than one sample is required to display 100% amplitude of signals greater than 200 mV P-P.

INPUT CHARACTERISTICS

Nominally 50 Ω. Safe overload is ±5 V. GR 874 input connectors.

WEIGHTS

Net weight	3/4 lb	0.34 kg
Domestic shipping weight	≈1 1/2 lb	≈0.68 kg

INCLUDED STANDARD ACCESSORIES

5-ns, RG213 cable with GR connectors (017-0502-00); 10X, 50-Ω, GR attenuator (017-0078-00); instruction manual (070-0764-00).

OPTIONAL ACCESSORIES

P6040/CT-1 Current Probe, order 015-0041-00

CT-3 Signal Pickoff, order 017-0061-00

VP-1 Voltage Pickoff, order 017-0073-00

P6034 10X Passive Probe, order 010-0110-00

P6035 100X Passive Probe, order 010-0111-00

Power Divider GR 874-TPD, order 017-0082-00

Coupling Capacitor, GR 874-K, order 017-0028-00

Please refer to Terms and Shipment, General Information page.

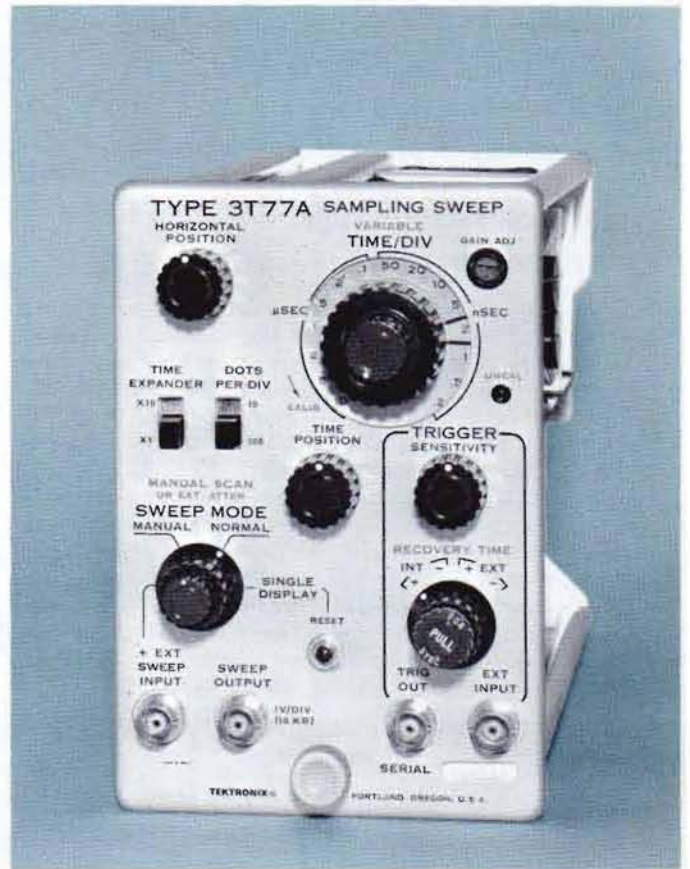

The Type 3T2 Random Sampling Sweep Unit provides a unique, state-of-the-art advancement in measurement capabilities. This unit may be used in a Type 561A, 564, 567, or 568 Oscilloscope, with a Vertical Dual-Trace Sampling Unit. In the Type 567 (with 6R1A) or 568 (with Type 230), information can be presented in digital as well as analog form. A front-panel switch selects either conventional sequentially-stepped sampling (for digital readout) or random sampling modes of operation.

Random sampling permits observation of the leading edge (or other portions) of signals even when used with vertical units that have no delay lines and without a pretrigger, thus avoiding the distortions or bandwidth-limiting effects of vertical signal delay lines. Random sampling is especially useful with sampling units such as the Type 3S2 and Type 3S3.

SWEET TIME/DIV

100 μ s/div to 200 ps/div, 1-2-5 sequence, extending to 20 ps/div with X10 DISPLAY MAGNIFIER. TIME/DIV is a resultant of the combined settings of TIME POSITION RANGE (100 ns to 1 ms), TIME MAGNIFIER (X1 to X50) and DISPLAY MAG (X1 or X10). TIME/DIV "window" provides digital readout for all combinations of these controls.

SAMPLES/DIV

Variable from approx 5 to an immeasurable number.

TRIGGER REPETITION RATE RANGE

10 Hz to 3 GHz (pulses); 10 kHz to 3 GHz (sinewaves). Separate 1 M Ω and 50 Ω external inputs.

The Type 3T77A is a Sampling Sweep Unit. It provides subnanosecond capabilities when used with a Type 3S1, 3S2 or 3S3 Sampling Unit in a Type 561A, 564, 567, or 568 Oscilloscope. In the Type 567 (with Type 6R1A) or 568 (with Type 230), information can be presented in digital as well as analog form.

SWEET TIME/DIV

10 μ s/div to 0.2 ns/div in 15 calibrated steps, 1-2-5 sequence, to 20 ps/div with TIME EXPANDER (samples/cm constant).

TIME POSITION

Provides a sweep delay range corresponding to at least one screen diameter, unexpanded, and at least ten screen diameters (100 div) when expanded.

TRIGGER REPETITION RATE RANGE

30 pulses per second (limited by memory drift in the vertical plug-in) through 10⁹ pulses per second (1 GHz); 100 kHz through 1 GHz sinewaves.

AMPLITUDE RANGE

\pm 10 mV to \pm 200 mV for external pulse triggering, 10 mV to 400 mV P to P for external sinewave triggering. Five times more trigger amplitude is required for equivalent internal triggering.

Please refer to Terms and Shipment, General Information page.

SEE PAGE 191 FOR FURTHER INFORMATION

SEE PAGE 193 FOR FURTHER INFORMATION

TYPE 3T4

PROGRAMMABLE SAMPLING SWEEP UNIT

- PROGRAMMABLE TIME/DIV
- PROGRAMMABLE DELAY
- 1 ns/DIV TO 200 μ s/DIV CALIBRATED SWEEP RANGE
- CALIBRATED SWEEP DELAY

The Type 3T4 Sampling Sweep Unit extends the convenience of operation of the Type 567 or 568 Digital Readout Systems by providing remote control of the horizontal time base. This unit is compatible with the following equipment: 3S1, 3S2, 3S3, and other 3-series Sampling Units; 561A, 564, 567, and 568 Indicator Units; 6R1A, and 230 Digital Units; the 262 Programmer; and the 283 Real Time Adapter.

The multiple-pin connector on the front panel, also available on the rear panel, affords external control of equivalent-time sweep steps, delay time, samples per sweep, normal or single-display modes, and single-display start. These operations are obtained through the grounding of certain pins of the front-panel connector. Delay time is determined by the value of resistors added externally. For real-time measurements, using the Type 283 Adapter, only TIME/DIV can be remotely controlled.

REMOTELY PROGRAMMABLE FUNCTIONS

- Equivalent-Time Sweep Ranges.
- Delay Time.
- Samples per Sweep.
- Normal or Single-Display Modes.
- Single-Display Start (when remotely programmed for SINGLE DISPLAY).

SWEEP TIME/DIV

- Equivalent-Time Sampling: 1 ns/div to 200 μ s/div in 17 calibrated steps, 1-2-5 sequence. Each step accurate within 3%. Variable between steps.
- Real-Time Sampling: 1 ms/div to 1 s/div. External clock, trigger, and single-display start inputs are required. See Type 283.

DISPLAY MAGNIFIER

- X1 or X10 magnification of the display horizontally (digital readout not affected).

DELAY RANGE

- 1 ns/div through 0.1 μ s/div—1000 ns delay range.
- 0.2 μ s/div through 10 μ s/div—100 μ s delay range.
- 20 μ s/div through 100 μ s/div—1000 μ s delay range.
- (No delay range for 200 μ s/div sweep range, or in real-time sampling mode.)

SAMPLES/SWEEP

- 100 or 1000 (digital readout decimal information correct only for 1000 samples/sweep).

SWEEP MODES

- Normal (repetitive), Single Sweep, Manual, or External Horizontal for external input (deflection factor is adjustable from 5 V/div to 25 V/div). Front-panel START button for single-sweep operation.

TRIGGERING

- SOURCES (AC-Coupled): Internal—if Sampling Unit contains a trigger pickoff; External, 50- Ω terminated input.
- AMPLITUDE (EXT): Sinewaves, 10 mV to 500 mV peak-to-peak; Pulses, 5 mV to 250 mV, either polarity.



REPETITION RATE: Sinewaves from 100 kHz through 1 GHz. Pulses from 30 Hz through 1 GHz.

JITTER: Depends on signal shape, repetition rate and amplitude; ≤ 200 ps under optimum conditions.

PULSE OUTPUT

Approximately 500 mV into 50 Ω negative going. Coincides with trigger recognition.

HORIZONTAL OUTPUT

1 V for each division of displayed signal through 10 k Ω .

WEIGHTS

Net weight	5 $\frac{3}{4}$ lb	2.6 kg
Domestic shipping weight	≈ 11 lb	≈ 5.0 kg
Export-packed weight	≈ 16 lb	≈ 7.3 kg

INCLUDED STANDARD ACCESSORIES

- 5-ns 50- Ω RG58 cable with BNC connectors (012-0057-01);
- 10X 50- Ω BNC attenuator (011-0059-00);
- GR-to-BNC female adapter (017-0063-00);
- GR-to-BNC male adapter (017-0064-00);
- circuit board connector (388-0805-00);
- two instruction manuals (070-0439-00).

OPTIONAL ACCESSORIES

- Type 283 Real-Time Adapter Connector, 19-pin male. Mates with front-panel connector on Type 3T4 for remote programming, order 131-0388-00
- Remote Program Cable, 10 ft, 19-pin male and 36-pin male connectors, order 012-0101-00

Please refer to Terms and Shipment, General Information page.

TRANSISTOR-CURVE TRACER

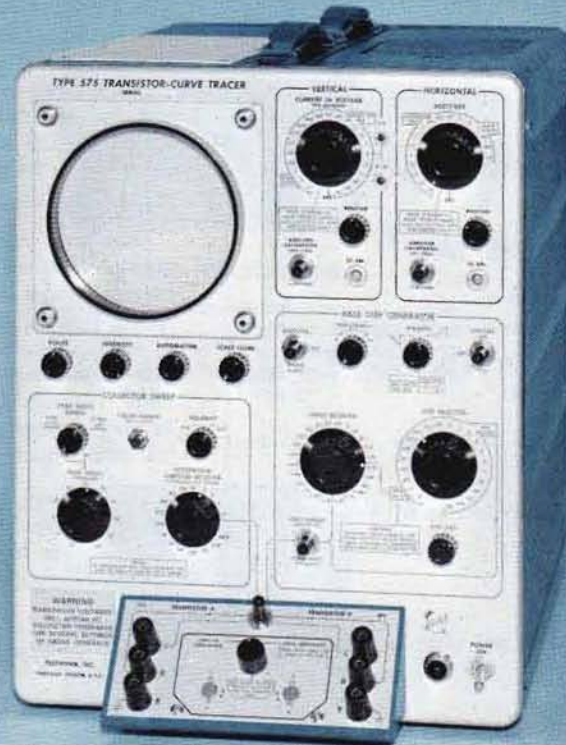

- **DISPLAY DYNAMIC CHARACTERISTIC CURVES**
- **DIRECT COMPARISON OF TRANSISTOR CHARACTERISTICS**
- **MAKE DIODE MEASUREMENTS**

The Type 575 Transistor-Curve Tracer displays the dynamic characteristic curves of both NPN and PNP transistors on the screen of a 5-inch cathode-ray tube. Several different transistor characteristic curves may be displayed, including the collector family in the common-base and common-emitter configuration. In addition to the transistor characteristic curves, the Type 575 is used to display dynamic characteristics of a wide range of semiconductor devices.

A special model (Type 575 MOD 122C), although similar to the Type 575, provides much higher voltages for diode breakdown test and collector supply. Horizontal deflection factor selections are extended to 200 V/div to accommodate the higher voltages.

Transistors under test are inserted into either a common-base or common-emitter test circuit. The transistor collector has a sweep voltage applied to it while a step voltage or current is applied to either the base or emitter (whichever is ungrounded). Voltage, for the collector, sweeps between zero and a selectable value and is generated by the Collector Sweep Generator. The Base or Emitter Step Generator applies steps to the base or emitter that start at zero and build up to a value determined by the number of steps and value of each step as selected with front-panel controls. Each sequence of steps, from zero to the maximum attained value, in conjunction with the sweep voltage on the collector produces one family of characteristic curves.

CHARACTERISTIC SUMMARY

BASE OR EMITTER STEP GENERATOR—

Type of Steps—Steps are increments of voltage or current and are either positive or negative.

Voltage Increments—Selectable from 10 mV/step to 0.2 V/step $\pm 3\%$ with 2.4-A current capability.

Current Increments—Selectable from 1 μ A/step to 200 mA/step, $\pm 3\%$.

Stepping Rate—2 or 4 times line frequency.

Number of Steps—Continuously variable from 4 to 12 steps per family of characteristic curves.

Single or Repetitive—Stops after a single family of curves is generated, or repeatedly generates the family of curves.

COLLECTOR SWEEP GENERATOR—

Frequency—2 times line frequency.

Peak Sweep Voltage—Continuously variable from 0 V to 20 V minimum with 1-A capability and from 0 V to 200 V minimum with 1-A capability.

Type 575 MOD 122C: Continuously variable from 0-20 V minimum with 10-A capability, 0-200 V minimum with 1-A capability or 0-400 V minimum with 0.5-A capability.

Polarity—positive or negative. A third switch position is added on Type 575 MOD 122C providing 0-1.5 kV for diode breakdown test.

TYPE 575

VERTICAL DISPLAY

CALIBRATED DEFLECTION FACTOR—

Transistor Collector Current—1 $\mu\text{A}/\text{div}$ to 2 A/div, $\pm 3\%$.

Transistor Base or Emitter Current—1 $\mu\text{A}/\text{div}$ to 200 mA/div, $\pm 3\%$.

Transistor Base or Emitter Voltage—10 mV/div to 0.5 V/div, $\pm 3\%$.

Base or Emitter Source Voltage—10 mV/div to 0.2 V/div, $\pm 3\%$.

HORIZONTAL DISPLAY

CALIBRATED DEFLECTION FACTOR—

Transistor Collector Voltage—10 mV/div to 20 V/div, $\pm 3\%$.

Transistor Base or Emitter Current—1 $\mu\text{A}/\text{div}$ to 200 mA/div, $\pm 3\%$.

Transistor Base or Emitter Voltage—10 mV/div to 0.5 V/div, $\pm 3\%$.

Base or Emitter Source Voltage—10 mV/div to 0.2 V/div, $\pm 3\%$.

CRT

DISPLAY AREA—10 x 10 div ($5/16$ in per div).

ACCELERATING VOLTAGE—4 kV.

PHOSPHOR—P31

OTHER CHARACTERISTICS

COMPARISON SWITCH—Switch allows switching between two semiconductors for comparison.

POWER REQUIREMENTS—105 to 125 V or 210 to 250 V, 50 to 60 Hz, 410 watts max.

COLLECTOR SWEEP GENERATOR

The Collector Sweep Generator provides the sweep voltages that drive the collector of the transistor under test. These voltages sweep between zero and a peak value selected with a front-panel control. The peak voltage is either positive or negative depending on the setting of the polarity switch to allow the collector voltages to sweep between zero and positive peak values or zero and negative peak values. The repetition rate of the sweep is 2 times the line frequency; thus the collector voltage sweeps between zero and the peak value at least once for each step applied to the transistor base or emitter.

The peak sweep voltage is continuously adjustable from zero to 20 V with 10-A capability or from zero to 200 V with 1-A current capability. (Additional 0 to 400-V with 0.5-A current capability is provided on Type 575 MOD 122C.)

The collector current limiting resistance is selected from 16 values ranging from 1 ohm to 100 kilohms $\pm 5\%$.

On Type 575 MOD 122C, a third position has been added to the POLARITY switch, providing zero to 1.5 kV for checking diode breakdown voltage.

BASE OR EMITTER STEP GENERATOR

The Step Generator develops current or voltage steps to drive the base or emitter (whichever is ungrounded) of the transistor under test. These steps are used to generate either repetitive or single-family (as selected) characteristic curves for display. The steps are adjustable in number from 4 to 12 and move in a positive or negative direction depending on the polarity switch setting. Step repetition rate is selectable as either 120 steps/s or 240 steps/s (values equal to 2X or 4X the line frequency). A control is available to set the starting point of a series of steps to zero.

Each step has a rise that is selected as either a value of current or a value of voltage. The value of each step rise in current ranges from 0.001 mA/step to 200 mA/step and is selected from 17 values that are in a 1-2-5 sequence. The value of each step rise in voltage is from 0.01 V/step to 0.2 V/step and is selected from 5 values that are in a 1-2-5 sequence. Also a switch is provided for grounding the transistor input to give a zero drive-voltage reference check, and opening the transistor input to give a zero drive-current reference check.

The driving resistance of the step generator, when developing voltage steps, is selected from 24 values that range from 1 ohm to 22 kilohms $\pm 10\%$. Any other value can be added externally.

VERTICAL-DEFLECTION SYSTEM

Signals used for vertical deflection are selected from various points in the transistor test circuit. Each point has several selectable deflection factors available.

CALIBRATED DEFLECTION FACTOR

Transistor Collector Current—10 $\mu\text{A}/\text{div}$ to 1 A/div in 16 steps, 1-2-5 sequence. Pushbuttons are provided for multiplying each step by 2 or 0.1 thus extending the deflection factor from 1 $\mu\text{A}/\text{div}$ to 2 A/div.

Transistor Base or Emitter Current—1 $\mu\text{A}/\text{div}$ to 200 mA/div in 17 steps, 1-2-5 sequence.

Transistor Base or Emitter Voltage—10 mV/div to 0.5 V/div in 6 steps, 1-2-5 sequence.

Base or Emitter Source Voltage—10 mV/div to 0.2 V/div in 5 steps, 1-2-5 sequence.

HORIZONTAL-DEFLECTION SYSTEM

Signals used for horizontal deflection are selected from various points in the transistor test circuit. Each point has several selectable deflection factors available.

CALIBRATED DEFLECTION FACTOR

Transistor Collector Voltage—0.01 V/div to 20 V/div in 11 steps, 1-2-5 sequence. (0.1 V/div to 200 V/div on Type 575 MOD 122C).

Transistor Base or Emitter Current—0.001 mA/div to 200 mA/div in 17 steps, 1-2-5 sequence.

Transistor Base or Emitter Voltage—0.01 V/div to 0.5 V/div in 6 steps, 1-2-5 sequence.

Base or Emitter Source Voltage—0.01 V/div to 0.2 V/div in 5 steps, 1-2-5 sequence.

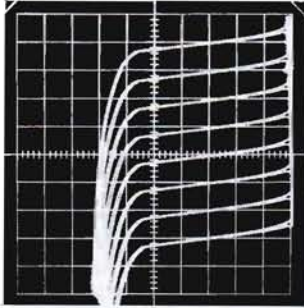

PNP TRANSISTOR

Collector current vs collector voltage with base grounded and constant-current emitter steps. Collector sweep is 0 to 120 V through a 5 k load resistor, emitter current 1 mA/step. Vertical deflection is 1 mA/div, horizontal deflection 10 V/div.

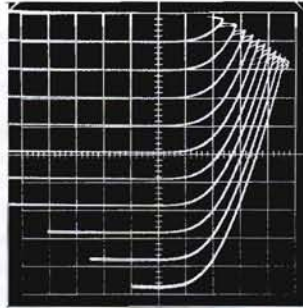

PNP TRANSISTOR

Collector current vs collector voltage with base grounded and constant-current emitter steps. Collector sweep is 0 to 1.5 V, emitter current 200 mA/step. Vertical deflection is 200 mA/div, horizontal deflection 0.1 V/div.

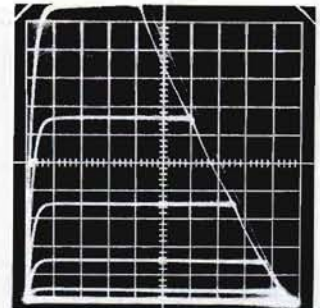

NPN TRANSISTOR

Collector current vs collector voltage with constant-voltage base steps. Collector sweep is 0 to 2 V, base voltage 0.02 V/step, vertical deflection is 5 mA/div, horizontal deflection 0.2 V/div.

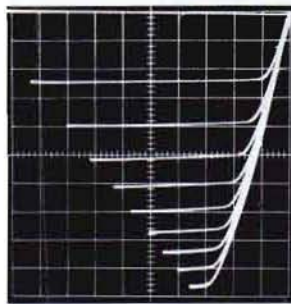

PNP TRANSISTOR

Collector current vs collector voltage with constant-current base steps. Collector sweep is 0 to 5 V with a 0.25-ohm load, base current is 50 mA/step. Vertical deflection is 1000 mA/div, horizontal deflection 0.5 V/div.

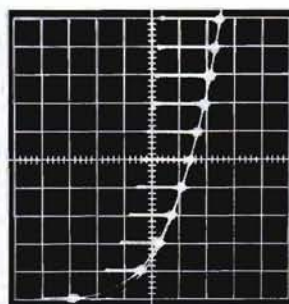

NPN TRANSISTOR

Base current vs base voltage with constant-current base steps. Collector sweep is 0 to 1 V, base current 0.1 mA/step. Vertical deflection is 0.1 mA/div, horizontal deflection 0.05 V/div. Dots represent equal increments of base current. Dynamic base impedance can be determined from this display.

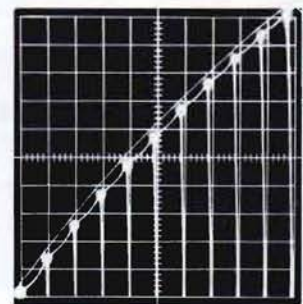

NPN TRANSISTOR

Collector current vs base current with constant-current base steps. Collector sweep is 0 to 1.5 V, base current 0.1 mA/step. Vertical deflection is 5 mA/div collector current, horizontal deflection 0.1 mA/div base current. Incremental and DC current gain can be determined from this display.

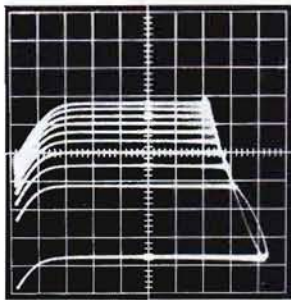

NPN TRANSISTOR

Base voltage vs collector voltage with constant-current base steps. Collector sweep is 0 to 1 V, base current 0.1 mA/step. Vertical deflection is 0.05 V/div base voltage, horizontal deflection 0.1 V/div collector voltage.

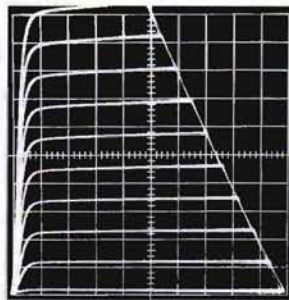

NPN TRANSISTOR

Collector current vs collector voltage with constant-current base steps. Collector sweep is 0 to 2 V, base current 0.01 mA/step. Vertical deflection is 0.5 mA/div, horizontal deflection 0.2 V/div.

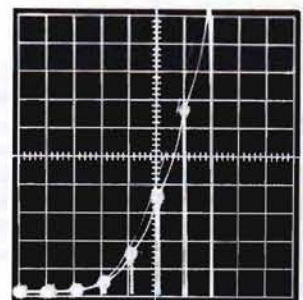

NPN TRANSISTOR

Collector current vs base voltage with constant-voltage base steps. Collector sweep is 0 to 1.5 V, base voltage 0.05 V/step with a 1-ohm source impedance. Vertical deflection is 0.5 mA/div, horizontal deflection 0.05 V/div.

TYPE 575

CRT

TEKTRONIX CRT

4-kV accelerating voltage, P31 phosphor normally supplied. Other phosphors available on request.

GRATICULE

External, $3\frac{1}{8}$ in x $3\frac{1}{8}$ in viewing area, 10 divisions each axis with each division measuring $\frac{5}{16}$ in.

OTHER CHARACTERISTICS

TRANSISTOR TEST PANEL—The transistor test panel has provisions for two transistors at the same time. Two sockets accept low-power transistors with short leads and three binding posts alongside the sockets accept other transistor and semiconductors. One switch will change the sockets from the common-emitter to the common-base test circuit configuration. A second switch allows two transistors inserted into the test circuit to be rapidly compared by switching the test conditions from one to the other.

POWER REQUIREMENT

Wired for 105 to 125 VAC (117-V nominal); may be ordered with transformer taps connected for nominal values of 107, 127, 214, 234, or 254 V; 50 to 60 Hz. 410 watts maximum.

TYPE 575 AND TYPE 575 MOD 122C DIMENSIONS AND WEIGHTS

Height	$16\frac{3}{8}$ in	41.6 cm
Width	13 in	33 cm
Depth	$23\frac{5}{8}$ in	60 cm
Net weight	$66\frac{1}{4}$ lb	30.1 kg
Domestic shipping weight	≈ 84 lb	≈ 38.2 kg
Export-packed weight	≈ 102 lb	≈ 46.4 kg

TYPE 575 AND TYPE 575 MOD 122C INCLUDED STANDARD ACCESSORIES

Two transistor adapters, long lead (013-0069-00); two transistor adapters, TO-3 (013-0070-00); 3 to 2-wire adapter (103-0013-00); two 2N1381 transistors (151-0039-00); 3-conductor power cord (161-0010-03); smoke gray filter (378-0567-00); two instruction manuals (070-0255-00).

INCREASED COLLECTOR VOLTAGE

Type 575 MOD 122C, although similar to the Type 575, provides much higher diode breakdown test voltage (variable from zero to 1.5 kV, maximum short circuit current of 1 mA); also provides much higher collector supply (up to 400 V at 0.5 A).

OPTIONAL ACCESSORIES

Optional accessories increase measurement capability and provide added convenience. See catalog accessory pages for additional information on these and other items.

RACK MOUNT ADAPTER

Cradle mount to adapt the Type 575 Transistor-Curve Tracer for rack mounting. Consists of a cradle to support instrument in any standard 19-in relay rack and mask to fit around regular instrument panel. Tektronix blue vinyl finish. Rack height requirements $17\frac{1}{2}$ in. Order 040-0281-00

TYPE 575 OPTIONAL TEST FIXTURES

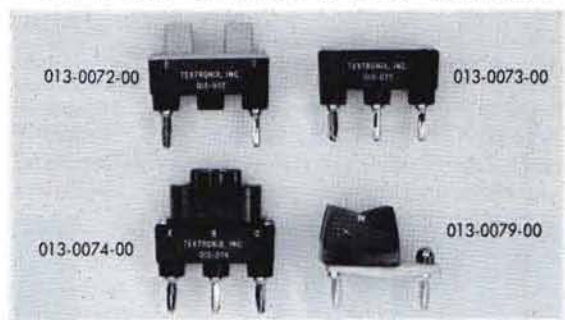

DIODE TEST FIXTURE

Holds axial-lead diodes. Order 013-0072-00

ADAPTER BOX

Allows mounting of additional semiconductor sockets. Order 013-0073-00

POWER TRANSISTOR SOCKET

For power transistors with hook leads. Order 013-0074-00

DIODE TEST ADAPTER

Production test fixture for rapid handling. Order 013-0079-00

CAMERA

The standard C-12 camera satisfies most trace-recording requirements. For applications that might require a different viewing system, lens, or back, refer to camera descriptions or consult your field engineer, representative, or distributor.

Standard C-12: f/1.9 — 1:0.85 lens, on-axis, no parallax viewing, Polaroid Land* Pack-Film back

Mounting Adapter for C-12, order 016-0226-00

SCOPE-MOBILE® CART

Model 202-2: storage drawer, 9-position tilt-lock oscilloscope tray

*Registered Trade-Mark, Polaroid Corporation.

Please refer to Terms and Shipment, General Information page.

HIGH-CURRENT ADAPTER



- **200-A COLLECTOR DISPLAYS**

- **12-A BASE SUPPLY**

The Type 175 Transistor-Curve Tracer High-Current Adapter enables the Type 575 to plot and display characteristic curves of high-current semiconductors. Basically the Type 175 contains a high-current Collector Sweep Generator, a high-current Base or Emitter Step Generator and high-current test circuits that are used in place of those in the Type 575. The 175 also contains the necessary circuits to convert these high currents into deflection signals suitable for display on the Type 575 CRT. There is one source for the vertical deflection signal: the transistor collector current. There are two sources for the horizontal deflection signal: transistor collector voltage and transistor base or emitter voltage.

CHARACTERISTIC SUMMARY

BASE OR EMITTER STEP GENERATOR

Type of Steps—Steps are increments of voltage or current and are either positive or negative.

Voltage Increments—Selectable from 20 mV/step to 0.5 V/step with 12-A current capability.

Current Increments—Selectable from 1 mA/step to 1 A/step.

Stepping Rate—2 or 4 times line frequency.

Number of Steps—Continuously variable from 4 to 12 steps per family of characteristic curves.

Single or Repetitive—Stops after a single family of curves is generated, or repeatedly generates the family of curves.

COLLECTOR SWEEP GENERATOR

Frequency—2 times line frequency.

Peak Sweep Voltage—Continuously variable from 0 V to 20 V with 200-A capability and 0 V to 100 V with 40-A capability.

Polarity—positive or negative.

VERTICAL

CALIBRATED DEFLECTION FACTOR

Transistor Collector Current—5 mA/div to 20 A/div.

HORIZONTAL

CALIBRATED DEFLECTION FACTOR

Transistor Collector Voltage—0.1 V/div to 10 V/div.

Transistor Base or Emitter Voltage—0.1 V/div to 2 V/div.

OTHER

COMPARISON SWITCH—Allows switching between two semiconductors for comparison.

POWER REQUIREMENTS—105 to 125 V, 50 to 60 Hz, 1100 watts max.

BASE STEP GENERATOR

The Type 175 step generator produces ten input steps of constant current from 1 mA/step to 1 amp/step and five input steps of constant voltage from 0.02 V/step to 0.5 V/step. A polarity switch provides for stepping the input in either the positive or negative direction. The STEPS/FAMILY control on Type 575 adjusts the number of steps per family from 4 to 12. A repetitive or single-family display can be presented. Either a 120-steps/s or 240-steps/s repetition rate can be selected. When used with a 50-cycle supply, the step/s rate will be either 100 or 200.

A switch grounds the transistor input for a zero voltage reference check, and opens the transistor input for a zero current reference check. The starting point of input current or voltage steps can be adjusted with the STEP ZERO control.

When constant-voltage input steps are in use, a resistance is inserted in series with the source impedance of the step generator. This driving resistance can be selected from eleven values, 0.5 ohms to 1,000 ohms.

TYPE 175

COLLECTOR SWEEP GENERATOR

The Collector Sweep Generator provides the sweep voltages that drive the collector of the transistor under test. These voltages sweep between zero and a peak value selected with a front-panel control. The peak voltage is either positive or negative depending on the setting of the polarity switch to allow the collector voltages to sweep between zero and positive peak values or zero and negative peak values. The repetition rate of the sweep is 2 times the line frequency; thus the collector voltage sweeps between zero and the peak value at least once for each step applied to the transistor base or emitter.

The peak sweep voltage is continuously adjustable from zero to 20 V with 200-A capability or from zero to 100 V with 40-A capability. Also, in the 0-100 V range a 300-ohm collector-current-limiting resistor can be switched in. Any other desired resistance can be added externally.

VERTICAL-DEFLECTION SYSTEM

The signal used for vertical deflection is the transistor collector current from the transistor test circuit.

CALIBRATED DEFLECTION FACTOR

Transistor Collector Current—5 mA/div to 20 A/div in 12 steps, 1-2-5 sequence.

HORIZONTAL-DEFLECTION SYSTEM

Signals used for horizontal deflection are selected from various points in the transistor test circuit. Each point has several selectable deflection factors available.

CALIBRATED DEFLECTION FACTOR

Transistor Collector Voltage—0.1 V/div to 10 V/div in 7 steps, 1-2-5 sequence.

Transistor Base or Emitter Voltage—0.1 V/div to 2 V/div in 5 steps, 1-2-5 sequence.

OTHER

TRANSISTOR TEST PANEL

The Type 175 Transistor Test Panel is basically the same as that of the Type 575. Special connectors and cables are provided for high-current applications and for eliminating measurement errors due to voltage drops in high-current carrying leads.

POWER REQUIREMENT

Type 175 wired for 105 to 125 V, 50 to 60 Hz, 1100 watts maximum. Type 175 MOD 167C wired for 210 to 250 V, 50 to 60 Hz, 1100 watts maximum.

TYPE 175 AND TYPE 175 MOD 167C DIMENSIONS AND WEIGHTS

Height	12 ¹ / ₁₆ in	30.7 cm
Width	13 ¹ / ₁₆ in	33.2 cm
Depth	23 ⁵ / ₈ in	60 cm
Net weight	83 ¹ / ₂ lb	38 kg
Domestic shipping weight	117 lb	53.2 kg
Export-packed weight	139 lb	63.2 kg

TYPE 175 AND TYPE 175 MOD 167C STANDARD ACCESSORIES

Two black output leads (012-0014-00); two red output leads (012-0015-00); interconnecting cable (012-0042-00); two red test cables (012-0043-00); two black test cables (012-0044-00); 575 adapter cable (012-0045-00); two blue test leads (012-0056-00); 3 to 2-wire adapter (103-0013-00); 3-conductor power cord (161-0010-03); 3-conductor power cord, 20-in (161-0014-00); two lock washers (210-0010-00); two nuts (210-0410-00); two screws (212-0520-00); two bolt hinges (214-0152-00); two instruction manuals (070-0255-00).

CHARACTERISTIC CURVE DISPLAYS WITH TYPE 175

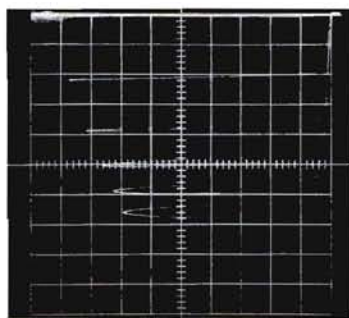

Collector current vs collector voltage (emphasis on saturation resistance). Vertical deflection is 10 A/div, horizontal deflection is 0.2 V/div. Base drive is 500 mA/step (top curve is 2.5 A).

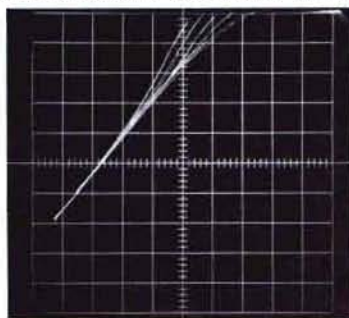

Collector current vs base voltage (collector sweep voltage is 4.2 V). Vertical deflection is 10 A/div, horizontal deflection is 0.1 V/div. Base drive is 500 mA/step.

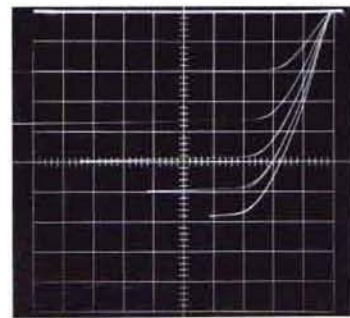

Collector current vs collector voltage. Vertical deflection is 10 A/div, horizontal deflection is 1.0 V/div. Base drive is 500 mA/step (top curve is 2.5 A).

DC-to-80 MHz OSCILLOSCOPE



- **ILLUMINATED PARALLAX-FREE GRATICULE**
- **TUNNEL-DIODE TRIGGERING TO BEYOND 150 MHz**
- **SINGLE SWEEP**
- **SINGLE-TRACE AND DUAL-TRACE PLUG-IN UNITS**
- **MORE THAN 20 OTHER VERTICAL PLUG-IN UNITS (with adapter)**

The Type 581A Oscilloscope is a general-purpose, laboratory instrument featuring bandwidth to 80 MHz (at 3-dB down) when used with the Type 82 or Type 86 Plug-In Units. Tunnel-diode triggering to 150 MHz and HF Sync to 250 MHz makes the instrument useful beyond the specified bandwidth. The Type 81A Plug-In Adapter provides additional versatility by permitting the use of more than 20 Tektronix 1-series and letter-series plug-in units.

CHARACTERISTIC SUMMARY

VERTICAL

Dual-trace displays from DC to 80 MHz (3-dB down) at 100 mV/cm or from DC to 75 MHz (3-dB down) at 10 mV/cm are available with the Type 82 Dual-Trace Plug-In Unit. Other vertical-deflection characteristics are available (with Type 81A adapter) through use of a wide variety of plug-in units.

HORIZONTAL

CALIBRATED TIME BASE—50 ns/cm to 2 s/cm.

SWEEP MAGNIFIER—X5, increases sweep rate to 10 ns/cm.

EXTERNAL INPUT—0.2 V/cm to 15 V/cm; DC to 350 kHz.

CRT

DISPLAY AREA—4 x 10 cm.

ACCELERATING VOLTAGE—10 kV.

PHOSPHOR—P31.

OTHER

AMPLITUDE CALIBRATOR—0.2 mV to 100 V, 1-kHz square-wave.

POWER REQUIREMENT—Wired for 105 to 125 V, may be ordered with taps connected for 210 to 250 V. 50 to 60 Hz, 560 watts maximum.

TYPE 581A

VERTICAL DEFLECTION

BANDWIDTH AND RISE TIME

Bandwidth figures are at 3-dB down.

TYPE 82 or 86 PLUG-IN UNIT	MINIMUM BANDWIDTH	MAXIMUM RISE TIME
at 100 mV/cm	80 MHz	4.4 ns
at 10 mV/cm	75 MHz	4.7 ns

BALANCED DELAY NETWORK

Permits observation of the leading edge of the waveform that triggers the sweep.

HORIZONTAL DEFLECTION

TIME BASE

50 ns/cm to 2 s/cm in 24 calibrated steps (1-2-5 sequence), accurate within 3%. Continuously variable (uncalibrated) between steps and to approx 5 s/cm. Warning light indicates uncalibrated setting.

DISPLAY MODES

Normal (repetitive) and single-sweep.

X5 MAGNIFIER

Operates over full time base, increases the fastest rate to 10 ns/cm. Magnified time base accurate within 5%.

EXTERNAL INPUT

Continuously variable deflection factor from 0.2 V/cm to 15 V/cm. DC to 350 kHz at maximum gain. Input RC approx 1 megohm paralleled by approx 47 pF.

SIGNAL OUTPUTS

A positive gate of approx 20 V and a positive-going sawtooth of approx 150 V.

TRIGGER

SOURCES

Internal, external, or line. Internal sources are AC coupled. External sources are AC or DC coupled. External trigger input RC approx 1 megohm paralleled by approx 30 pF.

REQUIREMENTS

2-mm deflection or 0.3 V external from 15 Hz to 5 MHz. Requirements increase below 15 Hz with AC coupling, below 15 kHz with AC LF Reject. HF Sync requires 4-mm deflection or 0.2 V external from 5 MHz to 250 MHz.

CRT

TEKTRONIX CRT

5-in CRT, accelerating potential 10 kV. P31 phosphor normally supplied. Z-axis input requires 20 V peak-to-peak for beam modulation at normal intensity.

GRATICULE

Parallax-free, 4 x 10 cm, internal graticule with variable edge illumination, ruled in 1-cm divisions. Vertical and horizontal centerlines further marked in 2-mm increments.

DISPLAY FEATURES

Beam-position indicators light to show direction of CRT beam when off the screen.

OTHER CHARACTERISTICS

AMPLITUDE CALIBRATOR

Squarewaves from 0.2 mV to 100-V in 18 steps (1-2-5 sequence), accurate within 3%, approx 1-kHz repetition rate.

POWER OPTIONS

Wired for 105 to 125-V operation, 50 to 60 Hz. Tapped transformer allows operation also at 210 to 250 V. Power consumption 560 watts maximum.

DIMENSIONS AND WEIGHTS

Height	16 ⁷ / ₈ in	42.9 cm
Width	13 ¹ / ₈ in	33.4 cm
Depth	23 ⁷ / ₈ in	58.2 cm
Net weight	63 lb	28.6 kg
Domestic shipping weight	≈81 lb	≈36.8 kg
Export-packed weight	≈99 lb	≈45.0 kg

INCLUDED STANDARD ACCESSORIES

3 to 2-wire adapter (103-0013-00); 3-conductor power cord (161-0010-03); smoke-gray filter, installed (378-0567-00); clear, CRT-protector plate (387-0918-00); 18-in BNC-to-BNC patch cord (012-0087-00); 18-in BNC-to-banana plug patch cord (012-0091-00); post jack, BNC (012-0092-00); two instruction manuals (070-0390-01).

OPTIONAL ACCESSORIES

Optional accessories increase measurement capability and provide added convenience. See catalog accessory pages for additional information on these and other items.

C27-662 R CAMERA

Equipped with a special lens to permit single-sweep photography of Type 581A Oscilloscope displays at fast writing rates. 1:0.5, f1/3 lens; Polaroid Land* roll-film back.

Mounting Adapter, order 016-0225-00

PROBES

The standard 10X probes supplied with plug-in units satisfy most measurement requirements; however, optional probes (recommended on plug-in unit pages) may be better suited for particular applications.

SCOPE-MOBILE® CART

Model 202-2: storage drawer, carrier for 2 plug-in units, 9-position tilt-lock oscilloscope tray.

*Registered Trade-Mark, Polaroid Corporation

Please refer to Terms and Shipment, General Information Page

DC-to-80 MHz SWEEP DELAY OSCILLOSCOPES



- **CALIBRATED SWEEP DELAY**
- **TUNNEL DIODE TRIGGERING TO BEYOND 150 MHz**
- **ILLUMINATED PARALLAX-FREE GRATICULE**
- **SINGLE SWEEP**
- **SINGLE-TRACE AND DUAL-TRACE VERTICAL PLUG-IN UNITS**
- **MORE THAN 20 OTHER VERTICAL PLUG-IN UNITS (with adapter)**

Type 585A and Type RM585A are general-purpose laboratory instruments. Features are designed to permit signal analysis from DC to 80 MHz (3-dB down) and beyond. Tunnel Diode triggering from DC to 150 MHz, 10 ns/cm sweep speed, and calibrated sweep delay complement the response characteristic of the Type 82 Dual-Trace Plug-In Unit or Type 86 Single-Trace Plug-In Unit. The Type 81A Adapter permits use of any letter series or 1-series plug-in units: adding Sampling, Spectrum Analysis, and High Gain Differential measurement capability.

CHARACTERISTIC SUMMARY

VERTICAL

Dual-Trace DC to 80 MHz (approx 3-dB down) displays at 100 mV/cm or DC to 75 MHz (approx 3-dB down) displays at 10 mV/cm are available with the Type 82 Dual-Trace Plug-In Unit. Extreme flexibility of vertical deflection characteristics through the use of a wide variety of plug-in units.

HORIZONTAL

CALIBRATED TIME BASE—Time Base A: 50 ns/cm to 2 s/cm; Time Base B: 2 μ s/cm to 1 s/cm.

SWEEP MAGNIFIER—X5, extends Time Base A to 10 ns/cm.

CALIBRATED SWEEP DELAY—2 μ s to 10 s, continuously variable.

EXTERNAL INPUT—0.2 V/cm to 15 V/cm; DC to 350 kHz at maximum gain.

CRT

DISPLAY AREA—4 x 10 cm.

ACCELERATING VOLTAGE—10 kV.

PHOSPHOR—P31.

OTHER

AMPLITUDE CALIBRATOR—0.2 mV to 100 V, 1-kHz square-wave.

POWER REQUIREMENT—105 to 125 V or 210 to 250 V, 50 to 60 Hz, 630 watts maximum.

TYPE **585A** **RM585A**

VERTICAL DEFLECTION

BANDWIDTH AND RISE TIME

Bandwidth figures are at 3-dB down.

TYPE 82 OR 86 PLUG-IN UNIT	MINIMUM BANDWIDTH	MAXIMUM RISE TIME
at 100 mV/cm	80 MHz	4.4 ns
at 10 mV/cm	75 MHz	4.7 ns

BALANCED DELAY NETWORK

Permits observation of the leading edge of the waveform that triggers the sweep.

HORIZONTAL DEFLECTION

TIME BASE A

50 ns/cm to 2 s/cm in 24 calibrated steps (1-2-5 sequence), accurate within 3%. Continuously variable (uncalibrated) between steps and to approximately 5 s/cm. Warning light indicates uncalibrated setting.

TIME BASE B

2 μ s/cm to 1 s/cm in 18 calibrated steps (1-2-5 sequence), accurate within 3%. Control for varying sweep length from 4 to 10 cm permits Time Base B to be used as a repetition-rate generator from 0.1 Hz to 40 kHz.

X5 MAGNIFIER

Operates over full time base, increases the fastest Time Base A rate to 10 ns/cm and fastest Time Base B rate to 0.4 μ s/cm. Magnified time base accurate within 5%.

DELAY TIME

2 μ s to 10 s, continuously variable and calibrated. Accuracy from 2 μ s to 0.1 s within 1% of indicated delay. Accuracy from 0.2 s to 1 s within 3% of indicated delay. Incremental delay time accurate within 0.2% of the available delay time. Short-term jitter less than 1 part in 20,000 of the available delay time.

OPERATING MODES

Time Base A: Normal, single sweep, delayed by B.

Time Base B: Normal, intensified by A.

EXTERNAL INPUT

Continuously variable deflection factor from 0.2 V/cm to 15 V/cm. DC to 350 kHz at maximum gain. Input RC approx 1 megohm paralleled by approx 47 pF.

SIGNAL OUTPUTS

Positive gates from both time bases of approx 20 V, a positive-going sawtooth of approx 150 V and a delayed trigger pulse of approx +5 V.

CRT

TEKTRONIX CRT

5-in CRT metalized, accelerating potential 10 kV. P31 phosphor normally supplied. Z-axis input requires 20 V peak to peak for beam modulation at normal intensity.

GRATICULE

Parallax-free, 4 x 10 cm, internal graticule with variable edge illumination is ruled in 1-cm divisions with vertical and horizontal centerlines further marked in 2-mm increments.

DISPLAY FEATURES

Beam-position indicators light to show direction of CRT beam when it is off the screen.

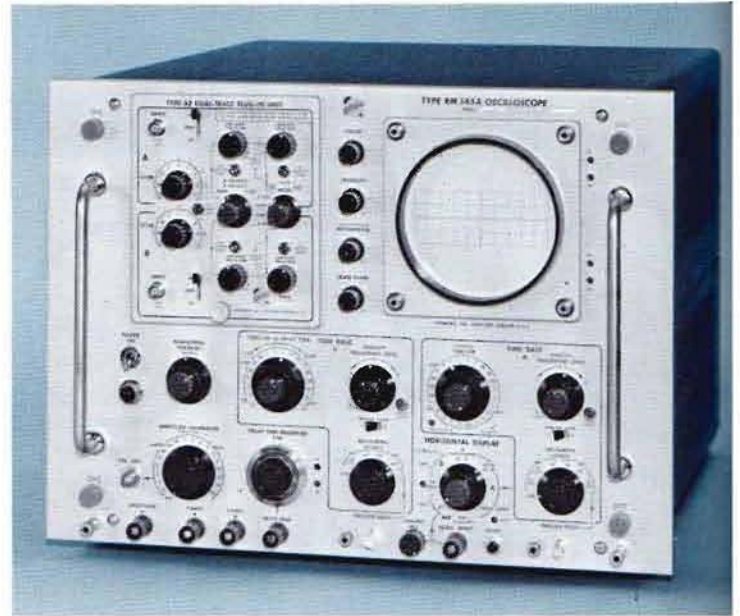

TRIGGER

SOURCES

Internal, external, or line. Internal sources are AC coupled. External sources are AC or DC coupled. External trigger input RC approx 1 megohm paralleled by approx 30 pF.

TIME BASE A REQUIREMENTS

2-mm deflection or 0.3 V external from 15 Hz to 5 MHz. Requirements increase below 15 Hz with AC coupling, below 15 kHz with AC LF Reject. HF Sync requires 4-mm deflection or 0.2 V external from 5 MHz to 250 MHz.

TIME BASE B REQUIREMENTS

4-mm deflection or 0.5-V external from 15 Hz to 1 MHz, increasing to 2-cm deflection or 1.5-V external at 5 MHz. Requirements increase below 15 Hz with AC coupling, below 15 kHz with AC LF Reject.

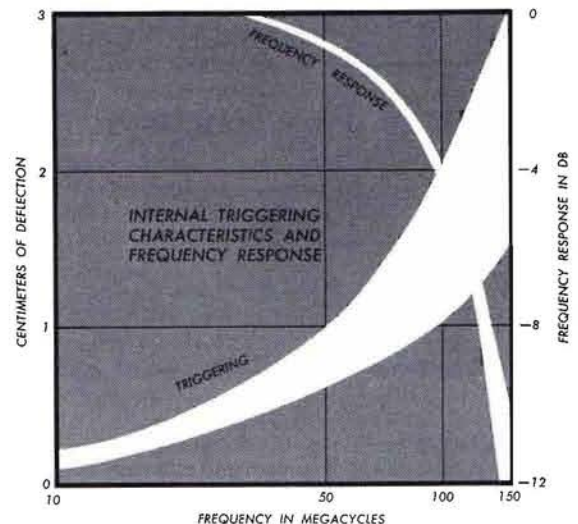

OTHER CHARACTERISTICS

AMPLITUDE CALIBRATOR

0.2 mV to 100-V squarewave in 18 steps (1-2-5 sequence). Accurate within 3%. Approx 1-kHz repetition rate.

POWER OPTIONS

Wired for 105 to 125-V operation, 50 to 60 Hz. Tapped transformer allows operation at 210 to 250 V. Power consumption 630 watts maximum.

TYPE 585A DIMENSIONS AND WEIGHTS

Height	16 $\frac{7}{8}$ in	42.9 cm
Width	13 $\frac{7}{8}$ in	33.4 cm
Depth	23 $\frac{7}{8}$ in	58.2 cm
Net weight	67 $\frac{1}{4}$ lb	30.6 kg
Domestic shipping weight	≈ 85 lb	≈ 38.6 kg
Export-packed weight	≈ 104 lb	≈ 47.3 kg

TYPE RM585A DIMENSIONS AND WEIGHTS

Height	14 in	35.6 cm
Width	19 in	48.3 cm
Depth	22 $\frac{3}{4}$ in	57.8 cm
Net weight	83 $\frac{1}{2}$ lb	38.0 kg
Domestic shipping weight	≈ 108 lb	≈ 49.1 kg
Export-packed weight	≈ 131 lb	≈ 59.5 kg

INCLUDED STANDARD ACCESSORIES

3 to 2-wire adapter (103-0013-00); 3-conductor power cord (161-0010-03); smoke-gray filter, installed (378-0567-00); clear CRT-protector plate (387-0918-00); 18-in BNC-to-BNC patch cord (012-0087-00); 18-in BNC-to-banana-plug patch cord (012-0091-00); BNC post jack (012-0092-00); Type 585A—two instruction manuals (070-0391-01). Type RM585A—two instruc-

tion manuals (070-0392-00); set mounting hardware included with Type RM585A.

OPTIONAL ACCESSORIES

Optional accessories increase measurement capability and provide added convenience. See catalog accessory pages for additional information on these and other items.

C27-662 R CAMERA

Equipped with a special lens to permit single-sweep photography of Type 585 Oscilloscope displays at fast writing rates. 1:0.5, f1/3 lens; Polaroid Land* roll-film back.

Mounting Adapter, order 016-0225-00

PROBES

The standard 10X probes supplied with Type 82 and Type 86 plug-in units satisfy most measurement requirements; however, optional probes (recommended on plug-in unit pages) may be better suited for particular applications.

SCOPE-MOBILE® CART

Model 202-2: storage drawer, carrier for 2 plug-in units, 9-position tilt-lock oscilloscope tray.

*Registered Trade-Mark, Polaroid Corporation

Please refer to Terms and Shipment, General Information Page

TYPE 81A

PLUG-IN

ADAPTER

The Type 81A Adapter allows use of all 1-Series and Letter-Series Plug-In Units with 580-Series Oscilloscopes. The full bandwidth capabilities of the plug-in units are realized. For example, the Type 1A5 Differential Amplifier provides DC-to-50 MHz displays at 5 mV/cm.

No cabling or switching is required; the Type 81A is simply inserted into the oscilloscope, then the plug-in unit is inserted into the adapter. Provision for chopped blanking when used with a multi-trace plug-in is not available.

WEIGHTS

Net weight	4 lb	1.8 kg
Domestic shipping weight	≈ 6 lb	≈ 3 kg
Export-packed weight	≈ 11 lb	≈ 5 kg

INCLUDED STANDARD ACCESSORIES

Instruction manual (070-0751-00).

Please refer to Terms and Shipment, General Information page.



EXTEND CAPABILITIES OF TYPE 580-SERIES OSCILLOSCOPES TO THESE AREAS

VERTICAL PLUG-IN UNITS			
PLUG-IN UNIT	MINIMUM DEFLECTION FACTOR	BANDWIDTH (−3 dB)	T _R
MULTIPLE TRACE			
1A1 Dual-Trace	50 mV/cm 5 mV/cm ≈ 500 μV/cm	DC to 50 MHz DC to 28 MHz 2 Hz to 15 MHz	7 ns 13 ns 24 ns
1A2 Dual-Trace	50 mV/cm	DC to 50 MHz	7 ns
CA Dual-Trace	50 mV/cm	DC to 24 MHz	15 ns
1A4 Four-Trace	10 mV/cm	DC to 50 MHz	7 ns
M Four-Trace	20 mV/cm	DC to 20 MHz	18 ns
SINGLE TRACE			
B	50 mV/cm 5 mV/cm	DC to 20 MHz 2 Hz to 12 MHz	18 ns 30 ns
H	5 mV/cm	DC to 15 MHz	24 ns
K	50 mV/cm	DC to 30 MHz	12 ns
L	50 mV/cm 5 mV/cm	DC to 30 MHz 3 Hz to 24 MHz	12 ns 15 ns
SPECIAL PURPOSE			
O Operational	50 mV/cm	DC to 25 MHz	14 ns
Q Strain Gage	10 μstrain/div	DC to 6 kHz	60 μs

PLUG-IN UNIT	MINIMUM DEFLECTION FACTOR	BANDWIDTH (−3 dB)	T _R
DIFFERENTIAL			
1A5 Comparator	5 mV/cm 2 mV/cm 1 mV/cm	DC to 50 MHz DC to 45 MHz DC to 40 MHz	7 ns 8 ns 9 ns
1A6	1 mV/cm	DC to 2 MHz	0.18 μs
1A7A High-Gain	10 μV/cm	DC to 1 MHz	350 ns
D	1 mV/cm (to 50 mV/cm)	DC to 300 kHz (DC to 2 MHz)	0.18 μs
E	50 μV/cm (to 10 mV/cm)	0.06 Hz to 20 kHz (to 60 kHz)	6 μs
G	50 mV/cm	DC to 20 MHz	18 ns
W Comparator	1 mV/cm 50 mV/cm	DC to 8 MHz DC to 23 MHz	44 ns 16 ns
Z Comparator	50 mV/cm	DC to 13 MHz	27 ns
SPECTRUM ANALYZERS			
1L5	10 μV/cm	10 Hz to 1 MHz	
1L10	−100 dBm	1 MHz to 36 MHz	
1L20	−110 to −90 dBm	10 MHz to 4.2 GHz	
1L30	−105 to −75 dBm	925 MHz to 10.5 GHz	
WIDE-BAND SAMPLING			
1S1	2 mV/cm	DC to 1 GHz	350 ps
1S2 TDR	5 m _p /cm 5 mV/cm	140 ps system risetime DC to 3.9 GHz	90 ps

DUAL-TRACE UNIT

- **DC TO 80 MHz AT 100 mV/cm**
- **DC TO 75 MHz AT 10 mV/cm**
- **CHOPPED OR ALTERNATE SWITCHING**

Two identical input channels add dual-trace capability to Tektronix Type 580-Series Oscilloscopes permitting the display of the time difference between two input signals, the response of two circuits to the same pulse, the input and output waveforms of a circuit, and many other dual-trace functions.

BANDWIDTH AND RISETIME

Bandwidth figures are at 3-dB down and apply to calibrated and uncalibrated deflection factors.

WITHOUT PROBE (Source impedance approx 25 ohms)			
DEFLECTION FACTOR	DC-COUPLED BANDWIDTH	AC-COUPLED LOW-FREQUENCY 3-dB POINT	RISETIME
X1 GAIN 100 mV to 50 V/cm	DC to 80 MHz	2 Hz	4.4 ns
X10 GAIN 10 mV to 5 V/cm	DC to 75 MHz	2 Hz	4.7 ns
WITH P6008 10X PROBE			
X1 GAIN 1 V to 500 V/cm	DC to 70 MHz	0.2 Hz	5 ns
X10 GAIN 100 mV to 50 V/cm	DC to 66 MHz	0.2 Hz	5.3 ns

DEFLECTION FACTOR

100 mV/cm to 50 V/cm in 9 calibrated steps (1-2-5 sequence), accurate within 3%. 2:1 variation, uncalibrated, between steps and to approx 100 V/cm.

X10 AMPLIFIER

DC coupled, extends deflection factor to 10 mV/cm. Operates at all deflection-factor settings, accurate within 3%.

P6008 10X PASSIVE PROBES

Increase input resistance to 10 megohms and decrease input capacitance to approx 7 pF. Risetime of Type 580-Series Oscilloscope with Type 82 Plug-In Unit and P6008 Probe, at an overall deflection factor of 1 V/cm is 5 ns.

INPUT RC

1 megohm paralleled by approx 15 pF.

MAXIMUM INPUT VOLTAGE

600 V combined DC + peak AC.

WEIGHTS

Net weight	5 lb	2.3 kg
Domestic shipping weight	≈10 lb	≈4.5 kg
Export-packed weight	≈14 lb	≈6.4 kg



INCLUDED STANDARD ACCESSORIES

Two P6008 probes (010-0129-00); two instruction manuals (070-0349-01).

OPTIONAL ACCESSORIES

Optional accessories increase measurement capability and provide added convenience. The standard probe supplied with the instrument satisfies most measurement requirements; optional probes, including high-voltage and current-measuring probes, may be better suited for particular applications. See catalog accessory pages for additional information on these and other items.

PROBES

P6009 100X Passive Probe Package, order 010-0140-00

P6011 1X Passive Probe Package, order 010-0193-00

MODIFICATION FOR EARLY INSTRUMENTS

TYPE 581/585 VERTICAL STANDARDIZATION MOD KIT improves and standardizes the transient response of early Type 580-Series Oscilloscopes. The Mod Kit is essential for the use of Type 82 or Type 86 Plug-In Unit in the early instruments and also improves the performance of these instruments when used with the Type 80/P80 combination.

Tektronix Type 580-Series Oscilloscopes with serial numbers prior to #950 for Type 581 and #2585 for Type 585 may require this modification. Please consult your Field Engineer or Distributor.

Each kit includes components to change delay-line impedance, standardize CRT termination, modify CRT and distributed amplifier circuitry, and modify Type 80/P80 combination. Order 040-0275-01

TYPE 86

SINGLE-TRACE UNIT

- 10 mV/cm DEFLECTION FACTOR
- DC TO 80 MHz AT 100 mV/cm
- DC TO 75 MHz AT 10 mV/cm

The Type 86 Plug-In Unit provides fast-rise capability, a calibrated deflection-factor range of 100 mV/cm to 50 V/cm and a built-in X10 amplifier which extends the deflection-factor range to 10 mV/cm. A P6008 Probe is supplied with the Type 86; other probes are available as optional accessories.

BANDWIDTH AND RISE TIME

Bandwidth figures are at 3-dB down and apply to calibrated and uncalibrated deflection factors.

WITHOUT PROBE (Source impedance approx 25 ohms)			
DEFLECTION FACTOR	DC-COUPLED BANDWIDTH	AC-COUPLED LOW-FREQUENCY 3-dB POINT	RISE TIME
X1 GAIN 100 mV to 50 V/cm	DC to 80 MHz	2 Hz	4.4 ns
X10 GAIN 10 mV to 5 V/cm	DC to 75 MHz	2 Hz	4.7 ns
WITH P6008 10X PROBE			
X1 GAIN 1 V to 500 V/cm	DC to 70 MHz	0.2 Hz	5 ns
X10 GAIN 100 mV to 50 V/cm	DC to 66 MHz	0.2 Hz	5.3 ns

DEFLECTION FACTOR

100 mV/cm to 50 V/cm in 9 calibrated steps (1-2-5 sequence), accurate within 3%. 2:1 variation, uncalibrated between steps and to approx 100 V/cm.

X10 AMPLIFIER

DC coupled, extends deflection factor to 10 mV/cm. Operates at all deflection-factor settings, accurate within 3%.

P6008 10X PASSIVE PROBE

Increases input resistance to 10 megohms and decreases input capacitance to approx 7 pF. Risetime of Type 580-Series Oscilloscope with Type 86 Plug-In Unit and P6008 Probe, at an overall deflection factor of 1 V/cm, is 5 ns.

INPUT RC

1 megohm paralleled by approx 15 pF.

MAXIMUM INPUT VOLTAGE

600 V combined DC + peak AC.

WEIGHTS

Net weight	3½ lb	1.6 kg
Domestic shipping weight	≈ 8 lb	≈ 3.6 kg
Export-packed weight	≈ 12 lb	≈ 5.5 kg

INCLUDED STANDARD ACCESSORIES

P6008 Probe (010-0129-00); two instruction manuals (070-0364-01).



OPTIONAL ACCESSORIES

Optional accessories increase measurement capability and provide added convenience. The standard probe supplied with the instrument satisfies most measurement requirements; optional probes, including high-voltage and current-measuring probes, may be better suited for particular applications. See catalog accessory pages for additional information on these and other items.

PROBES

- P6009 100X Passive Probe Package, order 010-0140-00
- P6011 1X Passive Probe Package, order 010-0193-00

MODIFICATION FOR EARLY INSTRUMENTS

TYPE 581/585 VERTICAL STANDARDIZATION MOD KIT improves and standardizes the transient response of early Type 580-Series Oscilloscopes. The Mod Kit is essential for the use of a Type 82 or 86 Plug-In Unit in the early instruments and also improves the performance of these instruments when used with the Type 80/P80 combination.

Tektronix Type 580-Series Oscilloscopes with serial numbers prior to #950 for Type 581 and #2585 for Type 585 may require this modification. If in doubt about instrument modification, please consult your Field Engineer or Distributor.

Each kit includes components to change delay-line impedance, standardize CRT termination, modify CRT and distributed-amplifier circuitry and modify Type 80 Plug-In Unit/Type P80 Probe combination.
Order 040-0275-01

Please refer to Terms and Shipment, General Information page.

5-INCH STORAGE DISPLAY UNIT

NEW



CHARACTERISTIC SUMMARY

VERTICAL AND HORIZONTAL

CALIBRATED DEFLECTION FACTOR—1-V full-screen deflection X and Y axis.

INFORMATION STORAGE RATE—100 thousand dots per second.

Z AXIS

TURN-ON LEVEL—+1 V or greater.

TURN-OFF LEVEL—+0.5 V or less.

INPUT RC—100 k Ω paralleled by 50 pF.

STORAGE CRT

DISPLAY AREA—Vertical—8 cm, Horizontal—10 cm.

RESOLUTION—Vertical—100 stored line pairs, Horizontal—125 stored line pairs.

ERASE TIME—200 ms.

DOT WRITING TIME—9 μ s.

OTHER

REMOTE CONTROL OF ERASE AND NON-STORE

POWER REQUIREMENTS—90 to 136 or 180 to 272 VAC, 48 to 440 Hz, 55 watts.

- **NON-FADING BISTABLE STORAGE**
- **1-V FULL-SCALE DEFLECTION FACTOR FOR VERTICAL AND HORIZONTAL AMPLIFIERS**
- **REMOTE PROGRAMMING OF DISPLAY FUNCTIONS**
- **ALL SOLID-STATE DESIGN**

The Type 601 Storage Display Unit permits stored, non-fading displays of combined alphanumeric and graphic information from digital computers and other data transmission systems. The Tektronix-developed bistable Storage CRT used in the Type 601 eliminates the need for costly memory devices for refreshing the information display. The built-in vertical and horizontal amplifiers permit Y versus T plots up to 100 kHz for remote storage monitor applications. All solid-state modular circuit design insures long-term stable performance.

TYPE 601



Stored display of standard ASCII character sets.

OPERATING FUNCTIONS

The Erase and Non-Store operating functions are remotely programmable through contacts at the remote program connector on the rear panel. An Erase Interval signal is also provided at this connector. X, Y, Z inputs are provided through rear BNC connectors or the remote program connector. Manual control of Erase and Power On-Off is provided on the front panel. A "ready-to-write" mode is established by erasing the CRT manually or remotely. Remote programming of the Type 601 is achieved by grounding the appropriate contacts at the rear program connector. The Intensity, Focus, Astigmatism, and Operating Level Controls are located behind the front access door for convenience of the operator.

VERTICAL AND HORIZONTAL AMPLIFIERS

DEFLECTION FACTOR

Vertical—1 V for 8-cm deflection, adjustable from 0.75 V to 1.1 V using internal controls.

Horizontal—1 V for 10-cm deflection, adjustable from 0.9 V to 1.1 V using internal controls.

With Attenuation Resistors—Up to 150-V full screen can be obtained by adding attenuation resistors to input circuits.

PHASE SHIFT

Not more than 1° between X and Y up to 100 kHz.

Y-T DISPLAYS

Useful to 100 kHz for displaying waveforms on a Y versus T plot.

INITIAL BEAM POSITION

Positioned by internal adjustment to any point on the screen. Position drift is not more than 1 mm/h after 20-min warm-up.

POLARITY

Positive input to the vertical and horizontal inputs moves the beam up and to the right.

LINEARITY

The voltage required to produce a 2-cm deflection at any point on the CRT will not vary more than 5%.

MAXIMUM INPUT VOLTAGE

±50 V combined DC and Peak AC.

INPUT RC

100 kΩ paralleled by approx 50 pF.

Z AXIS

The Z-axis on-time should be at least 9 μs to insure good storage of each written dot. The Z-axis pulse should be timed so that the system settling time is completed before unblanking occurs.

INPUT

Turn-on level (unblanked) is +1 V. Turn-off level (blanked) is +0.5 V or less. Recommended source impedance for driving the Z-axis is 1 kΩ or less.

MAXIMUM INPUT VOLTAGE

±50 V combined DC and peak AC.

INPUT RC

100 kΩ paralleled by approx 50 pF.

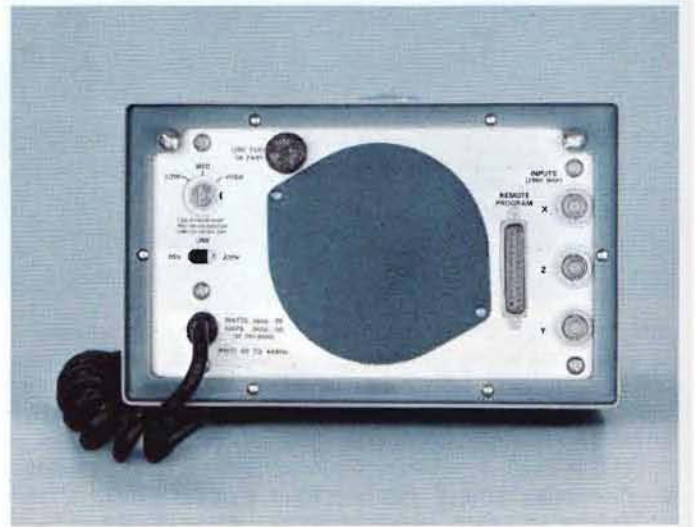

Rear panel of Type 601 Storage Display Unit.

CRT DISPLAY AND STORAGE

TEKTRONIX CRT

5-inch flat-faced bistable storage tube, phosphor similar to P1.

DISPLAY SIZE

8 cm vertically and 10 cm horizontally.

STORED LUMINANCE

At least 3 foot-lamberts.

CONTRAST RATIO

3:1 or greater.

DISPLAY LINEARITY

HORIZONTAL—No more than 5% difference between any two cm.

VERTICAL—No more than 2% difference between any two cm.

RESOLUTION

100 stored line pairs along the vertical axis. 125 stored line pairs along the horizontal axis.

TYPE 601

LINE WRITING SPEED (STORED)

At least 5 cm/ms (at specified resolution).

DOT WRITING TIME

9 μ s is required to write (store) one bit of information.

INFORMATION STORAGE RATE—100 thousand dots per sec.

VIEWING TIME

Up to 15 min recommended. Longer times may be obtained; however, erasure of previously stored information becomes more difficult.

ERASE TIME

200 ms is required to clear screen of stored information.

OTHER CHARACTERISTICS

POWER REQUIREMENTS

90 to 136 VAC or 180 to 272 VAC, 48 to 440 Hz, 55 watts maximum at 115 V and 60 Hz. Rear panel selector provides rapid accommodation for six line-voltage ranges.

DIMENSIONS AND WEIGHT

Height	5 $\frac{1}{4}$ in	13.4 cm
Width	8 $\frac{1}{2}$ in	20.6 cm
Depth	17 in	45.7 cm
Net Weight	21 lb	9.5 kg

INCLUDED STANDARD ACCESSORIES

Connector (131-0570-00), connector cover (200-0821-00), 3 to 2-wire adapter (103-0013-00), two instruction manuals (070-0747-00).

TYPE 601 MOD 146B

Standard instrument, less cabinet, for mounting in rack adapter.

OPTIONAL ACCESSORIES

Optional accessories serve to extend the usefulness of the Type 601 in certain applications.

RACK ADAPTER

For mounting two Type 601's side-by-side in a standard 19-inch rack, order 016-0115-00

PANEL ASSEMBLY

For covering $\frac{1}{2}$ of rack adapter when only one Type 601 is rackmounted, order 016-0116-00

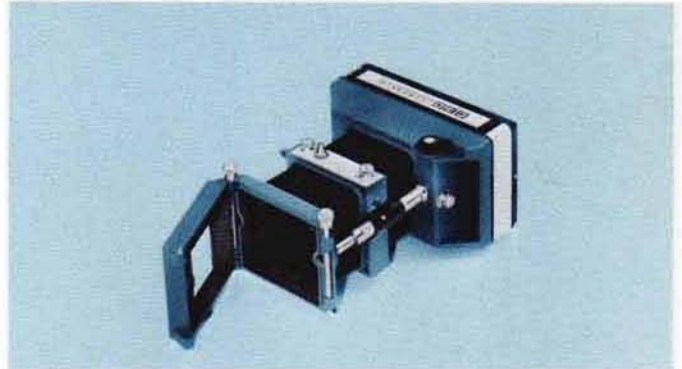

C-30 CAMERA

f/1.9 lens, magnification variable from 1.5:1 to 0.7:1; Polaroid Land* Pack-film back

Type 601 to C-30 Camera adapter, order 016-0248-00



C-30 CAMERA CARRYING CASE

Constructed of heavy-gage, high-impact plastic, has foam-backed, vacuum-formed styrene liner. Holds C-30 Camera, all standard accessories and extra film.

Order 016-0092-00

*Registered Trade-Mark, Polaroid Corporation.

Please refer to Terms and Shipment, General Information page.

TYPE 611

11-INCH STORAGE DISPLAY UNIT

NEW

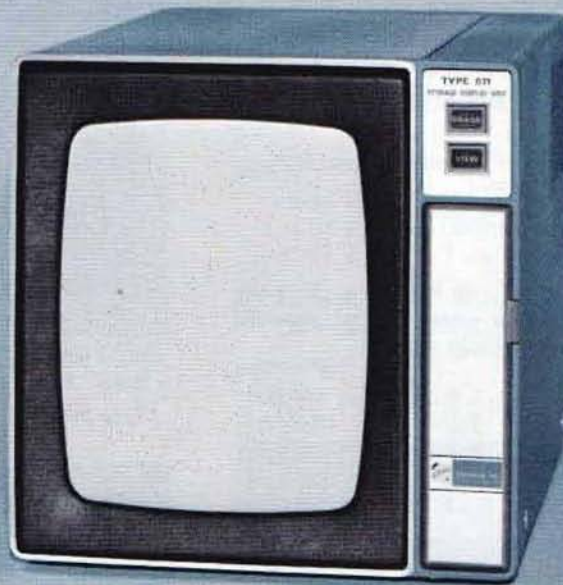

- **FLICKER-FREE DISPLAYS**
- **HIGH RESOLUTION ALPHANUMERIC AND GRAPHICS DISPLAY CAPABILITIES**
- **WRITE-THROUGH ABILITY**
- **REMOTE PROGRAMMING OF DISPLAY FUNCTIONS**

The Type 611 Storage Display Unit permits stored displays of combined alphanumeric and graphic information from digital computers and other data transmission systems. The Tektronix-developed bistable Storage CRT used in the Type 611 eliminates the need for costly memory devices for refreshing the information display and provides high information density without flicker and with excellent resolution. A write-through feature provides the operator the ability to visually position the writing beam to any point on the CRT display area without disturbing previously stored information. All solid-state circuit design insures long-term stable performance. The vertical format display area provides the same aspect ratio as a typewritten page.

CHARACTERISTIC SUMMARY

VERTICAL AND HORIZONTAL

CALIBRATED DEFLECTION FACTOR—1-V full screen deflection X and Y axis.

SETTLING TIME— $3.5 \mu\text{s}/\text{cm} + 5 \mu\text{s}$.

Z AXIS

TURN-ON LEVEL—+1 V or greater.

TURN-OFF LEVEL—+0.5 V or less.

INPUT RC—100 k Ω paralleled by 50 pF.

STORAGE CRT

DISPLAY AREA—Vertical—21 cm, Horizontal—16.3 cm. 25% storable.

RESOLUTION—Equivalent to 400 stored line pairs along the vertical axis; 300 stored line pairs along the horizontal axis.

ERASE TIME—0.5 seconds.

DOT WRITING TIME—20 μs

OTHER

REMOTE CONTROL OF ERASE, NON-STORE, VIEW AND WRITE-THROUGH

POWER REQUIREMENTS—90 to 136 or 180 to 272 VAC, 48 to 66 Hz, 250 watts.

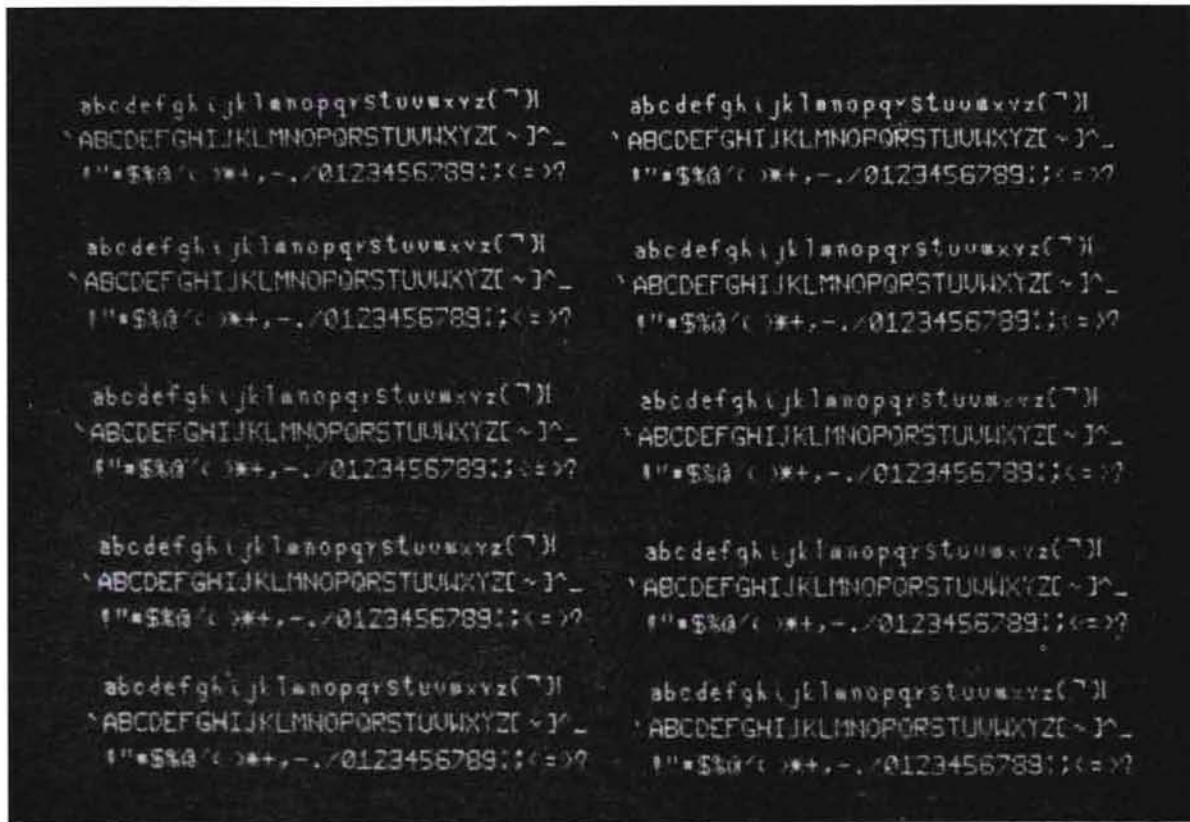

Stored display of standard ASCII character sets. Upper 1/2 of screen is shown (near actual size).

OPERATING FUNCTIONS

The Erase, Non-Store, Write-Through and View operating functions are remotely programmable through contacts at the remote program connector on the rear panel. An Erase Interval signal is also provided at this connector. X, Y, Z inputs are provided through rear BNC connectors or the remote program connector (optional). Manual control of Erase and View is provided on the front panel. Remote programming of the Type 611 is achieved by grounding the appropriate contacts at the rear program connector. The remote switching device must be capable of switching +10 V to approx ground (+0.5 V to -10 V) and handle up to 5 mA of current.

A "ready-to-write" mode is established by erasing the CRT. When the new information has been written, the instrument will be in the "view" mode for approximately one minute and will then automatically switch to the "hold" mode. This holds information stored on the CRT at a low brightness to improve CRT life. Pressing the VIEW switch while in the "hold" mode returns instrument to the "view" mode for approximately 1 minute.

A special "write-through" feature is provided and is programmed through the rear-panel program connector. When the program contact is closed the CRT beam is unblanked if Z-axis is activated, and "viewed" without destroying previously stored information, and without storing new information. A combination of reduced beam current and beam movement to form a circular small diameter Lissajous pattern prevents storage.

The Intensity, Focus, Operating Level, Power Switch and Test Spiral controls are located behind a front-panel access door. Pushing the Test Spiral switch causes the instrument to complete an erase cycle and store a single-shot test pattern presentation. Pulling TEST SPIRAL switch provides a "non-store" mode with repetitive test pattern for focusing and other tests.

VERTICAL AND HORIZONTAL AMPLIFIERS

DEFLECTION FACTOR

Vertical—1-V full scale (16.3 cm for square format or 21 cm for rectangular format), accuracy within 2%.

Horizontal—1-V full scale (16.3 cm), accuracy within 2%.

With Attenuation Resistors—Up to 75-V full screen for vertical or horizontal deflection can be obtained by adding attenuation resistors to input circuits.

INITIAL BEAM POSITION

Any one of 9 initial beam positions can be selected by internal switches. Each position is adjustable $\pm 10\%$ of full scale both vertically and horizontally.

SETTLING TIME

3.5 $\mu\text{s}/\text{cm}$ + 5 μs , to within 1 spot diameter of final position.

POLARITY

Positive input to the vertical and horizontal inputs moves the beam up and to the right.

LINEARITY

The voltage required to produce a 2-cm deflection at any point on the CRT will not vary more than 10%.

MAXIMUM INPUT VOLTAGE

± 50 V combined DC and peak AC.

INPUT RC

100 k Ω paralleled by approx 60 pF.

POSITIONAL STABILITY

$\pm 0.1\%$ or less of full scale/hour with 75- Ω source impedance at 20°C to 30°C. Within $\pm 0.5\%$ of full scale/hour with 75- Ω source impedance at 0°C to 50°C. Reference 25°C.

TYPE 611

Z-AXIS

INPUT

Turn-on level (unblanked) is +1 V. Turn-off level (blanked) is +0.5 V.

MAXIMUM INPUT VOLTAGE

±50 V combined DC and peak AC.

INPUT RC

100 kΩ paralleled by approx 50 pF.



Rear panel of Type 611 Storage Display Unit.

CRT DISPLAY AND STORAGE

TEKTRONIX CRT

11-inch flat-faced bistable storage tube, phosphor similar to P1.

DISPLAY SIZE

Vertically—21 cm (approx $8\frac{5}{32}$ in), Horizontally—16.3 cm (approx $6\frac{7}{16}$ in). Display area is up to 25% incrementally storable.

STORED LUMINANCE

At least 3 foot-lamberts.

CONTRAST RATIO

3:1 or greater.

RESOLUTION

4,000 characters based on a 90 x 70 mil matrix, clearly legible with good spacing. Equivalent to 400 vertical x 300 horizontal stored line pairs. (Resolution is measured using 400 x 300 stored dots since closely spaced line pairs exceed 25% incremental storage.)

VIEWING TIME

Less than 15 min recommended. Viewing time may be longer; however, erasure of previously stored information becomes more difficult.

ERASE TIME

0.5 seconds to clear screen of stored information.

DOT WRITING TIME

20 μ s is required to write (store) one bit of information.

OTHER CHARACTERISTICS

ERASE INTERVAL PULSE

A negative-going erase pulse is provided at the rear program connector to inhibit external equipment during an erase cycle. Amplitude is approx 10 V, source impedance approx 2 kΩ.

POWER REQUIREMENTS

90 to 136 VAC or 180 to 272 VAC, 48 to 66 Hz, 250 watts maximum at 115 V and 60 Hz. Rear panel selection provides rapid accommodation for six line-voltage ranges.

DIMENSIONS AND WEIGHT

Height	11 $\frac{7}{8}$ in	30.1 cm
Width	11 $\frac{5}{8}$ in	29.5 cm
Depth	22 $\frac{3}{8}$ in	56.8 cm
Net Weight	50 lb	22.7 kg

INCLUDED STANDARD ACCESSORIES

External program connector (131-0570-00); connector cover (200-0821-00); 3 to 2 wire adapter (103-0013-00); two instruction manuals (070-0752-00).

Please refer to Terms and Shipment, General Information page.

DC-to-100 MHz OSCILLOSCOPES



- **DC-to-100 MHz BANDWIDTH WITH OR WITHOUT PROBES**
- **BUILT FOR SEVERE ENVIRONMENTS**
- **HIGH WRITING SPEED**
- **ILLUMINATED NO-PARALLAX GRATICULE**
- **6 x 10-cm DISPLAY**
- **SOLID-STATE DESIGN**

The Type 647A and R647A are compact, high-performance instruments capable of accurate measurements over an ambient temperature range from -30°C to $+65^{\circ}\text{C}$. Accuracy is even better in normal ambient temperatures ranging from 0°C to $+40^{\circ}\text{C}$.

The Type 647A and R647A Oscilloscopes offer bandwidths from DC to 100 MHz with or without probes when used with the Type 10A2A Dual-Trace Plug-in Unit. Triggering over the entire 100-MHz bandwidth is possible with a Type 11B2A Sweep-Delay Time-Base Unit.

An accelerating potential of 14 kV provides a small, bright CRT spot with corresponding high writing speed. An internal, 6 x 10-cm graticule with variable illumination offers parallax-free measurements.

A quick-change line-voltage selector permits simple and convenient adaptation to 6 different line-voltage ranges.

CHARACTERISTIC SUMMARY

VERTICAL

Two vertical plug-in units are available: Type 10A1 Differential Amplifier featuring voltage-comparator capability, and Type 10A2A Dual-Trace Amplifier with 100-MHz bandwidth. Operating modes of Type 10A2A include CH 1, CH 2, ALTERNATE, CHOP ($\approx 1\text{-MHz}$ rate), and ADD.

HORIZONTAL

Two time-base plug-in units are available: Type 11B1 with single time base and direct reading magnifier, and Type 11B2A with dual time bases and sweep delay; both units equipped with single sweep for photographic recording.

CRT

DISPLAY AREA—6 x 10 cm

ACCELERATING VOLTAGE—14 kV

PHOSPHOR—P31

OTHER

AMPLITUDE CALIBRATOR—0.2 mV to 100 V, 1-kHz square-wave.

POWER REQUIREMENT—90 V to 136 V and from 180 V to 272 V in six ranges; range selection accomplished by quick-change, switching device. Maximum power approx 200 watts at 115 V and 60 Hz. Type 647A: 45 to 440 Hz, Type R647A: 45 to 66 Hz.

TYPE **647A** **R647A**

VERTICAL DEFLECTION

BANDWIDTH AND RISE TIME

Bandwidth figures are at 3-dB down.

PLUG-IN	DEFLECTION FACTOR	BANDWIDTH*		RISE TIME	
		0°C to +40°C	-30°C to +65°C	0°C to +40°C	-30°C to +65°C
10A1	5 mV/cm to 20 V/cm	55 MHz	50 MHz	6 ns	7 ns
	1 mV/cm and 2 mV/cm	35 MHz	35 MHz	10 ns	10 ns
10A2A	10 mV/cm to 20 V/cm	100 MHz	90 MHz	3.5 ns	3.9 ns

*Stated frequencies are upper bandwidth limits. Lower limit is DC (when DC coupled). With AC coupling, low-frequency 3-dB down point is ≈ 1.6 Hz without probe, or ≈ 0.16 Hz with P6047 10X Probe.

SIGNAL DELAY

Permits observation of the leading edge of the waveform that triggers the sweep. Delay line requires no tuning.

HORIZONTAL DEFLECTION

Two Time-Base Plug-In Units are available for use with the Type 647A and R647A Oscilloscopes.

PLUG-IN UNIT	CALIBRATED RANGE	SWEEP MAGNIFIER	SWEEP SYSTEM
Type 11B1	0.1 μ s/cm to 2 s/cm	Direct reading up to X50, 10 ns/cm max	Single Time Base Generator
Type 11B2A	0.1 μ s/cm to 5 s/cm	X10, Extends Range to 10 ns/cm	Dual Time Base Generator with Sweep Delay

Both plug-in units have single-sweep and external-horizontal-amplifier capability.

CRT

TEKTRONIX CRT

Rectangular, flat-faced CRT. 14-kV accelerating potential for bright displays. P31 phosphor normally supplied.

GRATICULE

No-parallax, 6 x 10-cm, internal graticule with variable edge illumination. Ruled in 1-cm divisions, vertical and horizontal centerlines further marked in 2-mm increments.

EXTERNAL CRT INPUTS

Input through unblanking amplifier to CRT grid with bandwidth from DC to 10 MHz; visible modulation with 4-V peak-to-peak signal. An additional input to CRT cathode is AC coupled; visible modulation with 5-V peak-to-peak signal.



ENVIRONMENTAL CAPABILITIES

TEMPERATURE

Operating: Type R647A: -30°C to $+65^{\circ}\text{C}$.

Type 647A: -30°C to $+65^{\circ}\text{C}$, continuous, when instrument is not tipped more than 20° in any direction from level position. When instrument is operated vertically (with front panel up), the maximum ambient temperature is $+55^{\circ}\text{C}$. Non-operating: -55°C to $+75^{\circ}\text{C}$.

VIBRATION*

Operating: 0.025 inch peak to peak, 10 to 55 to 10 c/s in 1 minute sweeps (4 g at 55 c/s) for 15 minutes on each axis.

ALTITUDE

Operating: 15,000 feet maximum. Maximum operating temperature of the Type 647A reduced to $+55^{\circ}\text{C}$ at 15,000 feet. Non-operating: 50,000 feet, maximum.

SHOCK

Non-operating: 20 G's, one-half sine, 11-millisecond duration. Two shocks each direction along each of the three major axes; total of 12 shocks.

HUMIDITY

Non-operating: Meets electrical performance specifications after exposure to five cycles (120 hours) of Mil-Std-202B, method 106A (omit freezing and vibration, and allow 24-hour post-test drying period before operating).

TRANSPORTATION

Meets National Safe Transit test when factory-packaged: Vibration for one hour at slightly greater than one G. Drop on any corner, edge or flat surface; 18-in drop for Type R647A, 30-in drop for Type 647A.

*Applicable to R647A when mounted in a rack with rear support kit 016-0065-00.

OTHER CHARACTERISTICS

AMPLITUDE CALIBRATOR

0.2 mV to 100 V in 18 calibrated steps (1-2-5 sequence), 1-kHz squarewave. Crystal-controlled frequency accurate within 0.1% from -30° C to +65° C. Output resistance 50 Ω from 0.2 mV to 0.2 V. Squarewave duty cycle 49.9% to 50.1%. Risetime ≤ 1 μs. For current-probe calibration, a 5-mA squarewave is available through a front-panel current loop. The calibrator also provides a 100-V DC output.

AMPLITUDE ACCURACY	0° C to +40° C	-30° C to +65° C
100 V and 100 mV	±1%	±1.5%
All other positions	±2%	±3%

POWER REQUIREMENTS

Quick-change line-voltage selector permits selection of the following ranges: 90 V to 110 V, 104 V to 126 V, 112 V to 136 V, 180 V to 220 V, 208 V to 252 V, or 224 V to 272 V. Approx 200 watts maximum at 115 V and 60 Hz. Type 647A: 45 to 440 Hz. Type R647A: 45 to 66 Hz.

TYPE 647A DIMENSIONS AND WEIGHTS

Height	14 ⁵ / ₈ in	37.1 cm
Width	9 ⁷ / ₈ in	25.2 cm
Depth	22 in	56.0 cm
Net weight	40 lb	17.8 kg
Domestic shipping weight	≈49 lb	≈21.9 kg
Export-packed weight	≈62 lb	≈27.6 kg

TYPE R647A DIMENSIONS AND WEIGHTS

Height	7 in	17.8 cm
Width	19 in	48.3 cm
Rack depth	19 in	48.3 cm
Net weight	50 lb	22.2 kg
Domestic shipping weight	≈73 lb	≈32.4 kg
Export-packed weight	≈96 lb	≈42.6 kg

INCLUDED STANDARD ACCESSORIES

Two P6047 Probes (010-0211-00); smoke-gray filter, installed (378-0548-00); 8-in, 93-Ω cable, BNC to BNC (012-0123-00); clear implosion shield (337-0573-00); 18-in patch cord, BNC to BNC (012-0087-00); 18-in patch cord, BNC to banana plug (012-0091-00); BNC post jack (012-0092-00); 3 to 2-wire adapter

(103-0013-00); 6-in patch cord, BNC to BNC (012-0085-00); 2 red butyrate graticule-light insert (377-0105-00); Type 647A: two instruction manuals (070-0614-00); Type R647A: two instruction manuals (070-0627-00); set mounting tracks and hardware (351-0085-00); rackmount rear support kit (016-0065-00); hardware kit (016-0099-00).

OPTIONAL ACCESSORIES

Optional accessories increase measurement capability and provide added convenience. The standard probe supplied with the instrument satisfies most measurement requirements; optional probes, including high-voltage and current-measuring probes, may be better suited for particular applications. See catalog accessory pages for additional information on these and other items.

REAR-PANEL CONNECTOR

10-pin connector for remote single-sweep reset and external use of power-supply voltages. Order 131-0300-00

C27-662 R CAMERA

Equipped with a special lens to permit single-sweep photography of oscilloscope displays at fast writing speeds. 1:05, f/1.3 lens, Polaroid Land* roll-film back.

Mounting Adapter, order 016-0223-00

PROBES

P6023 10X Low-Capacitance Probe for use with Tektronix differential amplifiers.
Order P6023 PROBE PACKAGE (010-0167-00 LOCKING BNC)

SCOPE-MOBILE® CART

Model 201-2: Storage drawer, carrier for two plug-in units, 9-position tilt-lock oscilloscope tray.

*Registered Trade-Mark Polaroid Corporation

Please refer to Terms and Shipment, General Information page.

TYPE 10A1

DC-TO-55 MHz

DIFFERENTIAL UNIT

- **1 mV/cm to 20 V/cm CALIBRATED DEFLECTION FACTOR**
- **1000:1 COMMON-MODE REJECTION FROM DC to 10 MHz**
- **EQUIVALENT OFFSET VOLTAGE UP to ± 600 V PROVIDES 4-DIGIT RESOLUTION FOR ACCURATE AMPLITUDE MEASUREMENTS**

The Type 10A1 combines the features of a conventional amplifier, a differential amplifier, and a calibrated differential comparator in a single plug-in unit for Type 647A and R647A Oscilloscopes. Rapid recovery from large differential overload allows detailed study of pulse-top flatness as well as comparator measurement of transient amplitudes. The effective 6,000-cm slide-back scale and 20,000:1 common-mode rejection ratio permit accurate measurements and comparisons. Rugged design insures accuracy over the same range of environmental conditions as stated for Type 647A and R647A Oscilloscopes.

CONVENTIONAL AMPLIFIER

BANDWIDTH AND RISE TIME

Bandwidth is specified at 3-dB down. Bandwidth may be limited to 1 MHz $\pm 10\%$, when desired, for noise reduction at higher sensitivities. AC coupling provides a low-frequency 3-dB point at ≈ 1.6 Hz. Use of the P6047 10X probe with AC coupling extends the low-frequency 3-dB point to 0.16 Hz.

BANDWIDTH AND RISE TIME WITH OR WITHOUT P6047 10X PROBE		
DEFLECTION FACTOR	0° C to +40° C	-30° C to +65° C
5 mV/cm to 20 V/cm	55 MHz and 6 ns	50 MHz and 7 ns
1 mV/cm and 2 mV/cm	35 MHz and 10 ns	35 MHz and 10 ns

MAXIMUM INPUT VOLTAGE

Maximum combined DC and Peak AC is ± 20 V when using 1 mV/cm to 20 mV/cm deflection factors, ± 600 V when using the 50 mV/cm to 20 V/cm deflection factors.

DEFLECTION FACTOR

1 mV/cm to 20 V/cm in 14 calibrated steps (1-2-5 sequence). Continuously variable (uncalibrated) between steps and to approx 50 V/cm. Deflection factor can be calibrated at any step with front-panel GAIN adjustment. When GAIN has been accurately adjusted at 5 mV/cm, accuracies are as follows:



VOLTS/CM ACCURACY		
	0° C to +40° C	-30° C to +65° C
DEFLECTION FACTOR		
1 mV/cm (also 10 mV/cm and 0.1 V/cm with Vc range extended)	$\pm 2.5\%$	$\pm 4\%$
2 mV/cm through 2 V/cm (except 10 mV/cm and 0.1 V/cm with Vc range extended)	$\pm 1.5\%$	$\pm 2.5\%$
5 V/cm through 20 V/cm	$\pm 3\%$	$\pm 4\%$

INPUT RC

1 megohm paralleled by 20 pF.

DIFFERENTIAL AMPLIFIER

COMMON-MODE REJECTION RATIOS

Values stated apply at a deflection factor of 1 mV/cm and from 0° C to +40° C.

COMMON-MODE REJECTION DC COUPLED		
FREQUENCY RANGE	REJECTION RATIO	RANGE OF PEAK-TO-PEAK INPUT SINEWAVE
DC to 100 kHz	20,000:1	0 V to 10 V
100 kHz to 1 MHz	10,000:1	0 V to 10 V
1 MHz to 10 MHz	10,000:1* divided by freq in MHz	0 V to 10 V* divided by freq in MHz
20 MHz	100:1	0 V to 1 V
AC COUPLED		
60 Hz	2,000:1	0 V to 10 V

*Divide CMRR and voltage by the frequency in MHz; e.g., at 2 MHz the CMRR is 5,000:1 up to 5 V input amplitude.

At 10 mV/cm, using the internal 10X attenuator, CMRR is 2,000:1 for 20-V peak-to-peak 10 kHz sinewave.

RECOVERY TIME

$\leq 0.5 \mu\text{s}$ for a return to within $\pm 2 \text{ mV}$ after differential offset. Recovery DC error $\leq 0.5 \text{ mV}$ after 1-ms recovery time. Characteristics apply from 0° C to $+40^\circ \text{ C}$.

CALIBRATED DIFFERENTIAL COMPARATOR

Comparison Voltage (V_c) can be used to offset the input waveform via the slide-back technique. The internal V_c source allows measurement, with 4-digit resolution, of signal amplitudes up to $\pm 600\text{-V}$. Equivalent V_c range is normally selected simultaneously with deflection factor, but may be extended for two additional steps. Bandwidth and risetime in the extended V_c positions are the same as at 1 and 2 mV/cm.

INPUT VOLTAGE		
DEFLECTION FACTOR	LINEAR DYNAMIC RANGE and EQUIVALENT V_c RANGE	MAXIMUM COMBINED DC AND PEAK AC
1 mV/cm through 20 mV/cm	$\pm 6 \text{ V}$	$\pm 20 \text{ V}$
10 mV/cm through 0.2 V/cm	$\pm 60 \text{ V}$	$\pm 600 \text{ V}$
0.1 V/cm through 20 V/cm	$\pm 600 \text{ V}$	$\pm 600 \text{ V}$

V_c CHARACTERISTICS			
EQUIVALENT V_c RANGE	SLIDEBACK MEASUREMENT ACCURACY		DEFLECTION FACTOR
	0° C to $+40^\circ \text{ C}$	-30° C to $+65^\circ \text{ C}$	
6 volts	$\pm(0.1\% + 5 \text{ mV})$	$\pm(0.15\% + 8 \text{ mV})$	1 mV/cm through 20 mV/cm
60 volts	$\pm(0.225\% + 50 \text{ mV})$	$\pm(0.4\% + 80 \text{ mV})$	10 mV/cm through 0.2 V/cm*
600 volts	$\pm(0.35\% + 0.5 \text{ V})$	$\pm(0.65\% + 0.8 \text{ V})$	0.1 V through 20 V/cm*

*Pull knob to retain V_c range at two lowest deflection factors.

V_c OUTPUT

Available at front panel as well as internally. Output continuously variable from 0 to $\pm 6 \text{ V}$ (0 to $\pm 0.6 \text{ V}$ when deflection factor is set at 5, 10, or 20 V/cm). Accuracy is within $\pm(0.1\% + 5 \text{ mV})$ from 0° C to $+40^\circ \text{ C}$ and within $\pm(0.15\% + 8 \text{ mV})$ from -30° C to $+65^\circ \text{ C}$. (Open circuit values).

V_c CHARACTERISTICS WITH P6023 PROBE			
EQUIVALENT V_c RANGE	SLIDEBACK MEASUREMENT ACCURACY		DEFLECTION FACTOR
	0° C to $+40^\circ \text{ C}$	-30° C to $+65^\circ \text{ C}$	
60 volts	$\pm(0.225\% + 50 \text{ mV})$	$\pm(0.4\% + 80 \text{ mV})$	10 mV/cm through 0.2 V/cm
600 volts	$\pm(0.5\% + 0.5 \text{ V})$	$\pm(0.95\% + 0.8 \text{ V})$	0.1 V/cm through 0.2 V/cm*
6000 volts**	$\pm(1\% + 5 \text{ V})$	$\pm(2\% + 8 \text{ V})$	1 V/cm through 200 V/cm*

*Pull knob to retain V_c range at two lowest deflection factors.

**Probe rating is 1000 volts maximum.

WEIGHTS

Net weight	$4\frac{3}{4} \text{ lb}$	2.2 kg
Domestic shipping weight	$\approx 9 \text{ lb}$	$\approx 4.1 \text{ kg}$
Export-packed weight	$\approx 13 \text{ lb}$	$\approx 5.9 \text{ kg}$

INCLUDED STANDARD ACCESSORIES

Two instruction manuals (070-0464-00).

OPTIONAL ACCESSORIES

Optional accessories increase measurement capability and provide added convenience. See catalog accessory pages for additional information.

PROBES

P6023 10X Low-Capacitance Probe for use with Tektronix differential amplifiers is provided with $\pm 2.5\%$ adjustability of attenuation ratio; helpful in maintaining common-mode rejection ratio of the system. Order P6023 PROBE PACKAGE (010-0167-00 LOCKING BNC)

Please refer to Terms and Shipment, General Information page.

TYPE 10A2A

DC-to-100 MHz DUAL-TRACE UNIT

- 3.5-ns RISETIME
- 10 mV/CM to 20 V/CM
- DUAL TRACE, 5 OPERATING MODES
- FRONT-PANEL CHANNEL-2 OUTPUT
- TRIGGER SELECTION

Bandwidth from DC to 100 MHz, at the probe tip, makes the Type 10A2A an especially versatile plug-in unit for the Type 647A and Type R647A Oscilloscopes. Two identical channels can be added algebraically, operated singly with either polarity, or operated dual trace with alternate or chopped switching. The Type 10A2A is built to meet the same environmental requirements as Type 647A and R647A Oscilloscopes.

BANDWIDTH

Without probe or with P6047 10X Probe: DC to 100 MHz (3-dB down) from 0°C to +40°C or DC to 90 MHz (3-dB down) from -30°C to +65°C. Low-frequency 3-dB point with AC coupling is ~1.6 Hz, ~0.16 Hz with 10X probe.

RISETIME

Without probe or with P6047 10X Probe: 3.5 ns from 0°C to +40°C or 3.9 ns from -30°C to +65°C.

DEFLECTION FACTOR

Without Probe: 10 mV/cm through 20 V/cm in 11 calibrated steps (1-2-5 sequence). After calibration at 0.01 V/cm, and at the operating temperature, deflection-factor accuracy is within 2% for the other 10 steps. Deflection factor can be calibrated at any step with front-panel GAIN adjustment. Deflection factor continuously variable (uncalibrated) between steps and to approx 50 V/cm. With P6047 10X Probe: All deflection factors multiplied by 10. Probe attenuation accurate within 2% from -30°C to +65°C.

MAXIMUM INPUT VOLTAGE

600 V, DC + peak AC (≤ 1 kHz). Peak-to-peak AC not to exceed 600 V.

INPUT RC

1 megohm paralleled by 20 pF.

CHOPPED MODE

Switches channels at 1 MHz ($\pm 15\%$) rate, displaying approx 500-ns segments of each channel. Chopped-transient blanking is provided.

CHANNEL INVERSION

The display of either channel can be inverted for comparing signals 180° out of phase.

ADDED MODE

Common-mode rejection ratio 20:1 in added-algebraically mode for frequencies to 50 MHz and amplitudes to 10 cm.

CHANNEL ISOLATION (ATTENUATOR)

10,000:1 or greater for frequencies to 25 MHz.

CHANNEL-2 OUTPUT

Front-panel output with amplitude ≥ 100 mV per centimeter of Channel-2 display. Can be connected to Channel 1 in cascade for overall deflection factor of approx 1 mV/cm and bandwidth from DC to 40 MHz (3-dB down).



INTERNAL TRIGGER

Selectable triggering from common output amplifier or from Channel 2 only. Triggering from Channel 2 provides common time relationship between channels in Alternate or Chopped operation.

WEIGHTS

Net weight	5¼ lb	2.4 kg
Domestic shipping weight	≈9 lb	≈4.1 kg
Export-packed weight	≈13 lb	≈5.9 kg

INCLUDED STANDARD ACCESSORIES

Two instruction manuals (070-0615-00).

OPTIONAL ACCESSORIES

The standard probe supplied with the Type 647A satisfies most measurement requirements. Optional probes, including high-voltage and current-measuring probes, may be better suited for particular applications. See catalog accessory pages for additional information on these and other items.

PROBES

P6011 1X Passive Probe Package, order 010-0193-00

P6009 100X Passive Probe Package, order 010-0170-00

Please refer to Terms and Shipment, General Information page.

TIME-BASE UNIT

- 10 ns/cm to 2 s/cm SWEEP RANGE
- DIRECT-READING MAGNIFIER
- 50 MHz TRIGGERING
- SINGLE-SWEEP OPERATION

The Type 11B1 is a Time-Base Plug-In Unit for Type 647A and R647A Oscilloscopes, and is built to meet the same environmental requirements. It features a single, wide-range sweep generator with a direct reading X1 to X50 magnifier. It provides normal sweeps to 0.1 μ s/cm and direct-reading magnified sweeps to 10 ns/cm.

TIME BASE

0.1 μ s/cm to 2 s/cm in 23 calibrated steps (1-2-5 sequence). Continuously variable (uncalibrated) between steps and to approx 5 s/cm. Free-run light warns the operator when sweep is not triggered.

DIRECT-READING MAGNIFIER

Up to X50 sweep expansion selected by TIME/CM switch.

ACCURACIES		
SWEEP RATES	0° C	-30° C
	to +40° C	to +65° C
0.1 μ s/cm to 50 ms/cm	$\pm 1.5\%$	$\pm 2.5\%$
0.1 s/cm to 2 s/cm	$\pm 3\%$	+4%, -6%
	Added by magnifier:	
10 ns/cm and 20 ns/cm	$\pm 2\%$	$\pm 2.5\%$
50 ns/cm to 1 s/cm	$\pm 1\%$	$\pm 1.5\%$

EXTERNAL INPUT

0.1 V/cm to 2 V/cm in 5 steps, accurate within 2%; or, using $\div 10$ input attenuator, 1 V/cm to 20 V/cm in 5 steps, accurate within 5%. Continuously variable (uncalibrated) between steps. DC to 3 MHz (3-dB down). Low-frequency 3-dB point 16 Hz with AC coupling, 17 kHz with AC low-frequency reject. Input RC approx 1 megohm paralleled by approx 35 pF (EXT) or approx 10 megohm and 6 pF (EXT $\div 10$).

SIGNAL OUTPUTS

+ Gate (approx 15 V) and positive-going sawtooth (approx 10 V) outputs via front-panel BNC connectors.

TRIGGER

MODES

Free-run, single-sweep, normal and 2 types of automatic baseline operation (manual or auto trigger level). Automatic baseline triggering is useful above 20 Hz and minimizes trigger adjustment for signals of different amplitudes, shapes and repetition rates. With no triggering signal, a recurring sweep provides a convenient reference trace.

AUTO-LEVEL AUTOMATIC OPERATION

Establishes triggering level near waveform average. Offers triggering convenience for most waveforms.



MANUAL-LEVEL AUTOMATIC OPERATION

Full operator control of triggering level for triggering on either + or - slope. Provides for effective triggering with small amplitude or low duty cycle signals.

COUPLING

DC, AC (3-dB down at approx 16 Hz) or AC LF Reject (3-dB down at approx 17 kHz).

SOURCES

Internal, external, external $\div 10$, or line. External trigger input RC approx 1 megohm paralleled by 35 pF (EXT) or 10 megohm and 6 pF (EXT $\div 10$).

REQUIREMENTS

2-mm deflection or 125-mV external from DC to 50 kHz, increasing to 1-cm deflection or 250-mV external at 50 MHz. Requirements applicable to normal triggering or automatic baseline, manual level.

HIGH-FREQUENCY STABILITY

Changes time-base recovery time to reduce high-frequency jitter.

OTHER

WEIGHTS

Net weight	4 $\frac{3}{4}$ lb	2.2 kg
Domestic shipping weight	≈ 8 lb	≈ 3.6 kg
Export-packed weight	≈ 13 lb	≈ 5.9 kg

INCLUDED STANDARD ACCESSORIES

Two instruction manuals (070-0424-00).

Please refer to Terms and Shipment, General Information page.

TYPE 11B2A

SWEEP DELAY TIME-BASE UNIT

- 10 ns/cm to 5 s/cm SWEEP RANGE
- VERSATILE TRIGGERING TO 100 MHz
- NORMAL AND DELAYED SWEEPS
- SINGLE SWEEP FOR PHOTOGRAPHIC RECORDING

The Type 11B2A is a Time-Base Plug-In Unit for Type 647A and R647A Oscilloscopes, and is built to meet the same environmental requirements. Two separate time-base generators and a calibrated sweep delay are provided. Time Base A is the normal sweep and is also used to delay the start of Time Base B.

TIME BASE A AND B

0.1 μ s/cm to 5 s/cm in 24 calibrated steps (1-2-5 sequence). Continuously variable (uncalibrated) between steps and to approx 12.5 s/cm.

X10 SWEEP MAGNIFIER

Operates over the full range of both time bases. Increases the fastest rate to 10 ns/cm.

ACCURACIES		
SWEEP RATES	0° C	-30° C
	to +40° C	to +65° C
0.1 μ s/cm to 50 ms/cm	$\pm 1.5\%$	$\pm 2.5\%$
0.1 s/cm to 5 s/cm	$\pm 3\%$	+4%, -6%
Added by X10 magnifier:		
10 ns/cm and 20 ns/cm	$\pm 2\%$	$\pm 2.5\%$
50 ns/cm to 0.5 s/cm	$\pm 1\%$	$\pm 1.5\%$

DELAY TIME

1 μ s to 50 s, continuously variable and calibrated.

DELAY ACCURACIES		
RANGE OR CHARACTERISTIC	0° C	-30° C
	to +40° C	to +65° C
1 μ s/cm to 50 ms/cm	$\pm 1.0\%$ ID	+2% ID
0.1 s/cm to 5 s/cm	$\pm 2.5\%$ ID	+3%, -6% ID
Multiplier Incremental	$\pm 0.15\%$ FS	$\pm 0.2\%$ FS
Linearity	$\pm 0.15\%$ FS	$\pm 0.2\%$ FS
Jitter	Less than 1 part in 20,000 of maximum available delay	

ID—% of indicated delay.

FS—% of full scale (10X TIME/cm or DELAY TIME setting). For absolute delay from trigger point to delay start, trigger processing time (typically 100 ns) must be added.



OPERATING MODES

A only, A intensified by B, B delayed by A. In the two latter modes, B can be started automatically at the end of A, or is triggerable following the end of the delay period (providing a steady display of time-modulated pulses and signals with inherent jitter).

EXTERNAL INPUT

1 V/cm $\pm 10\%$ without magnification or 0.1 V/cm $\pm 10\%$ with X10 magnifier. Bandwidth is DC to 3 MHz (3-dB down). Low-frequency 3-dB point is 16 Hz with AC coupling. Input RC is 1 megohm paralleled by approx 30 pF.

SIGNAL OUTPUTS

Positive gates (approx 15 V) and positive-going sawtooths (approx 10 V) from both time bases.

TRIGGER

MODES

Normal, automatic, single-sweep, or free-run on Time Base A. Automatic operation is useful between approx 20 Hz and 100 MHz, minimizes trigger adjustments for signals of different amplitudes, shapes and repetition rates. With no input (or input less than 20 Hz), a recurring sweep provides a convenient reference trace.

COUPLING

AC, AC Low-frequency reject, or DC on Time Base A.

TYPE 11B2A

SOURCES

Internal source selected from oscilloscope vertical amplifier, external, external $\div 10$, or line. External trigger input RC approx 1 megohm paralleled by approx 25 pF (EXT) or 10 megohm and 5 pF (EXT $\div 10$).

TIME-BASE A REQUIREMENTS

3-mm deflection or 125-mV external from DC to 20 MHz increasing to 2-cm deflection or 250-mV external at 100 MHz. Requirements increase below 60 Hz with AC coupling; below 50 kHz with AC low-frequency reject.

TIME BASE B REQUIREMENTS

5-mm deflection or 200 mV external from DC to 20 MHz increasing to 3-cm deflection or 300-mV external at 100 MHz. Requirements increase below 60 Hz with AC coupling.

OTHER

WEIGHTS

Net weight	6½ lb	3.0 kg
Domestic shipping weight	≈10 lb	≈4.5 kg
Export-packed weight	≈14 lb	≈6.4 kg

INCLUDED STANDARD ACCESSORIES

BNC female to BSM female adapter (103-0036-00); two instruction manuals (070-0640-00).

OPTIONAL ACCESSORIES

Optional accessories increase measurement capability and provide added convenience. These and other accessory items are described in detail in the catalog accessory pages.

BNC TO BSM ADAPTER

Converts Type 11B2A front-panel outputs to accept BNC cables.

Order 103-0036-00

Please refer to Terms and Shipment, General Information page.

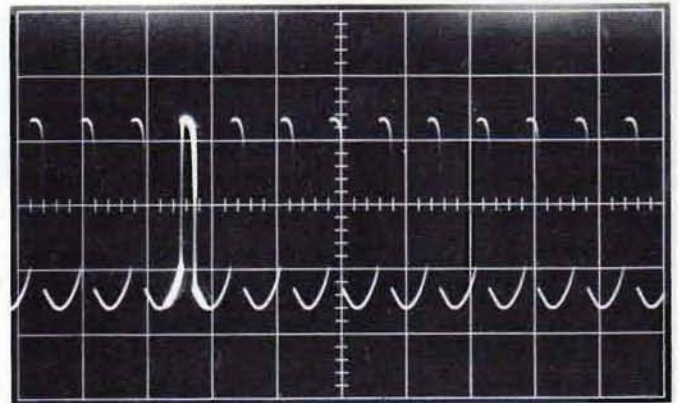

The waveform below (B delayed by A) is a X20 expansion of the intensified portion of the waveform above (A intensified by B). Time Base A at 2 μ s/cm, Time Base B at 0.1 μ s/cm.

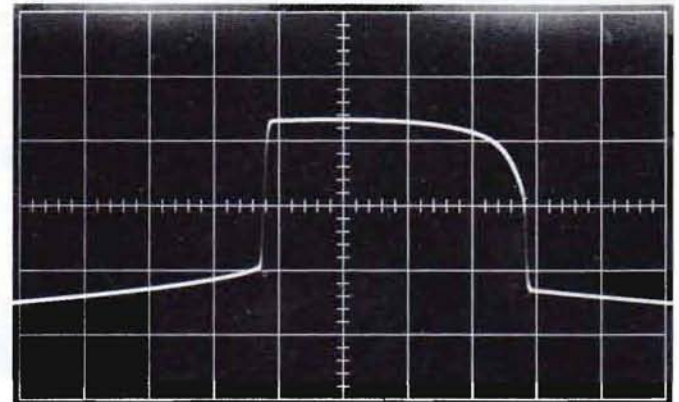

TYPE 661

90-ps RISETIME SAMPLING OSCILLOSCOPE

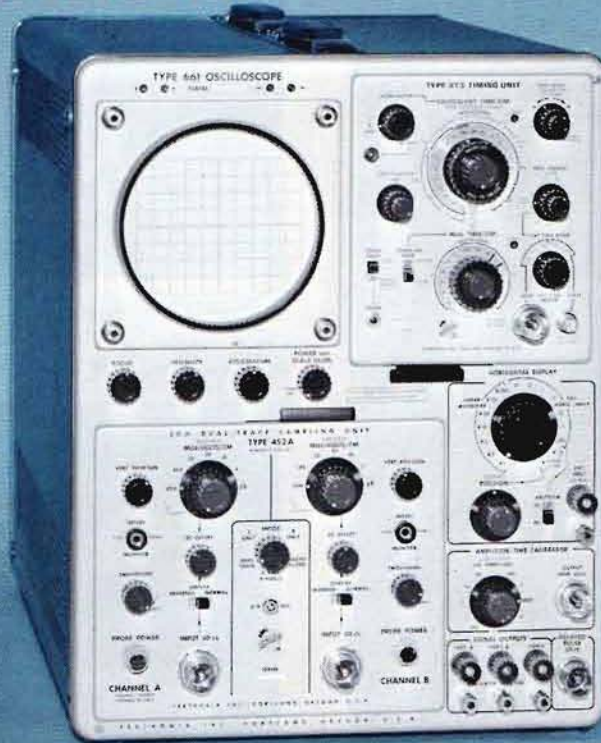

- **THREE VERTICAL PLUG-IN UNITS**
- **10 ps/cm to 5 s/cm CALIBRATED TIME BASE**
- **AMPLITUDE/TIME CALIBRATOR**
- **DELAYED-PULSE OUTPUT**
- **X-Y RECORDER OUTPUTS**

With a Type 5T3 Timing Plug-In Unit and any of three Vertical Plug-In Units, Type 661 comprises an easy-to-operate complete sampling system. Type 5T3 Timing Unit provides a time-base range broad enough to cover most applications, from sub-audio to the picosecond region. In combination with Type 4S1 Sampling Unit, the system is similar (to operate) to a conventional (non-sampling) oscilloscope. Internal triggering eliminates the need for external trigger cabling. With Type 4S2A, the system is capable of displaying signals with extremely fast risetimes. Type 4S3 permits measurement of signals with high source impedances by use of miniature direct sampling probes. All three vertical units feature dual-trace capability, deflection factors to 2 mV/cm, and DC offset control with voltage monitor jack. This combination of deflection factor and DC offset provides 1000-to-1 vertical resolution. X100 time expansion and wide-range time position of Type 5T3 provide 1000-to-1 time resolution.

CHARACTERISTIC SUMMARY

VERTICAL

Three vertical plug-in units are available: Type 4S1 featuring 350-ps risetime, internal triggering and low noise, Type 4S2A with a 90-ps risetime and Type 4S3 with miniature direct-sampling probes and a 350-ps risetime.

HORIZONTAL

(with Type 5T3)

TRIGGERING—To 500 MHz, sync to 5 GHz.

CALIBRATED TIME BASE—10 ps/cm to 5 s/cm.

MAGNIFIER—To X100 for sweep rates from 1 ns/cm to 100 μ s/cm.

CRT

DISPLAY AREA—8 x 10 cm.

ACCELERATING VOLTAGE— \approx 3 kV.

PHOSPHOR—P2.

OTHER

AMPLITUDE/TIME CALIBRATOR—1 mV to 1000 mV, decade steps. 0.01 μ s/cycle to 10 μ s/cycle, decade steps.

POWER REQUIREMENTS—105 V to 125 V or 210 V to 250 V, 50 to 60 Hz, typically 450 W.

CHARACTERISTICS

HORIZONTAL POSITION

Coarse and fine adjustment-shift of display over 10 cm unmagnified or 1000 cm at full magnification.

SWEEP MAGNIFIER

X1, X2, X5, X10, X20, X50, or X100, symmetrical about the screen center, reduces the number of dots/cm and keeps time/dot uniform.

EXTERNAL HORIZONTAL INPUT

Permits externally scanning the sampled display. 50 mV/cm to 5 V/cm deflection factor (into 25-k Ω impedance) is in 7 steps, 1-2-5 sequence, either AC or DC-coupled. Equivalent time per centimeter remains calibrated.

FAST OR SLOW MANUAL SCAN

Permits detailed analysis of any portion of the display. This mode of operation facilitates driving external recorders.

SIGNAL OUTPUTS

Vertical outputs for each channel and a horizontal output is provided. The output amplitude is 200 mV per displayed centimeter through 10 k Ω .

AMPLITUDE/TIME CALIBRATOR

Calibrated amplitude from 1 mV to 1000 mV in 4 decade steps, accurate within 2% at 1000 mV with 50-ohm load. Calibrated time from 0.01 μ s/cycle to 10 μ s/cycle in 4 decade steps, accurate within 0.2%, except within 2% at 0.01 μ s/cycle with 50-ohm load.

DELAYED-PULSE OUTPUT

Serves as step generator for limited TDR measurements or to drive external circuitry. Lead-time in the display is approximately 55 ns with Type 4S1, approximately 10 ns with Type 4S2A and approximately 5 ns with Type 4S3 Sampling Units. Amplitude is approximately 260 mV into 50 Ω (negative-going) and risetime is less than or equal to 130 ps. Output impedance is 50 Ω , reverse terminated.

TEKTRONIX CRT

Flat-faced round tube with an 8-cm by 10-cm viewing area and approx 3-kV accelerating potential. A P2 phosphor is normally supplied.

ILLUMINATED EXTERNAL GRATICULE

Ruled in centimeter squares over an area of 8 by 10 cm, edge lighting is variable with front-panel control. Vertical and horizontal centerlines are further marked in 2-mm divisions for convenience in making time and amplitude measurements.

BEAM-POSITION INDICATORS

Show the direction of the CRT beam when it is deflected away from the center-screen area.

POWER REQUIREMENTS

105 V to 125 V or 210 V to 250 V, 50 to 60 Hz, typically 445 W. Instrument is normally factory wired for 105 V to 125 V, but can be ordered wired for 210 V to 250 V operation.

DIMENSIONS AND WEIGHTS

Height	16 $\frac{7}{8}$ in	42.9 cm
Width	13 $\frac{1}{8}$ in	33.4 cm
Depth	23 $\frac{3}{4}$ in	60.4 cm
Net weight	48 $\frac{1}{4}$ lb	21.9 kg
Domestic shipping weight	\approx 65 lb	\approx 29.5 kg
Export-packed weight	\approx 84 lb	\approx 38.0 kg

INCLUDED STANDARD ACCESSORIES

3-conductor power cord (161-0010-03); 3- to 2-wire adapter (103-0013-00); smoke gray filter (378-0567-00); two instruction manuals (070-0324-00).

OPTIONAL ACCESSORIES

CAMERA

The standard C-12 camera satisfies most trace-recording requirements. For applications that might require a different viewing system, lens, or back, refer to camera descriptions or consult your field engineer, representative, or distributor.

Standard C-12: f/1.9—1:0.85 lens, no-parallax viewing, Polaroid Land* Pack-Film back

Type 661 to C-12 Camera adapter, order 016-0226-00

SCOPE-MOBILE® CART

Model 202-1: storage drawer, 9-position tilt-lock oscilloscope tray

*Registered Trade-Mark, Polaroid Corporation.

Please refer to Terms and Shipment, General Information page.

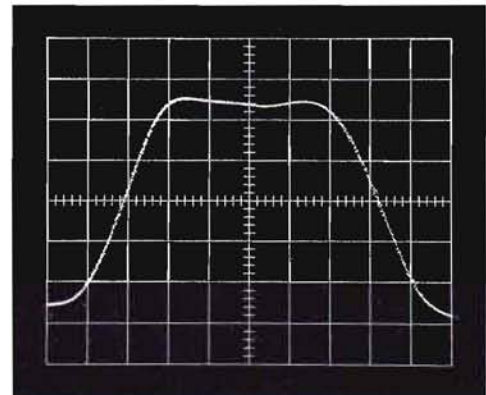

TIME JITTER

A 250 mV, 1.0 ns-wide pulse internally triggering the 4S1/5T3 system. Vertical deflection factor is 50 mV/cm; sweep rate is 0.2 ns/cm. Note that jitter is practically negligible.

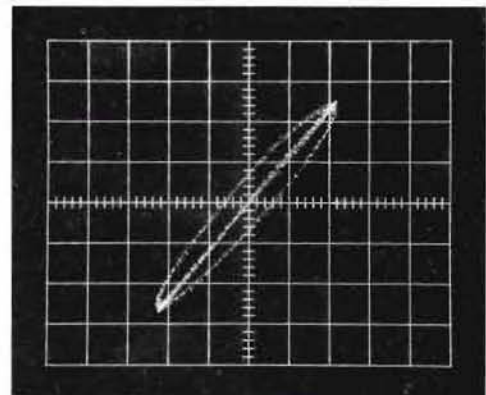

TYPICAL APPLICATION

2 gigahertz sine-wave driving inputs to Type 4S2A for X-Y operation. Diagonal line shows in-phase characteristics. Ellipse is caused by insertion of 8 millimeters of airline to one input, resulting in approximately 20 degrees of phase shift. Resolution below one degree is possible.

TYPE 4S1

350-ps DUAL-TRACE SAMPLING UNIT

- DC-to-1 GHz BANDWIDTH
- INTERNAL DELAY LINES
- ± 1 -VOLT DC OFFSET
- 2 mV/cm to 200 mV/cm DEFLECTION FACTOR
- RANDOM NOISE LESS THAN 1-mV (UNSMOOTHED)

The Type 4S1 Dual-Trace Sampling Unit is a general-purpose sampling plug-in unit for the Type 661 Sampling Oscilloscope. Separate internal trigger takeoffs, delay lines, and terminations are provided, which permit triggering on either A or B input signals.

CHARACTERISTICS

(2 identical channels)

RISETIME

Less than or equal to 350 ps.

BANDWIDTH

Equivalent to DC-to-1 GHz at 3-dB down.

DEFLECTION FACTOR

2 mV/cm to 200 mV/cm in 7 calibrated steps, 1-2-5 sequence. Each step accurate within 3%. Variable between steps, extending to 0.67 mV/cm, uncalibrated.

RANDOM NOISE

Equivalent to an input signal of 1 mV or less, unsmoothed; 0.5 mV, smoothed (tangentially-measured).

INPUT CHARACTERISTICS

Nominally 50 Ω . Safe overload is ± 10 V. GR 874 input connectors.

DC OFFSET RANGE

+1 V to -1 V. Allows signals between +1 V and -1 V limits to be displayed at 2 mV/cm. Signals between +2 V and -2 V limits may be displayed at 200 mV/cm. Monitor jack provides 100X actual DC offset through 100 k Ω .

TRIGGERING

Separate internal delay lines and trigger pickoffs permit triggering on either A or B input signal. Trigger pickoffs deliver to the timing unit approximately $\frac{1}{8}$ of the input signal amplitude.

DISPLAY MODES

A only, B only, Dual-Trace, Algebraic Addition of A and B signals, and X-Y display of A-vertically and B-horizontally (for observation of hysteresis loops, phase shift, and similar displays.) Independent controls for each channel permit positioning and inverting displays as desired. Time coincidence between channels is within 20 ps.



PROBE POWER

Available at front-panel connectors for cathode-follower probes, Type 281 TDR Pulser and Type 282 Adapter for high-impedance probes.

WEIGHTS

Net weight	12 lb	5.4 kg
Domestic shipping weight	≈ 23 lb	≈ 10.4 kg
Export-packed weight	≈ 30 lb	≈ 13.6 kg

INCLUDED STANDARD ACCESSORIES

Two 10X 50- Ω attenuators (017-0078-00); two 5-ns 50- Ω cables (017-0512-00); two instruction manuals (070-0329-00).

OPTIONAL ACCESSORIES

- Type 281 TDR Pulser, order 015-0060-00
- Type 282 Probe Adapter, order 015-0074-00
- P6040/CT-1 Current Probe, order 015-0041-00
- P6034 10X Passive Probe, order 010-0110-00
- P6035 100X Passive Probe, order 010-0111-00
- VP-1 Voltage Pickoff, order 017-0073-00
- Power Divider GR 874-TPD, order 017-0082-00
- Coupling capacitor, GR 874-K, order 017-0028-00

Please refer to Terms and Shipment, General Information page.

TYPE 4S2A

90-ps DUAL-TRACE SAMPLING UNIT

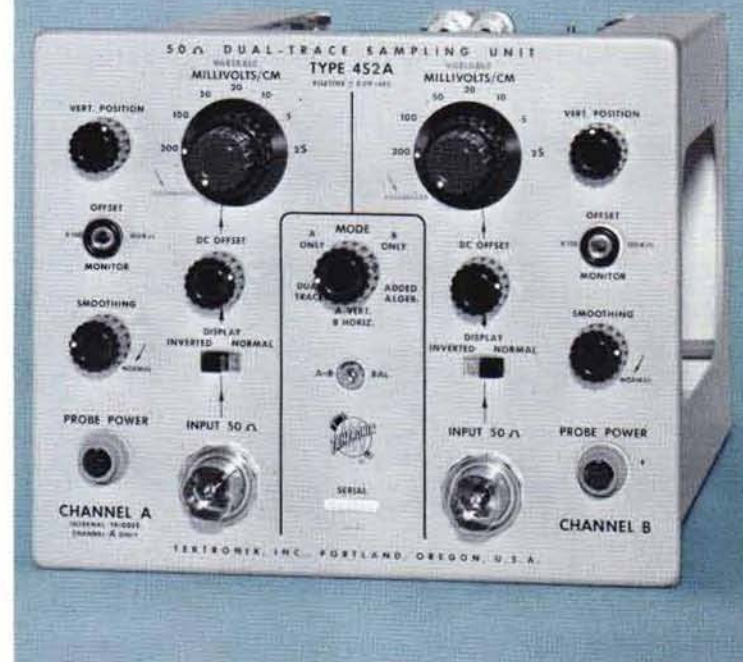

- DC-to-3.9 GHz BANDWIDTH
- ± 1 -VOLT DC OFFSET
- 2 mV/cm to 200 mV/cm DEFLECTION FACTOR
- RANDOM NOISE LESS THAN 4 mV (UNSMOOTHED)

The Type 4S2A Dual-Trace Sampling Unit is a high resolution sampling plug-in unit which, with Types 661 and 5T3, is capable of displaying: 0.1% system discontinuities with centimeter separation (as a reflectometer); the fastest present switching transistor risetimes, including commercially available avalanche types; most tunnel-diode switching times (to 3 mA/pf); and stored charge in switching diodes to the 0.01 picocoulomb/milliampere region. Type 4S2A is also useful for very broad-band lissajous plots, permitting display of fractions of a degree of relative phase shift to over 3 GHz.

CHARACTERISTICS (2 identical channels)

RISETIME

Less than or equal to 90 ps.

BANDWIDTH

Equivalent to DC-to-3.9 GHz at 3-dB down. Useful beyond 5 GHz.

DEFLECTION FACTOR

2 mV/cm to 200 mV/cm in 7 calibrated steps, 1-2-5 sequence. Each step accurate within 3%. Variable between steps, extending to 0.67 mV/cm, uncalibrated.

RANDOM NOISE

Equivalent to an input signal of 4 mV or less, unsmoothed; 2 mV, smoothed (tangentially-measured).

INPUT CHARACTERISTICS

Nominally 50 Ω . Safe overload is ± 5 V. GR 874 input connectors.

DC OFFSET RANGE

+1 V to -1 V. Allows signals between +1 V and -1 V limits to be displayed at 2 mV/cm. Signals between +2 V and -2 V limits may be displayed at 200 mV/cm. Monitor jack provides 100X actual DC offset through 100 k Ω .

TRIGGERING

Internally picked off Channel A only. No internal delay line is provided with either channel. Trigger takeoff delivers to the timing unit approx 1/10 the input signal amplitude.

DISPLAY MODES

A only, B only, Dual-Trace, Algebraic Addition of A and B signals, and X-Y display of A-vertically and B-horizontally (for observation of hysteresis loops, phase shift, and similar displays.) Independent controls for each channel permit positioning and inverting displays as desired. Time coincidence between channels is within 20 ps.

PROBE POWER

Available at front-panel connectors for cathode-follower probes and Type 282 Adapter for high-impedance probes.

WEIGHTS

Net weight	9 $\frac{1}{4}$ lb	4.2 kg
Domestic shipping weight	≈ 17 lb	≈ 7.7 kg
Export-packed weight	≈ 24 lb	≈ 10.9 kg

INCLUDED STANDARD ACCESSORIES

Two 10X 50- Ω attenuators (017-0078-00); two 5-ns 50- Ω cables (017-0502-00); two instruction manuals (070-0536-01).

OPTIONAL ACCESSORIES

- P6034 10X Passive Probe, order 010-0110-00
- P6035 100X Passive Probe, order 010-0111-00
- Power Divider GR874-TPD, order 017-0082-00
- Coupling Capacitor, GR874-K, order 017-0028-00
- Type 113 Delay Line

Please refer to Terms and Shipment, General Information page.

TYPE 4S3

- **MINIATURE DIRECT-SAMPLING PROBES**
- **100 k Ω , 2 pF INPUT RC**
- **DC-to-1 GHz BANDWIDTH**
- **2 mV/cm to 200 mV/cm DEFLECTION FACTOR**
- **RANDOM NOISE LESS THAN 500 μ V (UNSMOOTHED)**

The Type 4S3 Sampling-Probe Unit for Type 661 Sampling Oscilloscope is a special-purpose dual-trace unit with extremely small direct-sampling probes. Sampling is achieved in the probe, permitting signals with high source impedances to be measured at a very low noise level. Type 4S3 retains many of the features of its companion instruments, the Type 4S1 and 4S2A, such as 2 mV/cm deflection factor, monitorable DC Offset, signal inversion, and 5 display modes.

Smoothing controls, in combination with risetime/noise selection, permit correct adjustment of dot transient response for either LOW-NOISE or FAST-RISETIME operations.

CHARACTERISTICS

(2 identical channels)

RISETIME

Less than or equal to 350 ps (FAST RISETIME) or approximately 500 ps (LOW NOISE) with a 50- Ω source.

BANDWIDTH

Equivalent to DC-to-1 GHz at 3-dB down.

DEFLECTION FACTOR

2 mV/cm to 200 mV/cm in 7 calibrated steps, 1-2-5 sequence. Each step accurate within 3%. Variable between steps, extending to 0.67 mV/cm, uncalibrated.

RANDOM NOISE

Equivalent to an input signal of 0.5 mV or less (LOW NOISE), 1 mV or less (FAST RISETIME), unsmoothed with 50- Ω source (tangentially-measured.) A FAST-RISETIME/LOW-NOISE switch allows the operator to trade optimum risetime for optimum noise depending upon particular measurement requirements.

INPUT CHARACTERISTICS

100 k Ω paralleled by 2 pF. Safe overload is ± 10 V.

DC OFFSET RANGE

+1 V to -1 V. Allows signals between +1 V and -1 V limits to be displayed at 2 mV/cm. Signals between +2 V and -2 V limits may be displayed at 200 mV/cm. Monitor jacks provide 100X actual DC offset through 100 k Ω .

350-ps DUAL-TRACE SAMPLING PROBE UNIT



TRIGGERING

External only. Pretrigger required approximately 50 ns prior to signal.

DISPLAY MODES

A only, B only, Dual-Trace, Algebraic Addition of A and B signals, and X-Y displays of A-vertically and B-horizontally (for observation of hysteresis loops, phase shift, and similar displays.) Independent controls for each channel permit positioning and inverting displays as desired. Time coincidence between channels is within 60 ps.

SAMPLING PROBES

Included with the Type 4S3, and extremely compact to permit access to miniaturized circuitry. The sampling bridge is contained in the probe to obtain optimum results. Low-frequency response is approx 3-dB down at 1.5 kHz with the included coupling capacitor; approx 3-dB down at 150 Hz with the coupling capacitor and 10X attenuator.

WEIGHTS

Net weight	9 $\frac{3}{4}$ lb	4.4 kg
Domestic shipping weight	\approx 17 lb	\approx 7.7 kg
Export-packed weight	\approx 24 lb	\approx 10.9 kg

INCLUDED STANDARD ACCESSORIES

Two P6038 probe packages (010-0156-00); VP-2, voltage pick-off, 50 Ω (017-0077-00); two instruction manuals (070-0397-01).

Please refer to Terms and Shipment, General Information page.

TYPE 5T3

SAMPLING TIMING UNIT

- CALIBRATED SWEEP FROM 10 ps/cm to 5 s/cm
- TRIGGERING to 500 MHz, SYNC to 5 GHz
- REAL-TIME or EQUIVALENT-TIME SAMPLING
- WIDE-RANGE MAGNIFIER AND TIME POSITION

The Type 5T3 Timing Unit for Type 661 Oscilloscope incorporates both Equivalent-Time and Real-Time Sampling to provide a very broad range of sweep times. Versatile triggering operation, including 50-ohm and 1-megohm inputs, makes the Type 5T3 readily adaptable to a wide variety of applications.



TIME BASE

Equivalent-time sampling: 10 ps/cm to 100 μ s/cm in 22 calibrated steps, 1-2-5 sequence. Each step accurate within 3%. Variable between steps. Sweep TIME/CM has direct read-out even when magnifier is used. Real-time sampling: 0.2 ms/cm to 5 s/cm in 14 calibrated steps, 1-2-5 sequence. Each step accurate within 3%. Variable between steps extending to approximately 80 μ s/cm.

MAGNIFIER

Sweep TIME/CM from 1 ns/cm to 100 μ s/cm can be magnified up to X100 while maintaining both a constant number of samples/cm and the same Time Position Range. Magnification occurs from a fixed time-reference point at the left edge of the screen.

TIME POSITION RANGE

1 ms, 100 μ s, 10 μ s, 1 μ s, 100 ns and 20 ns, depending on unmagnified EQUIVALENT TIME/CM setting. Coarse and fine TIME POSITION controls position start of the display through a time interval equal to the TIME POSITION RANGE setting.

SAMPLES/DIV

Continuously variable adjustment of samples displayed per centimeter horizontally from approximately 5 samples/cm to an immeasurable number of samples/cm. Allows optimum adjustment of display rate and dot density. Timed slow scan (approximately 5 s/cm to 0.5 sec/cm) for use with Y-T recorder.

SWEEP MODES

Normal (repetitive) or Single Display. Front panel START button for single-display operation.

TRIGGER

NORMAL MODE

Triggering from DC to several hundred megahertz at 5-mV sensitivity. Schmitt-type tunnel-diode logic, operation similar to conventional (real-time) oscilloscope. Stability and Trigger Level controls; free-running displays possible.

AUTOMATIC RECOVERY MODE

Triggering on fast, short pulses or synchronizing on high-frequency signals up to 500-MHz repetition at 5-mV sensitivity. One-knob adjustment for a wide variety of trigger signals.

UHF SYNC MODE

Stable synchronization on low-amplitude signals from 500 MHz to 5 GHz. 50-ohm input connected directly (by-passing transistor amplifiers) through high-pass filter to very fast tunnel-diode multivibrator.

TYPE 5T3

VIEW THESE 2 SIGNALS WITH THE TYPE 661/5T3/4S2A

50-Hz REAL-TIME DISPLAY

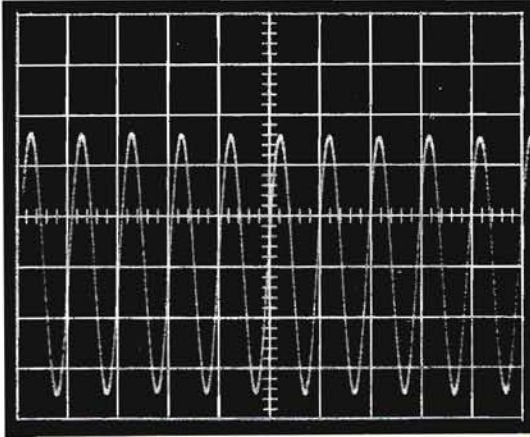

Horiz: 20 ms/cm; Vert: 100 mV/cm
External trigger, 1-megohm input

5-GHz EQUIVALENT-TIME DISPLAY

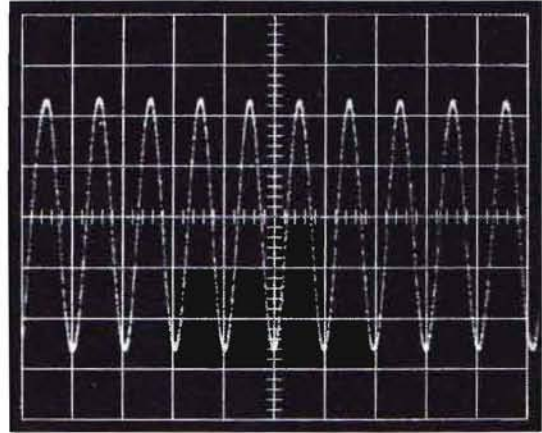

Horiz: 0.2 ns/cm; Vert: 100 mV/cm
External trigger, UHF Sync Mode

PULSE TRIGGERING

SOURCE	REPETITION RATE	AMPLITUDE*
EXTERNAL 1-M Ω input	DC to 20 MHz	50 mV to 1.5 V (100 V max DC)
EXTERNAL 50- Ω input	DC to 500 MHz	5 mV to 150 mV (5 V max DC)
	500 MHz to 5 GHz (UHF Sync)	

*Either polarity.

SINEWAVE TRIGGERING

SOURCE	FREQUENCY	COUPLING	AMPLITUDE
EXTERNAL 1-M Ω input	DC to 20 MHz	DC	100 mV to 3 V peak-to-peak
	160 Hz to 20 MHz	AC	
EXTERNAL 50- Ω input	DC to 500 MHz	DC	10 mV to 300 mV peak-to-peak
	500 kHz to 500 MHz	AC	
	500 MHz to 5 GHz	UHF Sync	

SOURCES

Internal, if Sampling Unit contains trigger takeoff. External (AC or DC coupling). A 1-M Ω input for high-impedance probes and a 50- Ω input for high-frequency signals. Calibrator provides approximately 100 mV signal from Amplitude/Time Calibrator on Type 661.

JITTER

Depends on signal shape, repetition rate and amplitude; ≤ 30 ps under optimum conditions.

WEIGHTS

Net weight	6 $\frac{3}{4}$ lb	3.1 kg
Domestic shipping weight	≈ 10 lb	≈ 4.5 kg
Export-packed weight	≈ 16 lb	≈ 7.3 kg

INCLUDED STANDARD ACCESSORIES

10X 50- Ω attenuator (017-0078-00); 5-ns 50- Ω cable (017-0512-00); patch cord, BNC-to-banana plug (012-0090-00); two instruction manuals (070-0470-00).

Please refer to Terms and Shipment, General Information page.

SQUAREWAVE GENERATOR



- **1-ns RISE TIME**
- **10 Hz to 1 MHz REPETITION RATE**
- **HI-AMPLITUDE OR FAST-RISE OUTPUTS**
- **SYNC INPUT, TRIGGER OUTPUT**

This general-purpose generator provides simultaneous positive and negative-going output transitions with ≤ 1 -ns risetime into 50Ω , or positive-going hi-amplitude output with ≤ 12 -ns risetime into 50Ω . A clean transition and flat top make the Type 106 ideal for checking oscilloscope transient response. It can be used in such applications as diode recovery, core testing, digital and analog design.

OUTPUT CHARACTERISTICS		
CHARACTERISTIC	+ and - FAST-RISE OUTPUTS	HI-AMPLITUDE OUTPUT
RISETIME (into 50Ω)	≤ 1 ns at 0.5 V	≤ 12 ns at 12 V, ≤ 20 ns at 0.5 V ≤ 120 ns with no external load
REPETITION RATE	10 Hz to 1 MHz; decade steps, accuracy $\pm 10\%$, variable between steps uncalibrated	
SYMMETRY	Duty cycle variable from $\leq 45\%$ to $\geq 55\%$	
AMPLITUDE (into 50Ω)	≤ 50 mV to ≥ 500 mV	≤ 0.5 V to ≥ 12 V, (≥ 7 V to ≤ 120 V unterminated)
ABERRATIONS (into 50Ω)	$\leq +$ and $- 2\%$ or $+ and - 6$ mV (whichever is greater) in first 5 ns*, typically $\leq 0.5\%$ for remainder of pulse top	$\leq +$ and $- 2\%$ in first 100 ns*, typically $\leq 0.5\%$ for remainder of pulse top

*Time period begins at 98%-amplitude point on rising edge.

OTHER CHARACTERISTICS

SYNC INPUT

Accepts sinewaves, squarewaves, or pulses. Accepts 5 V to 100 V peak to peak sinewave, 2.5 V to 50 V pulse or squarewave, 100 Hz to 1 MHz.

TRIGGER OUTPUT

Positive and negative going triggers occur within 50 ns of the rise and fall of the HI-AMPLITUDE squarewave. Positive triggers occur within 50 ns of leading edge of fast-rise outputs. Risetime is 50 ns and amplitude is 0.1 V or more into 50Ω . Time jitter is less than 300 ps.

POWER REQUIREMENTS

103.5 V to 126.5 V or 207 V to 253 V, 50 to 60 Hz. Low or high range selected by rear-panel switch. Approx 85 watts maximum power consumption at 115 VAC.

DIMENSIONS AND WEIGHTS

Height	6 $\frac{3}{4}$ in	17.1 cm
Width	9 in	22.8 cm
Depth	15 $\frac{3}{4}$ in	40 cm
Net weight	15 lb	6.8 kg
Domestic shipping weight	≈ 21 lb	≈ 9.6 kg
Export-packed weight	≈ 29 lb	≈ 13.2 kg

INCLUDED STANDARD ACCESSORIES

5-ns cable (017-0502-00); 50- Ω GR-to-BNC in-line termination (017-0083-00); right-angle 3-conductor power cord (161-0024-01); 3 to 2-wire adapter (103-0013-00); two instruction manuals (070-0523-00). (Power cord for MOD 146B is 161-0031-00).

TYPE 106 SQUARE-WAVE GENERATOR MOD 146B

As above, but less cabinet, for mounting in Rack Adapter.

RACK ADAPTER FOR TYPE 106, 114, 184, 191 and 284

Converts these generators for rack mounting. Any combination of two of these instruments can be mounted side by side in a 19-in rack, in only 5 $\frac{1}{4}$ inches of panel height. Up to four Type 284's can be mounted side-by-side, or two Type 284's can be mounted with one of the other generators. Adapter provides forced-air ventilation and shielding between compartments. Blank panels to cover unused opening are available when only one generator is installed. Special power cord (161-0031-00) is required for each instrument installed.

RACK ADAPTER (016-0086-01)

$\frac{1}{2}$ -WIDTH BLANK PANEL (016-0081-00)

$\frac{1}{4}$ -WIDTH BLANK PANEL (016-0109-00)

SPECIAL POWER CORD (161-0031-00)

Please refer to Terms and Shipment, General Information page.

TYPE 109

PULSE GENERATOR

- 250-ps RISETIME PULSES
- ALTERNATE PULSES OF EQUAL OR DIFFERENT TIME DURATION
- 0-55 V CALIBRATED VARIABLE AMPLITUDE
- SELECTABLE POLARITY

The Type 109 is intended for use with fast-rise sampling or conventional oscilloscopes that generate their own internal sweep trigger. The Type 109 is transistorized and requires no warmup time before operating.

PULSE CHARACTERISTICS	
CHARACTERISTICS	PERFORMANCE
RISETIME	Less than 250 ps
AMPLITUDE	Adjustable from 0 through 55 V, accuracy $\pm 3\%$
REPETITION RATE	Preset between 550 p/s and 720 p/s (using two charge lines)
PULSE DURATION	0.5 ns to max of 100 ns at full rep rate; 300 ns at half rep rate
DECAY	approx 10% in 300 ns
POLARITY	Positive or negative
OUTPUT IMPEDANCE	50 Ω

CHARGE LINES

Either one or two charge lines can be used to provide alternate equal or unequal pulses as desired. Equal charge lines produce a repetition rate of 550 pulses per second to 720 pulses per second.

EXTERNAL DC CHARGE VOLTAGE INPUTS

Use of external charge voltages allows alternate pulses to be of different amplitude and polarity. Maximum external charge voltage is 600 volts. With up to 100 volts input, the output amplitude will be half the external input amplitude. At voltage inputs over 100 volts, the output amplitude will be less than half the input amplitude. At pulse outputs over 50 volts, irregularities may occur.

POWER REQUIREMENT

Wired for 105 to 125 V, may be ordered with the taps connected for 210 to 250 V. 50 to 800 Hz, 60 watts maximum.

DIMENSIONS AND WEIGHTS

Height	7 $\frac{3}{4}$ in	19.7 cm
Width	4 $\frac{7}{8}$ in	12.2 cm
Length	11 $\frac{7}{8}$ in	30.2 cm
Net weight	8 $\frac{1}{4}$ lb	3.8 kg
Domestic shipping weight	≈ 17 lb	≈ 7.7 kg
Export-packed weight	≈ 28 lb	≈ 12.7 kg



INCLUDED STANDARD ACCESSORIES

Charge network (017-0067-00); three 5-ns cables (017-0502-00); 3-conductor power cord (161-0010-03); 3 to 2-wire adapter (103-0013-00); two instruction manuals (070-0299-00).

Please refer to Terms and Shipment, General Information page.

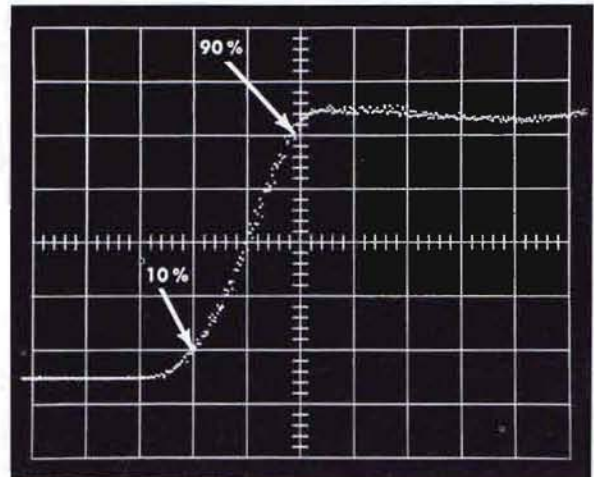

Waveform showing the Type 109 pulse displayed on a Tektronix Type 661 [Sampling] Oscilloscope with an equivalent sweep rate of 0.2 ns/cm. Combined risetime of the system, between 10% and 90% amplitude levels, is less than 0.4 nano-second.

PRETRIGGER PULSE GENERATOR



- **0.5-ns RISETIME PULSES**
- **PULSE DURATIONS TO 1.5 μ s**
- **10 Hz to 100 kHz REPETITION RATE**
- **SELECTABLE POLARITY**
- **30 to 250-ns PRETRIGGERING**

The Type 111 is a low cost, fast-rise pulse generator. The unit provides two pulse outputs: fast-rising output pulses and pretrigger pulses. The pretrigger pulses occur from 30 to 250 nanoseconds ahead of each output pulse. Pretrigger pulses can be used as a regenerated trigger signal for sampling systems without internal delay lines or as a triggering signal for a conventional oscilloscope. The amount of delay between the pretrigger pulse and the output pulse can be varied by means of a front-panel control. This eliminates the need for delay cables.

OUTPUT PULSE CHARACTERISTICS

CHARACTERISTIC	PERFORMANCE (into 50 Ω)
RISETIME	≤ 0.5 ns (either polarity)
REPETITION RATE	Continuously variable, 10 Hz to 100 kHz
PULSE DURATION	2 ns to 1.5 μ s with appropriate charge line
AMPLITUDE	≥ 10 V
POLARITY	Positive or negative
OUTPUT IMPEDANCE	50 Ω
ABERRATIONS	$\leq 5\%$ P to P on leading edge and top of output pulse; $\leq 10\%$ P to P on region following the pulse

PRETRIGGER PULSE CHARACTERISTICS

Amplitude: ≈ 10 V, duration: ≈ 300 ns, risetime: ≤ 7 ns.

PULSE DELAY

30 to 250 ns, continuously variable. Time jitter less than 100 ps.

OUTPUT IMPEDANCE

50 ohms.

EXTERNAL TRIGGER SIGNAL

+3 V or greater at a rate of rise of 3 V/ μ s or faster. As long as rate of rise is maintained, repetition rates from 0 to 100 kHz can be used.

POWER REQUIREMENTS

Wired for 105 to 125 V, may be ordered with taps connected for 210 to 250 V. 50 to 800 Hz, approx 35 watts.

DIMENSIONS AND WEIGHTS

Height	11 $\frac{7}{16}$ in	29 cm
Width	6 $\frac{15}{16}$ in	17.7 cm
Depth	11 $\frac{5}{16}$ in	28.7 cm
Net weight	9 lb	4.1 kg
Domestic shipping weight	≈ 14 lb	≈ 6.4 kg
Export-packed weight	≈ 20 lb	≈ 9.1 kg

INCLUDED STANDARD ACCESSORIES

5-ns 50- Ω cable (017-0502-00); 9-ns 50- Ω charge line (017-0506-00); 50- Ω 10X attenuator (017-0078-00); 3-conductor power cord (161-0010-03); 3 to 2-wire adapter (103-0013-00); two instruction manuals (070-0252-00).

Please refer to Terms and Shipment, General Information page.

TYPE 113

DELAY CABLE

Transmission Lines

Transmission lines used for nanosecond pulses are commonly of the transverse electric and magnetic fields mode type. The Type 113 uses this mode, because response is desired to zero frequency with minimum dispersion. In the nanosecond region, skin effect losses cause most of the pulse distortion in well-constructed cables. This results in a nongaussian response. Risetimes of cascaded cables do not follow the usual RMS addition method of combining risetimes, as in gaussian amplifiers.

Transmission line distortion of a step function shows up in a distinctive way. After a small transition period, the output rises fairly rapidly and then slows considerably, compared to an RC charge. An RC step requires 2.2 time constants to change from 10% to 90% of the input step. A transmission line requires 30 times the 0-to-50% risetime period to accomplish this (10% to 90%) transition.

The graph illustrates time of rise from 0-to-50% (T_0) of the input for various common coaxial cables. Note that the risetime deteriorates as the square of the length. Thus, it is very important to keep cable lengths (or delays) to a minimum. The Type 113 uses about 50 feet of $\frac{7}{8}$ in diameter cable, resulting in a 0-to-50% risetime of about 0.0025 nanosecond, and 10% to 90% of better than 0.1 nanosecond.

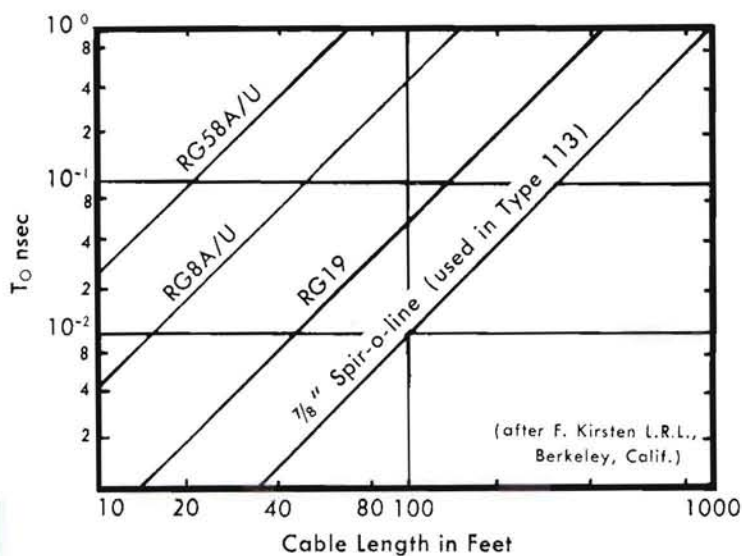

The Tektronix Type 113 Delay Cable has a delay of 60 ns and a characteristic impedance of 50Ω . In general it is used in those sampling applications where the vertical amplifier does not contain internal delay lines and the triggering of the sweep is external and signal delay is required.

CHARACTERISTIC IMPEDANCE

$50 \Omega \pm 1\%$.

HIGH QUALITY CABLE

Approximately 1.5-dB loss per 100 feet at 1000 MHz. Rise-time approximately 0.1 ns.

DIMENSIONS AND WEIGHTS

Height	$22\frac{3}{8}$ in	57.1 cm
Width	$8\frac{5}{8}$ in	21.9 cm
Depth	$21\frac{7}{8}$ in	55.5 cm
Net weight	$44\frac{3}{4}$ lb	20.3 kg
Domestic shipping weight	≈ 60 lb	≈ 27.3 kg
Export-packed weight	≈ 75 lb	≈ 34.1 kg

Please refer to Terms and Shipment, General Information page.

PULSE GENERATOR

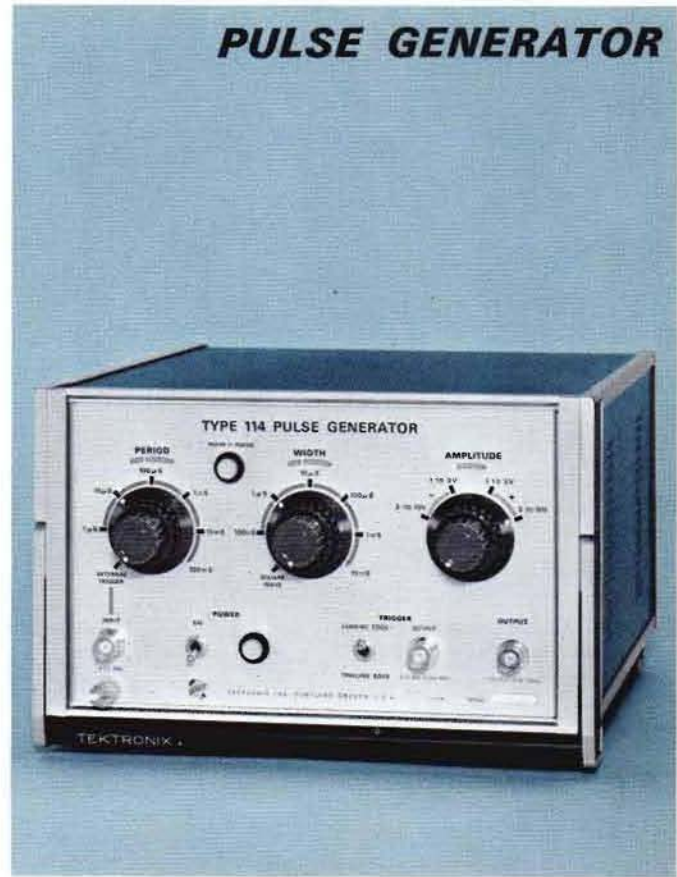

- PULSES OR SYMMETRICAL SQUAREWAVES
- 10-ns RISETIME AND FALLTIME
- VARIABLE PULSE PERIOD, WIDTH AND AMPLITUDE
- ± 10 V INTO 50 OHMS
- SHORT-PROOF OUTPUT

The Type 114 is a general-purpose pulse and squarewave generator designed for laboratory and production test facilities. The broad operating range of the Type 114 makes it well suited for applications such as studying network response to changes in pulse period and/or width, or determining the step response of systems.

OUTPUT CHARACTERISTICS

CHARACTERISTIC	PERFORMANCE	ACCURACY
RISE AND FALL TIME	≤ 10 ns	—
PULSE OR SQUAREWAVE PERIODS	5 ranges from 1 μ s to 10 ms continuously variable from 1 μ s to 100 ms.	Pulse: $\pm 3\%$ with variable in calibrated position. Square-wave: $\pm 5\%$ from 100 ms to 10 μ s, $\pm 10\%$ at 1 μ s with variable in calibrated position
PULSE WIDTH (DURATION)	5 ranges from 100 ns to 1 ms continuously variable from 100 ns to 10 ms	$\pm 3\%*$ from 1 μ s to 1 ms, $\pm 5%*$ at 100 ns; variable control in calibrated position
AMPLITUDE	1 V to 3 V and 3 V to 10 V, positive or negative polarity. Variable within each range. Maximum: 10 V into 50 Ω , 16 V into 1 k Ω	—
POLARITY	Positive or negative	—
ABERRATIONS	$\leq 5\%$ (at maximum amplitude)	—

OTHER CHARACTERISTICS

EXTERNAL TRIGGER INPUT REQUIREMENT

Trigger signals from +2 V to +20 V having a risetime of 1 μ s or less. Signals up to 2 MHz may be used.

TRIGGER OUTPUT

≥ 2 V, open circuit; approx 0.5 V into 50- Ω load. Front-panel switch sets trigger output pulse to occur at leading or trailing edge of output pulse.

POWER REQUIREMENTS

94.5 V to 137.5 V or 189 V to 275 V, 50 to 400 Hz. Low or high range selected by rear-panel switch. Approx 15 watts maximum power consumption.

*Plus 10 ns on negative pulse.

DIMENSIONS AND WEIGHTS

Height	6 $\frac{3}{4}$ in	17.1 cm
Width	9 in	22.8 cm
Depth	12 $\frac{7}{8}$ in	33.6 cm
Net Weight	9 $\frac{1}{4}$ lb	4.2 kg
Domestic shipping weight	≈ 13 lb	≈ 5.9 kg
Export-packed weight	≈ 23 lb	≈ 10.5 kg

INCLUDED STANDARD ACCESSORIES

Right-angle 3-conductor power cord (161-0024-01); 3 to 2-wire adapter (103-0013-00); two instruction manuals (070-0465-00). (Power Cord for MOD 146B is 161-0031-00).

TYPE 114 PULSE GENERATOR MOD 146B

As above, but less cabinet, for mounting in rack adapter.

RACK ADAPTER FOR TYPE 106, 114, 184, 191 and 284

Allows mounting any combination of two of these instruments, side by side in a 19-inch rack, in only 5 $\frac{1}{4}$ inches of panel height. Up to four Type 284's can be mounted side-by-side, or two Type 284's can be mounted with one of the other generators. Adapter provides forced-air ventilation and shielding between compartments. Blank panels are available to cover unused opening when only one generator is installed. Special power cord (161-0031-00) is required for each instrument installed. Blank panels and special power cords are not supplied with the rack adapter.

RACK ADAPTER, order 016-0086-01

$\frac{1}{2}$ -WIDTH BLANK PANEL, order 016-0081-00

$\frac{1}{4}$ -WIDTH BLANK PANEL, order 016-0109-00

SPECIAL POWER CORD, order 161-0031-00

Please refer to Terms and Shipment, General Information Page.

TYPE R116

PROGRAMMABLE PULSE GENERATOR

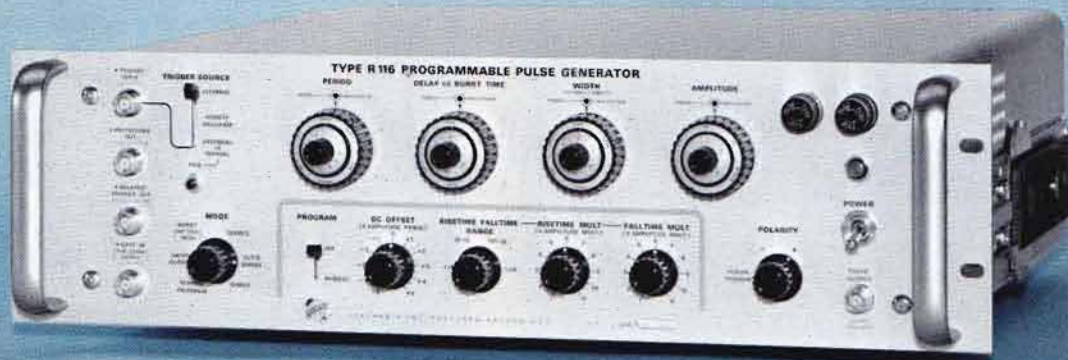

CALIBRATED AND PROGRAMMABLE PARAMETERS

- **MODE**
- **TRIGGER SOURCE**
- **PERIOD**
- **DELAY OR BURST TIME**
- **WIDTH**
- **POLARITY**
- **AMPLITUDE**
- **DC OFFSET**
- **RISETIME AND FALLTIME**

The Type R116 is a broad-range, programmable pulse generator intended primarily for applications where various combinations of pulse amplitude, width, polarity, and other features are required in rapid sequence.

All functions and parameters are easily programmable with no need for extra-cost modifications. The Type R116 can also be operated manually from calibrated front-panel controls for initial test setup and for applications not requiring external programming. Full programming capability requires 21 bits and 7 analog lines.

PULSE CHARACTERISTICS (at 10-volts amplitude)

CHARACTERISTICS	RANGE	BASIC ACCURACY (% of dial)	REQUIRED PER PROGRAM
*RISETIME AND FALLTIME	10 ns to 110 μ s	$\pm 5\%$ (except $\pm 10\%$ on 1 and 10 ns range. <10 ns uncalibrated.)	3 bits + 2 resistors
*PERIOD	100 ns to 11 ms	$\pm 3\%$, except shortest period range is $\pm 5\%$	4 bits + 1 resistor
*WIDTH	50 ns to 550 μ s	$\pm 3\%$, except shortest width is $\pm 5\%$.	3 bits + 1 resistor
*DELAY OR BURST TIME	50 ns to 550 μ s	$\pm 3\%$ +10 ns	3 bits + 1 resistor
*AMPLITUDE (into 50 Ω)	0.4 V to 10 V	$\pm 3\%$ all ranges	2 bits + 1 resistor
*DC OFFSET (continuous)	-5 V to +5 V	$\pm 5\%$ ± 100 mV	1 resistor
POLARITY	positive or negative		1 bit

*These parameters are calibrated and continuously variable.

PROGRAM ACCURACY

Accuracy of the remote program when using recommended program resistor values is the same as the corresponding front-panel control plus 2%, plus any error in the value of the program resistor. For example, the period which has a basic accuracy of $\pm 3\%$ from the front panel would have a maximum error of $\pm 5\%$, plus the error in the programming resistor when it is remotely programmed. Accuracy of remote programming may be improved by calibrating the instrument for remote programming rather than for front-panel operation.

OPERATING MODES

SINGLE

Undelayed pulses.

DELAYED SINGLE

Pulses occurring at the end of the delay time.

DOUBLE

Pairs of pulses: one occurring at the time of the normal undelayed pulse, one occurring at the end of the delay time. 50-ns minimum pulse separation.

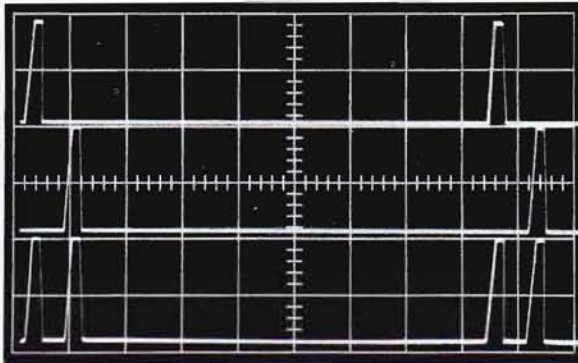

Multiple exposure showing timing relationships between Single, Delayed Single, and Double operating modes. Oscilloscope triggered from Type R116 Pretrigger. 50 $\mu\text{s}/\text{cm}$ sweep time, 5V/cm deflection factor.

BURST

Output pulses obtained for the duration of Burst Time when initiated by external triggering pulse. Pulses occur at internal repetition rate.

GATED OUTPUT

Output pulses obtained for the duration of input gate. Pulses are synchronous with input gate and occur at internal repetition rate.

REMOTE PROGRAM

Permits remote programming of the operating mode. Programming requires 4 bits.

INPUTS

+ TRIGGER

Accepts trigger from +2V to +20V, for triggering signals having at least 100 ns separation; +2V to +4V for signals having at least 50 ns separation. DC-coupled input.

+ GATE

Accepts gate from +2V to +10V. Output pulses start approximately 100 ns after gate reaches +2-V level and continue until gate drops below +2V. Output pulses synchronous with gate. DC-coupled input.

AUXILIARY OUTPUTS

+ PRETRIGGER

2V minimum into 1 k Ω , risetime less than 20 ns. Occurs approx 30 ns prior to start of the undelayed output pulse.

+ DELAYED TRIGGER

2V minimum into 1 k Ω , risetime less than 20 ns. Occurs approx 30 ns prior to the start of the delayed output pulse.

OTHER CHARACTERISTICS

POWER REQUIREMENTS

94.5 to 137.5V or 189 to 275V, selectable by rear-panel switch. 50 to 60 Hz, 100 watts maximum.

DIMENSIONS AND WEIGHTS

Height	5 $\frac{1}{4}$ in	13.3 cm
Width	19 in	48.3 cm
Depth	17 $\frac{1}{2}$ in	44.5 cm
Net weight	25 $\frac{3}{4}$ lb	11.7 kg
Domestic shipping weight	≈ 61 lb	≈ 27.7 kg
Export-packed weight	≈ 86 lb	≈ 39.1 kg

INCLUDED STANDARD ACCESSORIES

30-in 50- Ω BNC cable (012-0057-01); 50- Ω BNC termination (011-0049-00); 36-pin remote program connector (131-0293-00); set mounting tracks (351-0084-00); set mounting hardware, cabinet feet kit (016-0052-00); 3-conductor power cord (161-0024-01); 3 to 2-wire adapter (103-0013-00); two instruction manuals (070-0498-00).

OPTIONAL ACCESSORIES

Optional accessories increase measurement capability and provide added convenience. See catalog accessory pages for additional information.

CIRCUIT BOARD EXTENSION

Permits mounting of circuit boards away from surrounding circuitry for convenient servicing.
Order 012-0078-00

Please refer to Terms and Shipment, General Information Page.

TYPE 122 FM122 RM122

LOW-LEVEL PREAMPLIFIER

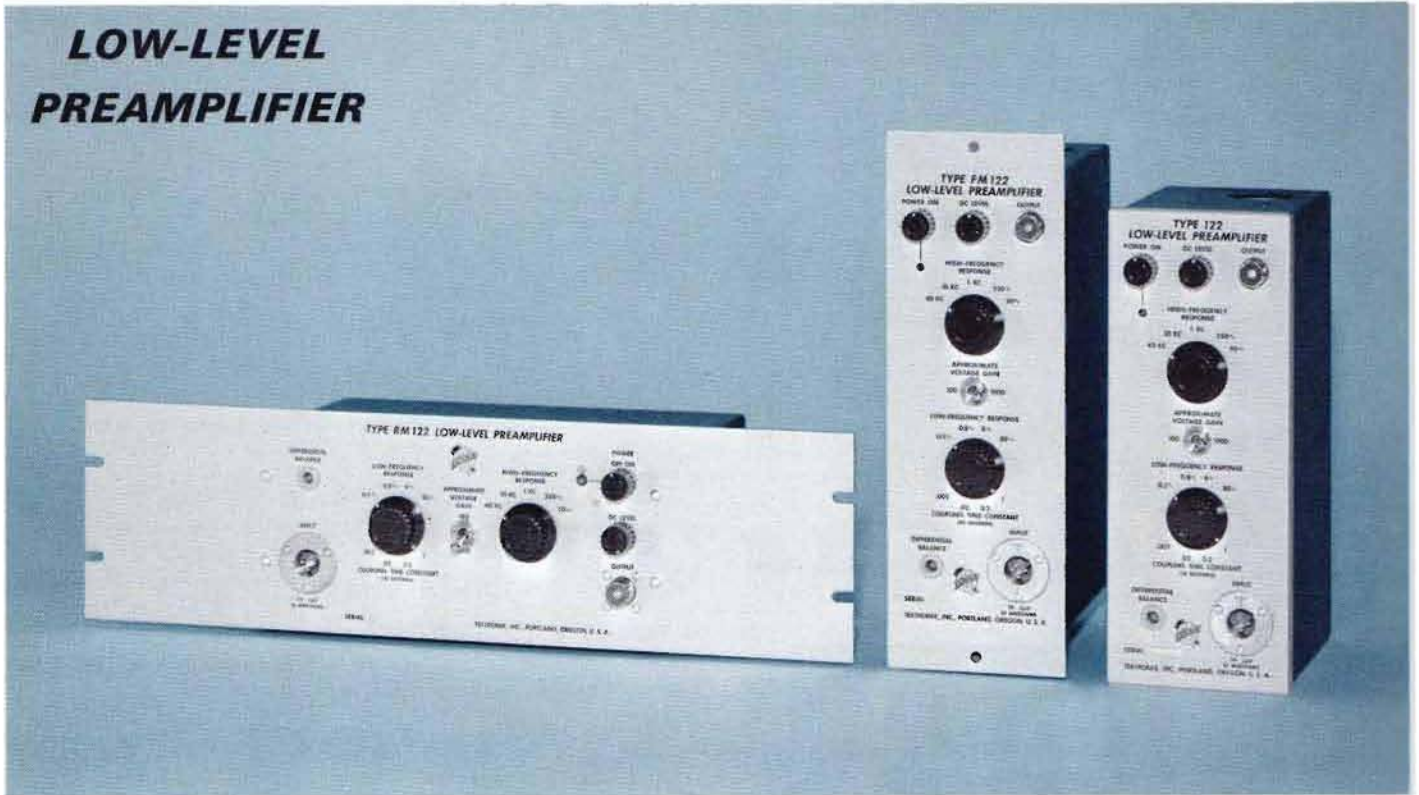

- **APPROXIMATE VOLTAGE GAIN: 100 OR 1000**
- **SINGLE ENDED OR DIFFERENTIAL INPUT**

The Tektronix Type 122, FM122, or RM122 Low-Level Preamplifier is a compact 3-stage amplifier extending the usefulness of the oscilloscope into the microvolt region. The Type 122 is especially useful in biological research and other applications that require the amplification of microvolt signals.

BANDWIDTH

0.2 Hz to 40 kHz. High and low-frequency —3 dB points can be set by front panel switches.

APPROXIMATE VOLTAGE GAIN

100 or 1000, selected by a toggle switch.

INPUT RC

10 megohms paralleled by approximately 50 pF.

COMMON-MODE REJECTION RATIO (CMRR)

Better than 10,000:1 between 5 Hz and 40 kHz. Maximum common-mode input signal: 4 V.

SIGNAL OUTPUT

20 V (peak to peak) maximum in high gain position, 10 V (peak to peak) maximum in low gain position; AC signals up to 0.02 V (gain 1000) or 0.1 V (gain 100) and DC levels up to ± 0.1 V [either gain setting] can be applied before waveform distortion occurs. Output impedance is approximately 1000 ohms.

NOISE LEVEL

1 to 5- μ V RMS referred to input with input grounded.

POWER REQUIREMENTS

+135 V at 5 mA, -90 V at 4 mA, and 6.3 V at 0.9 A, applied through a standard octal plug. The Type 122 can be powered by the Type 125 Power Supply or by batteries.

INCLUDED STANDARD ACCESSORIES

Output cable (012-0003-00); input plug (131-0013-00); two instruction manuals (070-0246-00). Type FM122 and RM122 include mounting hardware.

DIMENSIONS AND WEIGHTS—TYPE 122

Height	12 $\frac{1}{4}$ in	31.2 cm
Width	4 $\frac{1}{8}$ in	10.5 cm
Depth	7 $\frac{1}{8}$ in	18.1 cm
Net weight	4 $\frac{1}{4}$ lb	1.9 kg
Domestic shipping weight	\approx 9 lb	\approx 4.1 kg
Export-packed weight	\approx 13 lb	\approx 5.9 kg

DIMENSIONS AND WEIGHTS—TYPE FM122

Electrically identical to Type 122, but designed to mount vertically in a standard rack with associated instruments. Can be mounted directly or mounted by Tektronix mounting frame. (see Type 125 catalog page for mounting frame information).

Height	14 $\frac{5}{8}$ in	37.2 cm
Width	4 $\frac{1}{8}$ in	10.5 cm
Depth	7 in	17.8 cm
Net weight	4 $\frac{3}{4}$ lb	2.2 kg
Domestic shipping weight	\approx 9 lb	\approx 4.1 kg
Export-packed weight	\approx 13 lb	\approx 5.9 kg

DIMENSIONS AND WEIGHTS—TYPE RM122

Electrically identical to Type 122, but designed for horizontal mounting in standard 19-in rack.

Height	5 $\frac{1}{4}$ in	13.4 cm
Width	19 in	48.3 cm
Depth	7 in	17.8 cm
Net weight	4 $\frac{3}{4}$ lb	2.2 kg
Domestic shipping weight	\approx 11 lb	\approx 5.0 kg
Export-packed weight	\approx 18 lb	\approx 8.2 kg

Please refer to Terms and Shipment, General Information page.

POWER SUPPLY



- **POWERS UP TO FOUR TYPE 122 AMPLIFIERS**
- **ELECTRONIC VOLTAGE REGULATION**

POWER OUTPUT

Supply voltages with corresponding ripple: +135 V, <3 mV; -90 V, <2 mV; -6 V, <5 mV. Voltage stability assured by regulated heater supply.

POWER REQUIREMENTS

110 watts, 50 to 60 Hz. Instrument factory wired for 105 V to 125 V (117 V nominal) operation. Transformer taps permit operation at 210 V to 250 V (234 V nominal). Can be ordered factory wired for 210 V to 250 V operation.

INCLUDED STANDARD ACCESSORIES

Four 36-inch interconnecting cables (012-0065-00); 3-conductor power cord (161-0010-03); 3 to 2-wire adapter (103-0013-00); two instruction manuals (070-0246-00). In addition, Types FM125 and RM125 include mounting hardware.

DIMENSIONS AND WEIGHTS—TYPE 125

Height	12 ¹ / ₄ in	31.2 cm
Width	4 ¹ / ₈ in	10.5 cm
Depth	10 ³ / ₈ in	26.4 cm
Net weight	14 ³ / ₄ lb	6.7 kg
Domestic shipping weight	≈21 lb	≈ 9.6 kg
Export-packed weight	≈40 lb	≈18.2 kg

DIMENSIONS AND WEIGHTS—TYPE FM125

Electrically identical to Type 125, but designed to mount vertically in a standard rack with associated instruments. Can be mounted directly or mounted by Tektronix mounting frame.

Height	14 ⁵ / ₈ in	37.2 cm
Width	4 ¹ / ₈ in	10.5 cm
Depth	13 ¹ / ₂ in	34.3 cm
Net weight	14 ¹ / ₂ lb	6.6 kg
Domestic shipping weight	≈21 lb	≈ 9.6 kg
Export-packed weight	≈40 lb	≈18.2 kg

DIMENSIONS AND WEIGHTS—TYPE RM125

Electrically identical to Type 125, but designed for horizontal mounting in a standard 19-in rack.

Height	5 ¹ / ₄ in	13.3 cm
Width	19 in	48.3 cm
Rack depth	13 ¹ / ₂ in	34.3 cm
Net weight	16 ¹ / ₂ lb	7.5 kg
Domestic shipping weight	≈28 lb	≈12.7 kg
Export-packed weight	≈40 lb	≈18.2 kg

OPTIONAL ACCESSORIES

MOUNTING FRAME FOR TYPE FM125

Fits any standard 19-inch rack and is fastened to the front of the rack by four screws. Capacity is four of any combination of Type FM122 Preamp, Type FM125 Power Supply, Type 360 Indicator, and Type 160-Series Units. (Note: Because the Type FM122 Preamp has high sensitivity, it is recommended that it be mounted at least 4 inches to the left of the Type FM125 Power Supply, order 014-0002-00

Please refer to Terms and Shipment, General Information page.

TYPE 127

PLUG-IN UNIT POWER SUPPLY

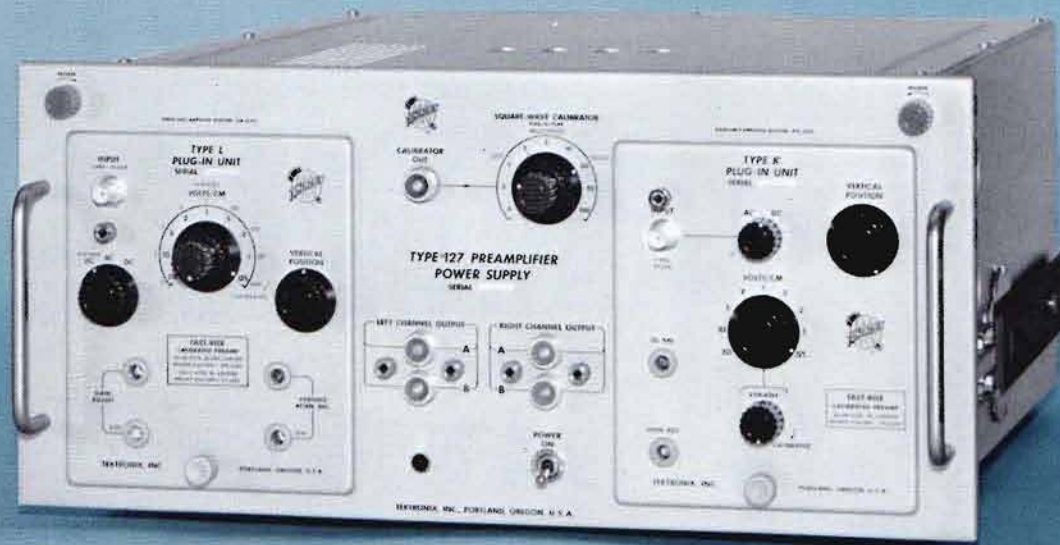

- **ACCEPTS MULTI-TRACE, DIFFERENTIAL, SPECTRUM ANALYZER, AND SAMPLING, PLUG-IN UNITS**
- **DC-to-19 MHz BANDWIDTH**

The Tektronix Type 127 Preamplifier Power Supply provides operating power to one or any combination of two Tektronix Letter Series or "1" Series Plug-In Units. This permits the operation of Tektronix Plug-Ins separate from the oscilloscope in which they are normally used. For example, a double-differential dual-trace display can be obtained with a Type 127 and two Type 1A5, 1A6, 1A7A or G Plug-In Units—when used in conjunction with a dual-trace oscilloscope.

Triggering Signal Inputs are provided at the rear of the instrument to permit the introduction of triggering pulses into a Type CA, 1A1, 1A2, M, or 1A4 Unit to utilize the alternate-sweep features of these multitrace units. The triggering pulses may be obtained from the + GATE OUT terminal of the associated oscilloscope.

Spectrum Analyzer Units require an external sweep voltage (positive going from 0 to at least +90 V). This can be supplied from a Type T Time Base Unit in one compartment, or from an associated oscilloscope with this signal output.

CHARACTERISTICS

BALANCED OUTPUT

The outputs of Plug-In Units powered by the Type 127 are fed through DC-coupled differential amplifier stages and cathode followers to provide a push-pull signal at the output terminals. Push-pull output swing is linear $\pm 3\%$ over a range of ± 0.3 volt into $170\text{-}\Omega$ termination. Output DC operating levels are adjustable to ground potential.

GAIN

The Type 127 has a gain of one, push-pull. With single-ended output, gain is one-half.

OUTPUT TERMINALS

Each channel has four output terminals, two on the front panel and two at the rear. Terminated $170\text{-}\Omega$ output cables are furnished.

AMPLITUDE CALIBRATOR

A squarewave calibration voltage is available through a front-panel coaxial connector. Eighteen fixed voltages—0.2 mV to 100 V, peak to peak (1, 2, 5 sequence). Accuracy is within 3%. Squarewave frequency is approximately 1 kHz.

TYPE 127 TYPICAL PERFORMANCE†

PLUG-IN UNIT	MAXIMUM VOLTAGE GAIN	BANDWIDTH (—3 dB)	RISE-TIME
B	2 20	DC to 15 MHz 2 Hz to 11 MHz	24 ns 32 ns
CA	2	DC to 17 MHz	21 ns
D	100	DC to 300 kHz at a gain of 100, increasing to 2 MHz at a gain of 2	
E	2000	0.06 Hz to 20 kHz at full gain, increasing to 60 kHz at a gain of 200	
G	2	DC to 15 MHz	24 ns
H	20	DC to 12 MHz	30 ns
K	2	DC to 19 MHz	19 ns
L	2 20	DC to 19 MHz 3 Hz to 17 MHz	19 ns 21 ns
M	5	DC to 15 MHz	24 ns
O	2	DC to 17 MHz	21 ns
Q	*	DC to 6 kHz	60 μ s
W	2 100	DC to 16 MHz DC to 7.5 MHz	22 ns 47 ns
Z	2	DC to 11 MHz	32 ns
1A1	2 20 200	DC to 19 MHz DC to 17 MHz 2 Hz to 11 MHz	19 ns 21 ns 32 ns
1A2	2	DC to 19 MHz	19 ns
1A4	10	DC to 19 MHz	19 ns
1A5	20 100	DC to 19 MHz DC to 18 MHz	19 ns 20 ns
1A6	100	DC to 2 MHz	0.18 μ s
1A7A	10,000	DC to 1 MHz	0.35 μ s
1L5	100	10 Hz to 1 MHz	0.35 μ s
1L10	NA**	1 MHz to 36 MHz	NA**
1L20	NA**	10 MHz to 4.2 GHz	NA**
1L30	NA**	925 MHz to 10.5 GHz	NA**
1S1	50	Equiv to DC to 1 GHz	0.35 ns
1S2	20	Equiv to DC to 3.9 GHz	90 ps

*A 10 μ strain input produces a 100 mV output.

**Not applicable.

†Push-pull output terminated in 170 Ω , monitored with DC-to-33 MHz oscilloscope.

POWER REQUIREMENT

105 V to 125 V or 210 V to 250 V, 50 to 60 Hz, 450 watts maximum. Unit factory wired for 117 V. Can be factory wired for 234 V if so indicated on order.

DIMENSIONS AND WEIGHTS

Height	8 $\frac{3}{4}$ in	22.3 cm
Width	19 in	48.3 cm
Depth	21 $\frac{5}{8}$ in	55.0 cm
Net weight	37 $\frac{1}{4}$ lb	16.9 kg
Domestic shipping weight	\approx 71 lb	\approx 32.3 kg
Export-packed weight	\approx 92 lb	\approx 41.9 kg

RACK MOUNTING

Type 127 can be withdrawn from rack on slide-out tracks, tilted and locked in 4 positions. Further mounting information on catalog instrument dimension page.

INCLUDED STANDARD ACCESSORIES

Four 170- Ω terminations (011-0048-00); four 170- Ω coaxial cables (012-0034-00); four BNC-to-UHF adapters (103-0032-00); four UHF-to-BNC adapters (103-0015-00); 3-conductor power cord (161-0010-03); 3 to 2-wire adapter (103-0013-00); pair mounting tracks (351-0085-00); two instruction manuals (070-0284-00).

SUPPORTING CRADLE

For rear slide support when the instrument is to be mounted in a backless rack, includes necessary mounting hardware, order 040-0344-00

Please refer to Terms and Shipment, General Information page.

TYPE 129

PLUG-IN UNIT POWER SUPPLY



- **OPTIONAL CURRENT OR VOLTAGE OUTPUTS**
- **OPERATES UP TO FOUR PLUG-IN UNITS**

The Type 129 Plug-In Supply provides a method of utilizing 2- and 3-Series Amplifier and Time Base Plug-In Units in a wide variety of instrumentation systems. With this power supply, the amplifiers can be used to drive recording equipment, X-Y plotters, oscilloscopes, or other external indicators having requirements within the plug-in unit specifications. The unit is designed to mount in a standard 19 inch rack.

The Type 129 is recommended for use with the 2- and 3-Series single channel low-frequency amplifiers. Multiple-trace plug-ins are usable in the Type 129, but operation should be limited to single-trace modes unless provision is made to operate the multiple-trace switching circuits at a relatively slow rate compatible with the output-circuit bandwidth.

The Type 129 powers up to four 2- and 3-Series plug-in units*, singly or in combination. Each plug-in unit fits into a plug-in compartment having an output connector at the front and rear panels. A selectable cathode-follower or passive circuit card, placed between the plug-in unit and the output connector, controls the output characteristics. All plug-in units that do not have a signal-out provision on the front panel must use one of these cards in order to function properly. Plug-in units with signal-output connectors on the front panel can be used with or without circuit cards.

With the cathode-follower plug-in circuit card installed, push-pull, low impedance signals (to approximately 8 V peak to peak) are available via cathode followers at front and rear connectors. An automatic DC level-setting circuit keeps the average DC level of the two connectors close to 0 V. Bandwidth of the cathode-follower output circuit is DC to approximately 1 MHz.

With the passive card installed, a high-impedance push-pull signal is available at the front panel for balancing and a single-ended signal at low impedance (approximately 500 ohms) is available at the rear output connector. Bandwidth of the passive divider output circuit is DC to approximately 100 kHz and is dependent upon the plug-in used.

Each output can be switched to a meter for DC balance indication. This allows quick setting of the plug-in position control. In addition to the output monitor switch, a two-position switch has been included for balancing of the Type 3C66 Carrier Amplifier Plug-In Unit.

*Sampling plug-ins, designed to operate in pairs (one vertical and one sweep), and Spectrum Analyzer or Automatic "Seeking" plug-ins designed to operate in conjunction with another 2 or 3 series plug-in, must be "paired up" in Channels 1 and 2 or 3 and 4.

TYPICAL APPLICATIONS				
PLUG-IN TYPE	INDICATED DEFLECTION FACTOR	APPROXIMATE SYSTEM GAIN		
		With Passive Output Card*	With CF Output Card**	
			Single Ended	Push-Pull
2A60	50 mV/div	50	20	40
2A61	10 μ V/div (AC)	2.5 X 10 ⁵	10 ⁵	2 X 10 ⁵
2A63	1 mV/div (DC)	2.5 X 10 ³	10 ³	2 X 10 ³
3A3	100 μ V/div	2.5 X 10 ⁴	10 ⁴	2 X 10 ⁴
3A75	50 mV/div	50	20	40
3C66	10 μ strain/div	0.25 V/ μ strain	0.1 V/ μ strain	0.2 V/ μ strain
3L5	To be used with any 2 or 3-Series Time Base to provide 10 Hz to 1 MHz Spectrum Analysis.			
	1 mV/div	2.5 X 10 ³	10 ³	2 X 10 ³
3L10	To be used with any 2 or 3-Series Time Base to provide 1 to 36 MHz Spectrum Analysis.			
3S1/3S2/3S3	2 mV/div (max)	Sampling Amplifier (must be paired with Sampling Time Base).		
3T4/3T77A	0.2 ns/div	Sampling Time Base (must be paired with Sampling Amplifier).		

*Output single ended at rear connector.

**Output at front or rear connector.

In addition to supplying power for the plug-in compartments, the Type 129 provides regulated voltages at a rear-panel connector for powering accessories. Two low-noise fans provide forced-air cooling for the power supply and plug-in compartments.

POWER REQUIREMENTS

Electronically-regulated DC supplies insure stable operation with as much as -10% to $+7\%$ variation from design-center line voltage. The instrument is factory wired to operate at a design center of 117 volts, but a multi-tap transformer permits operation at design centers of 110, 117, 124, 220, 234 or 248 volts, 50 to 60 Hz. Instrument can be ordered factory wired for any of the design centers listed. Power consumption is typically 575 watts maximum under full load.

DIMENSIONS AND WEIGHTS

Height	10½ in	26.8 cm
Width	19 in	48.3 cm
Rack depth	23½ in	59.8 cm
Net weight	49½ lb	22.5 kg
Domestic shipping weight	≈ 83 lb	≈ 37.8 kg
Export-packed weight	≈ 107 lb	≈ 48.6 kg

INCLUDED STANDARD ACCESSORIES

Right-angle power cord (161-0024-01); 3 to 2-wire adapter (103-0013-00); pair of mounting tracks (351-0085-00); two instruction manuals (070-0409-00).

OPTIONAL ACCESSORIES

BLANK PLUG-IN CHASSIS

Contains necessary mechanical parts for construction of a custom plug-in. Includes frame, blank front panel, blank chassis, 24-pin connector, latch and small hardware; electrical components not included. Order 040-0245-00

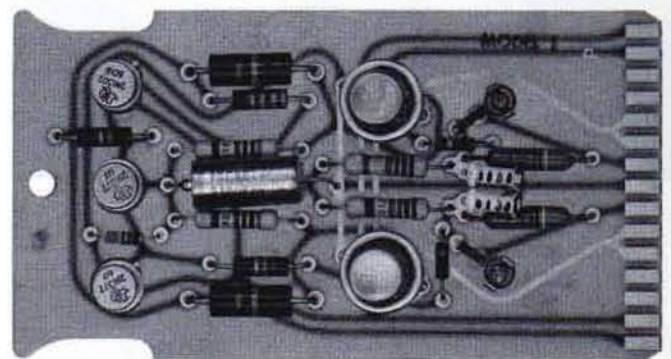

CATHODE-FOLLOWER CIRCUIT CARD
Order 018-0001-00

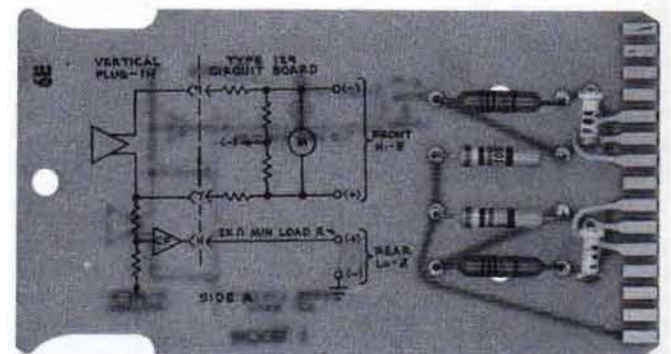

PASSIVE DIVIDER CIRCUIT CARD
Order 018-0002-00

Please refer to Terms and Shipment, General Information page.

TYPE 130

DIRECT-READING L-C METER

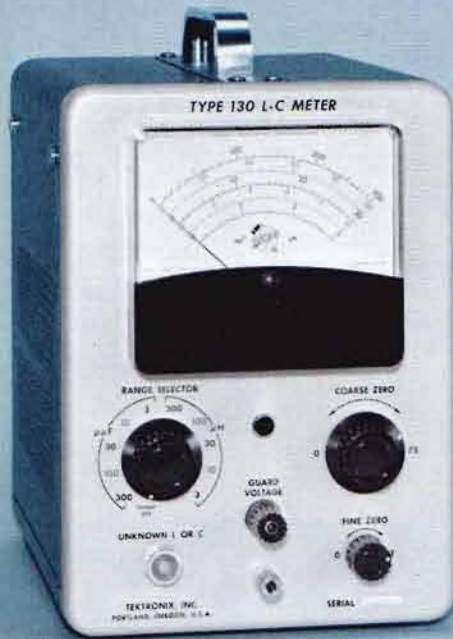

- MEASURES UP TO 300 μ H OR 300 pF
- EASY-TO-READ 4 1/2 INCH METER
- CONVENIENT OPERATION

The Type 130 L-C Meter is a direct-reading reactance meter that measures small reactances in a series mode at a frequency between 125 kHz and 140 kHz. Meter indicates inductance up to 300 μ H and capacitance up to 300 pF. The unknown inductor or capacitor is part of a resonant circuit whose frequency is compared to a 140-kHz reference oscillator. Meter indicates the two oscillator's frequency difference but is calibrated directly in μ H and pF. Measurement of very small reactances is possible by using special measurement procedures that are described in the instrument instruction manual.

The Type 130 is particularly useful for measuring small capacitances in the presence of environmental strays. A front-panel Guard Voltage output connector provides in-phase drive to the environmental capacitance to eliminate strays from the measurement. Thus it is possible to measure vacuum tube interelectrode capacitances. Up to 300 pF environmental capacitance around an unknown capacitor can be guarded if the guard terminal loading is not excessive. Loading limits are outlined in the instruction manual.

Resistance loading compensation is optimized for 117-volts RMS operation. The following loads will not appreciably alter the measurement indication:

Capacitance: as low as 100-k Ω shunt.

Inductance: as low as 20-k Ω shunt, up to 10- Ω series.

Correction tables in instruction manual indicate needed corrections for other values of load resistance. Actual corrections determined for each instrument at time of each recalibration.

RANGE SELECTION

Microhenrys—0 to 3, 10, 30, 100, and 300.

Picofarads—0 to 3, 10, 30, 100, and 300.

ACCURACY

Meter indicates within 3% of full scale. Full scale accuracy of any one range can be improved by special calibration at the time measurement is made.

POWER REQUIREMENTS

40 watts, 50 to 60 Hz. Instrument factory wired for 105 V to 125 V (117 V nominal) operation. Transformer taps permit operation at 210 V to 250 V (234 V nominal). Instrument can be ordered factory wired for 210 V to 250 V operation.

DIMENSIONS AND WEIGHTS

Height	10 5/8 in	27.0 cm
Width	7 in	17.8 cm
Depth	11 1/8 in	28.3 cm
Net weight	9 lb	4.1 kg
Domestic shipping weight	≈14 lb	≈ 6.4 kg
Export-packed weight	≈21 lb	≈ 9.5 kg

INCLUDED STANDARD ACCESSORIES

P93C Probe (010-0003-00); black output lead (012-0014-00); red output lead (012-0015-00); 3-conductor power cord (161-0010-03); 3 to 2-wire adapter (103-0013-00); two instruction manuals (070-0231-01).

OPTIONAL ACCESSORY



PRODUCTION TEST FIXTURE

Reduces production time required to sort and test capacitors and inductors, order 013-0001-00

Please refer to Terms and Shipment, General Information page.

PLUG-IN UNIT POWER SUPPLY



- **ACCEPTS MULTI-TRACE, DIFFERENTIAL, SPECTRUM ANALYZER, AND SAMPLING PLUG-IN UNITS**

- **DC-to-16 MHz BANDWIDTH**

The Type 132 provides an electronically regulated power supply and amplifier for any Tektronix Letter-Series or "1" Series Plug-In Unit.

Convenient front-panel terminals for either push-pull or single-ended output facilitate connections to associated equipment.

CHARACTERISTICS

BANDWIDTH

DC to 16 MHz at 3-dB down, depending on plug-in unit and load impedance. See chart.

GAIN

10 (push-pull) when using a Tektronix Plug-In Unit at 50 mV/cm deflection factor, terminated with a 93- Ω load (approximately 5 into 50- Ω load).

OUTPUT

Push-pull, or single-ended + or - outputs on front panel.

OUTPUT VOLTAGE

Source impedance is ≈ 5 k Ω with ± 10 mA available short circuited. With 93- Ω load, voltage swing is $\approx \pm 1$ V max. No load, voltage is ± 50 V single ended or ± 100 V push-pull.

DUAL-TRACE OPERATION

Back-panel jacks and switching arrangements provide for use of the alternate and chopped modes of operation including blanking, with a Tektronix Multi-Trace Plug-In Unit (1A1, 1A2, CA, 1A4 or M).

POWER REQUIREMENTS

Wired for 105 to 125 VAC (117 V nominal); transformer taps permit operation at 110, 117, 124, 220, 234, or 248 VAC; 50 to 60 Hz. Approx 320-W power consumption. Can be factory wired for any of the above nominal voltages, if so indicated on order.

DIMENSIONS AND WEIGHTS

Height	10 ³ / ₁₆ in	25.9 cm
Width	6 ⁷ / ₈ in	17.5 cm
Depth	18 ¹⁵ / ₁₆ in	48.1 cm
Net weight	21 lb	9.5 kg
Domestic shipping weight	≈ 26 lb	≈ 11.8 kg
Export-packed weight	≈ 33 lb	≈ 15.0 kg

INCLUDED STANDARD ACCESSORIES

Two 93 Ω terminations (011-0056-00); two 93 Ω cables (012-0075-00); 3-conductor power cord (161-0010-03); 3 to 2-wire adapter (103-0013-00); two instruction manuals (070-0288-01).

TYPE 132 TYPICAL PERFORMANCE [†]				
PLUG-IN TYPE	TERMINATED IN 93 Ω		DOUBLE TERMINATED 93 Ω	
	SYSTEM GAIN [‡]	BANDWIDTH	SYSTEM GAIN [‡]	BANDWIDTH
B	100	10 MHz	50	10 MHz
	10	14 MHz	5	16 MHz
CA	10	14 MHz	5	16 MHz
D	10	2 MHz	5	2 MHz
	500	300 kHz	250	300 kHz
E	10,000	See page 280	5000	See Page 280
G	10	14 MHz	5	16 MHz
H	100	11 MHz	50	12 MHz
K	10	14 MHz	5	16 MHz
L	100	14 MHz	50	16 MHz
	10	14 MHz	5	16 MHz
M	10	14 MHz	5	16 MHz
O	10	14 MHz	5	16 MHz
Q		6 kHz		6 kHz
W	500	7 MHz	250	7 MHz
	10	14 MHz	5	16 MHz
Z	10	10 MHz	5	10 MHz
1A1	100	14 MHz	50	16 MHz
1A2	10	14 MHz	5	16 MHz
1A4	50	14 MHz	25	16 MHz
1A5	500	13 MHz	250	15 MHz
	250	14 MHz	125	16 MHz
1A6	500	2 MHz	250	2 MHz
1A7A	Useful to 20,000	1 MHz	Useful to 10,000	1 MHz
1L5	500	1 MHz	250	1 MHz
	Spectrum Analyzer 10 Hz to 1 MHz			
1L10	Spectrum Analyzer 1 MHz to 36 MHz			
1L20	Spectrum Analyzer 10 MHz to 4.2 GHz			
1L30	Spectrum Analyzer 925 MHz to 10.5 GHz			
1S1	250	Equip to 1 GHz	125	Equip to 1 GHz
1S2	100	Equip to 3.9 GHz	50	Equip to 3.9 GHz

[†]Push-pull output, monitored with DC-to-24 MHz oscilloscope.
[‡]System Gain = Overall gain from input of plug-in to the push-pull output cables.
 Spectrum Analyzer Units require an external sweep voltage (positive going from 0 to at least +90 V). This can be supplied from an associated oscilloscope with this output.

Please refer to Terms and Shipment, General Information page.

TYPE 133

PLUG-IN UNIT POWER SUPPLY

- ACCEPTS MULTI-TRACE, DIFFERENTIAL, SPECTRUM ANALYZER, AND SAMPLING PLUG-IN UNITS
- DC-to-100 kHz BANDWIDTH
- 2 Ω SOURCE IMPEDANCE

The Type 133 provides power to an internal, transistorized amplifier and any Tektronix Letter-Series or "1" Series Plug-In Unit. Characteristics of this unit make it particularly useful for driving recorders, and in audio or other low-frequency work.

Connectors on the front-panel enable the output to be fed directly into an oscilloscope or used for other applications.

A typical application of the Type 133 is its use in conjunction with the Tektronix Type Q Transducer and Strain Gage Unit. This combination requires no external equipment other than the strain gages or transducers needed for the particular operation. The output can drive a recorder and be monitored visually at the same time with an oscilloscope. The indicating instrument should have some response at 25 kHz to enable balancing the bridge in the Type Q Unit, otherwise an external monitor must be used.

CHARACTERISTICS

BANDWIDTH

DC to 100 kHz. Specified at -3 dB.

GAIN

10, single-ended.

OUTPUT

±5V (high-impedance load). 1.5 A (short circuit). Source impedance 2 Ω.

DC ADJUST

The output DC operating level adjusts to ground potential.

PHASE INVERSION

An internal switch permits either output polarity.

MONITOR JACK

Allows observation of the output with an oscilloscope without switching cables.

DUAL-TRACE OPERATION

Back-panel jacks and switching arrangements provide for use of the Alternate mode of operation when using a Tektronix Type 1A1, 1A2, CA, 1A4 or M Plug-In Unit.

POWER REQUIREMENTS

Wired for 105 to 125 VAC (117 V nominal); transformer taps permit operation at 110, 117, 124, 220, 234, or 248 VAC; 50 to 60 Hz. Approx 320-W power consumption. Can be factory wired for any of the above nominal voltages, if so indicated on order.

DIMENSIONS AND WEIGHTS

Height	10 ³ / ₁₆ in	25.9 cm
Width	6 ⁷ / ₈ in	17.5 cm
Depth	18 ¹⁵ / ₁₆ in	48.1 cm
Net weight	22 lb	10.0 kg
Domestic shipping weight	~26 lb	~11.8 kg
Export-packed weight	~34 lb	~15.5 kg

INCLUDED STANDARD ACCESSORIES

3-conductor power cord (161-0010-03); 3- to 2-wire adapter (103-0013-00); two instruction manuals (070-0290-00).



TYPE 133 TYPICAL PERFORMANCE

PLUG-IN TYPE	OVERALL GAIN (NO LOAD)	BANDWIDTH (-3 dB)
B	10	DC to 100 kHz
CA	100 (AC only)	2 Hz to 100 kHz
D	10	DC to 100 kHz
E	500	DC to 100 kHz
G	10,000	See E Unit
H	10	DC to 100 kHz
K	100	DC to 100 kHz
L	10	DC to 100 kHz
M	100 (AC only)	3 Hz to 100 kHz
O	10	DC to 100 kHz
Q	10	DC to 6 kHz
W	10 to 500	DC to 100 kHz
Z	10	DC to 100 kHz
1A1	100	DC to 100 kHz
1A2	10	DC to 100 kHz
1A4	50	DC to 100 kHz
1A5	500	DC to 100 kHz
1A6	500	DC to 100 kHz
1A7	50,000	DC to 100 kHz
1L5	SPECTRUM ANALYZER	10 Hz to 1 MHz
	500	10 Hz to 100 kHz
1L10	SPECTRUM ANALYZER	1 MHz to 36 MHz
1L20	SPECTRUM ANALYZER	10 MHz to 4.2 GHz
1L30	SPECTRUM ANALYZER	925 MHz to 10.5 GHz
1S1	250	DC to 1 GHz
1S2	100	DC to 3.9 GHz

Spectrum Analyzer Units require an external sweep voltage (positive going from 0 to at least +90 V). This can be supplied from an associated oscilloscope with this output.

Please refer to Terms and Shipment, General Information page.

TYPE 160A

POWER SUPPLY



- **REGULATED VOLTAGES**
- **LARGE LOAD CAPACITY**
- **POWERS UP TO SEVEN INSTRUMENTS**

The Type 160A Power Supply provides the required currents and voltages for one Type 360 Indicator Unit in combination with up to six Type 160-Series Generators. Power capability handles up to five Type 360 Indicator Units, up to five Type 163 Fast-Rise Pulse Generators, up to seven Type 162 Waveform Generators, or up to seven Type 161 Pulse Generators.

Electronic regulation compensates for line-voltage variations between 105 and 125 V or 210 and 250 V, and for current-demand differences between instruments.

POWER OUTPUT

REGULATED: +225 V DC at 175 mA with no shunt across the series regulator, increasing to a maximum of 225 mA with a 1500-ohm shunt; +150 V DC at 15 mA; -170 V DC at 125 mA.

UNREGULATED: +300 V DC at 50 mA to 275 mA depending on the current drawn from the regulated +225 V supply; +80 V DC up to 50 mA depending on the current drawn from the regulated -170 V supply; 6.3 V AC at 20 A.

OUTPUT CONNECTORS

Four octal sockets mounted on rear panel.

POWER REQUIREMENTS

350 watts, 50 to 60 Hz. Unit factory wired for 105 V to 125 V (117-V nominal) operation. Transformer taps permit operation at 210 V to 250 V (234-V nominal). Instrument can be ordered factory wired for 210 V to 250 V operation.

DIMENSIONS AND WEIGHTS

Height	12 $\frac{1}{4}$ in	31.1 cm
Width	4 $\frac{1}{8}$ in	10.5 cm
Depth	14 $\frac{3}{8}$ in	36.6 cm
Net weight	20 lb	9.1 kg
Domestic shipping weight	≈26 lb	≈11.8 kg
Export-packed weight	≈44 lb	≈20.0 kg

INCLUDED STANDARD ACCESSORIES

Two inter-unit power cables (012-0016-00); 3-conductor power cord (161-0010-03); 3 to 2-wire adapter (103-0013-00); mounting hardware; instruction manual (070-0220-00).

OPTIONAL ACCESSORIES

MOUNTING FRAME

Adapts Type 160A to standard 19 inch rack. Mounts up to four Type 160-Series instruments or up to three Type 160-Series instruments and a Type 360 Indicator Unit. Occupies 12 $\frac{1}{4}$ inches rack space, order 014-0002-00

BLANK PANEL

For above mounting frame, occupies same panel area as one instrument, order 333-0157-00

Please refer to Terms and Shipment, General Information page.

TYPE 161

PULSE GENERATOR

- VARIABLE PULSE DELAY
- VARIABLE WIDTH AND AMPLITUDE
- SEPARATE GATE AND PULSE OUTPUTS
- ± 50 -V OUTPUT AMPLITUDE

The Tektronix Type 161 Pulse Generator is designed to supply calibrated rectangular output pulses from zero to 50-V amplitude (positive or negative polarity) and $10 \mu\text{s}$ to 100 ms duration when an external trigger of required voltage is received. An excellent trigger source is the Type 162 Waveform Generator. The 50-V Gate Output has the same duration and timing as the pulse output, but is of fixed amplitude.

When triggered by a negative-going sawtooth, the output pulse and gate can be adjusted to occur at designated points along the sawtooth. A calibrated control indicates output delay as a fraction of the triggering sawtooth duration. Other calibrated controls indicate pulse and gate width (in milliseconds) and pulse amplitude (in volts). When triggered by a positive pulse, the same output waveforms are available. In this instance the delay control functions as a triggering-level selector.

Voltages necessary to operate the Type 161 can be obtained from the Type 160A Power Supply, which can power up to seven Type 161 Generators.

OUTPUT WAVEFORMS

Variable-amplitude positive or negative pulse. Fixed-amplitude positive gate.

OUTPUT CHARACTERISTICS

Risetime—Positive pulse; within $0.5 \mu\text{s}$ when load capacitance is 10 pF or less, within $0.75 \mu\text{s}$ for 100 pF or less load capacitance. Negative pulse; within $0.5 \mu\text{s}$ when load capacitance is 10 pF or less, within $1.5 \mu\text{s}$ for 100 pF or less load capacitance. Overshoot less than 5%.

Duration—calibrated, variable, $10 \mu\text{s}$ to 0.1 s.

Delay—continuously variable, 0 to 100% of triggering sawtooth waveform.

AMPLITUDE

Pulse—calibrated, continuously variable, 0 to 50 V, peak to peak. Front panel switch provides positive or negative polarity.

Gate—fixed, 50-V positive, peak to peak minimum.

OUTPUT IMPEDANCE

Positive pulse—1.8 kilohms maximum.

Negative pulse—5 kilohms approximately.

Positive gate—1 kilohm maximum.

TRIGGER REQUIREMENTS

Positive pulse, 3 V peak to peak minimum. Negative-going sawtooth; must include DC bias sufficient to keep voltage positive. Maximum repetition rate, 50 kHz.



POWER REQUIREMENTS

-170 V DC at 17 mA +225 VDC at 22 mA, 6.3 VAC at 1.65 A.

DIMENSIONS AND WEIGHTS

Height	12 $\frac{1}{4}$ in	31.2 cm
Width	4 $\frac{1}{8}$ in	10.5 cm
Depth	6 $\frac{3}{8}$ in	16.2 cm
Net weight	3 $\frac{1}{2}$ lb	1.6 kg
Domestic shipping weight	≈ 8 lb	≈ 3.6 kg
Export-packed weight	≈ 14 lb	≈ 6.4 kg

INCLUDED STANDARD ACCESSORIES

Inter-unit cable (012-0017-00); mounting hardware; instruction manual (070-0220-00).

OPTIONAL ACCESSORIES

MOUNTING FRAME

Adapts Type 161 to standard 19-inch rack. Mounts up to four Type 160-Series instruments or up to three Type 160-Series instruments and a Type 360 Indicator Unit. Occupies 12 $\frac{1}{4}$ inches rack space, order 014-0002-00

BLANK PANEL

For above mounting frame, occupies same panel area as one instrument, order 333-0157-00

Please refer to Terms and Shipment, General Information page.

WAVEFORM GENERATOR

- **PULSE OR GATE AND SAWTOOTH OUTPUT**
- **VARIABLE WAVEFORM DURATION AND PULSE INTERVAL**
- **5 OPERATING MODES**

The Type 162 Waveform Generator produces three types of calibrated output waveforms. Both the duration and repetition rate of the output waveforms—pulse, gate, and sawtooth—are adjustable. Triggering can occur from an external electrical impulse or by front-panel pushbutton. The unit is designed to operate as a delay generator in conjunction with the Type 161 or Type 163, and to supply a sweep voltage for the Type 360 Indicator Unit. It is useful for initiating chains of events electrically, for controlling their duration and repetition rate, and for generating waveforms recurrently. As such it is a stable repetition rate generator.

Voltages necessary to operate the Type 162 can be obtained from the Type 160A Power Supply, which can power up to seven Type 162 Generators.



OUTPUT WAVEFORMS

Positive pulse, positive gate, and negative-going positive sawtooth.

OUTPUT CHARACTERISTICS

Pulse Risetime—1 μ s or less.

Duration—pulse, 10 μ s to 0.05 s; gate and sawtooth, 100 μ s to 10 s.

Repetition Rate—0.1 Hz to 10 kHz, recurrent operation.

AMPLITUDE

Pulse and gate are fixed, positive, 50-V peak to peak minimum. Sawtooth decreases linearly with time from $\geq +145$ V to $\leq +25$ V.

OUTPUT IMPEDANCE

Approximately 1000 ohms for all outputs.

TRIGGER REQUIREMENTS

Positive pulse—15 V. Positive gate—8 V. Sinewave—6 V RMS, frequency from 5 Hz to 50 kHz.

POWER REQUIREMENTS

—170 V DC at 7 mA, +150 V DC at 1 mA. +225 V DC at 28 mA, 6.3 V AC at 1.7 A.

DIMENSIONS AND WEIGHTS

Height	12 $\frac{1}{4}$ in	31.2 cm
Width	4 $\frac{1}{8}$ in	10.5 cm
Depth	6 $\frac{3}{8}$ in	16.2 cm
Net weight	3 $\frac{1}{2}$ lb	1.6 kg
Domestic shipping weight	\approx 8 lb	\approx 3.6 kg
Export-packed weight	\approx 14 lb	\approx 6.4 kg

INCLUDED STANDARD ACCESSORIES

Inter-unit power cable (012-0017-00); mounting hardware; instruction manual (070-0220-00).

OPTIONAL ACCESSORIES

MOUNTING FRAME

Adapts Type 162 to standard 19-inch rack. Mounts up to four Type 160-Series instruments or up to three Type 160-Series instruments and a Type 360 Indicator Unit. Occupies 12 $\frac{1}{4}$ inches rack space, order 014-0002-00

BLANK PANEL

For above mounting frame, occupies same panel area as one instrument, order 333-0157-00

Please refer to Terms and Shipment, General Information page.

TYPE 163

PULSE GENERATOR

- 0.2 μs RISETIME
- VARIABLE PULSE DELAY
- VARIABLE WIDTH AND AMPLITUDE
- SEPARATE GATE AND PULSE OUTPUT

The Tektronix Type 163 Pulse Generator is designed to supply rectangular output pulses from 0 to 25 V in amplitude and 1 μs to 10 ms in duration, when an external trigger of required voltage is received. An excellent trigger source is the Type 162 Waveform Generator. The 25-V Gate Output of the Type 163 has the same characteristics as the pulse, but is of fixed amplitude.

When triggered by a negative-going sawtooth, the output pulse and gate can occur at designated points along the sawtooth. A calibrated control indicates output delay as a fraction of the triggering sawtooth duration. Other calibrated controls indicate pulse and gate width (in microseconds) and pulse amplitude (in volts).

The Type 163 operates up to 50% duty cycle at the minimum time setting on any range. With higher multiplier-control settings, the duty cycle can be correspondingly higher. Maximum repetition rate is 500 kHz—with a generated pulse of 1- μs duration.

Voltages necessary to operate the Type 163 can be obtained from the Type 160A Power Supply, which can power up to five Type 163 Generators.

OUTPUT WAVEFORMS

- Variable-amplitude positive pulse.
- Fixed-amplitude positive gate.

OUTPUT CHARACTERISTICS

Risetime—Within 0.2 μs when load capacitance is 10 pF or less, within 0.25 μs for 100 pF or less load capacitance.

Overshoot can be adjusted to zero.

Duration—calibrated, variable, 1 μs to 10 ms.

Delay—continuously variable, 0 to 100% of triggering sawtooth duration.

Decay Time—0.2 to 0.5 μs .

AMPLITUDE

Pulse—calibrated, continuously variable, 0 to 25 V, peak to peak.

Gate—fixed, positive, 25 V minimum, peak to peak.

OUTPUT IMPEDANCE

Pulse—500 ohms (varies with pulse-amplitude control setting).

Gate—100 ohms.

Minimum load resistance—3.5 kilohms.

TRIGGER REQUIREMENTS

Positive pulse, 2 V peak to peak minimum.

Negative-going sawtooth; must include DC bias sufficient to keep voltage positive. Maximum repetition rate, 500 kHz.



POWER REQUIREMENTS

—170 V DC at 25 mA, +225 V DC at 45 mA. 6.3 V AC at 3.6 A.

DIMENSIONS AND WEIGHTS

Height	12 $\frac{1}{4}$ in	31.2 cm
Width	4 $\frac{1}{8}$ in	10.5 cm
Depth	6 $\frac{3}{8}$ in	16.2 cm
Net weight	3 $\frac{1}{2}$ lb	1.6 kg
Domestic shipping weight	≈ 8 lb	≈ 3.6 kg
Export-packed weight	≈ 14 lb	≈ 6.4 kg

INCLUDED STANDARD ACCESSORIES

Inter-unit power cable (012-0017-00); mounting hardware; instruction manual (070-0220-00).

OPTIONAL ACCESSORIES

MOUNTING FRAME

Adapts Type 163 to standard 19-inch rack. Mounts up to four Type 160-Series instruments or up to three Type 160-Series instruments and a Type 360 Indicator Unit. Occupies 12 $\frac{1}{4}$ inches rack space, order 014-0002-00

BLANK PANEL

For above mounting frame, occupies same panel area as one instrument, order 333-0157-00

Please refer to Terms and Shipment, General Information page.

INDICATOR

- **DC TO 500 kHz BANDWIDTH**
- **0.05 V/DIV TO 50 V/DIV DEFLECTION FACTOR**

The Type 360 Indicator Unit in combination with the Type 160-Series Instruments becomes an integral building block in a complex sequence control and monitoring system.

The compact indicator contains a flat-faced, 3-inch cathode-ray tube, accelerating-voltage supply, horizontal amplifier, vertical amplifier and a calibrated vertical attenuator, among other features. It is designed to receive its sweep and unblanking voltages from a Type 162 Waveform Generator.

Any source of proper voltage and waveforms can power the indicator. The Type 160A Power Supply is recommended for applications that require a compact rack-mounted combination. In system use, up to 5 Type 360 Indicator Units can operate from a single Type 160A Power Supply.

VERTICAL DEFLECTION

BANDWIDTH

DC to 500 kHz at 3-dB down.

DEFLECTION FACTOR

0.05 V/div, 0.5 V/div, 5 V/div and 50 V/div. Continuously variable between steps.

INPUT RC

1 megohm paralleled by approx 40 pF.

MAXIMUM INPUT VOLTAGE

600 V combined DC + peak AC.

HORIZONTAL DEFLECTION

WAVEFORMS REQUIRED

Positive or negative-going sawtooth: 110 to 150 V excursion within the limits of -95 V to +170 V.

Unblanking gate: 45 to 75 V positive, same duration as the sawtooth.

BANDWIDTH

DC to 100 kHz at 3-dB down.

CRT

TEKTRONIX CRT

A flat-faced 3-inch cathode-ray tube provides a bright trace. Accelerating potential is 1.5 kV. A P2 phosphor is normally supplied. Z-axis input is DC-coupled to the grid and requires at least 45 V to unblank CRT.

GRATICULE

External, illuminated, marked in eight vertical and ten horizontal one-fourth inch major divisions. Center lines are further marked in five minor divisions per major division.

OTHER CHARACTERISTICS

POWER REQUIREMENTS

+300 V DC at 20 mA unregulated; +225 V DC at 35 mA regulated; -170 V DC at 23 mA regulated; 6.3 V AC at 3.5 A.

INCLUDED STANDARD ACCESSORIES

Inter-unit power cable (012-0016-00); smoke-gray filter (378-0550-00); mounting hardware; instruction manual (070-0220-00).



DIMENSIONS AND WEIGHTS

Height	12 $\frac{1}{4}$ in	31.2 cm
Width	4 $\frac{1}{8}$ in	10.5 cm
Depth	14 in	35.6 cm
Net weight	9 $\frac{3}{4}$ lb	4.4 kg
Domestic shipping weight	≈16 lb	≈7.3 kg
Export-packed weight	≈26 lb	≈11.8 kg

OPTIONAL ACCESSORIES

MOUNTING FRAME

Adapts Type 360 to a standard 19-in rack. Mounts up to four Type 360 Indicator Units or up to three Type 160-Series instruments and one Type 360. Occupies 12 $\frac{1}{4}$ inches of rack space, order 014-0002-00

BLANK PANEL

For above mounting frame, occupies same panel area as one instrument, order 333-0157-00

C-30 CAMERA

f/1.9 lens, variable magnification; Polaroid Land* Pack-Film back

Type 360 to C-30 Camera Adapter, order 016-0241-00

PROBES

P6006 10X Probe Package, order 010-0125-00

P6007 100X Probe Package, order 010-0134-00

P6027 1X Probe Package, order 010-0070-00

*Registered Trade-Mark Polaroid Corporation

Please refer to Terms and Shipment, General Information page.

TYPE 184

TIME-MARK GENERATOR

- 16 MARKER INTERVALS, 5 SINEWAVE FREQUENCIES
- 500-MHz SINEWAVE OUTPUT
- CRYSTAL-CONTROLLED OSCILLATOR

The Type 184 is a compact, wide-range time-mark generator. It is CRYSTAL-CONTROLLED and provides 16 MARKER INTERVALS, 5 SINEWAVES FREQUENCIES, and 7 TRIGGER-PULSE INTERVALS.

Marker pushbuttons are self-canceling so that when any marker button is pushed, other buttons are automatically released. More than one marker interval (up to two decades apart) can be obtained at one time by pushing the desired buttons simultaneously. Triggers are time-coincident with the corresponding markers.

The Type 184 is transistorized (plus 6 nuvistors) and is frequency controlled by a temperature-stabilized 10-MHz crystal oscillator. This instrument gives you great versatility for many laboratory or production-line applications.

OUTPUT CHARACTERISTICS

CRYSTAL-CONTROLLED OSCILLATOR

10 MHz $\pm 0.001\%$ from 20°C to 30°C, 10 MHz $\pm 0.002\%$ from 0°C to +50°C within 5 minutes after instrument turn on, when instrument has been plugged in for 2 hours. Stability within 3 P/M in 24 hours from 20°C to 30°C, after 2 h continuous operation and 72 h initial aging operation.

MARKER OUTPUT

Positive-going markers with 16 intervals of 100 ns to 5 s in 1-5-10 sequence, 1-V minimum peak amplitude into 50 ohms.

MARKER AMPLIFIER OUTPUT

Positive- or negative-going markers with 14 intervals of 1 μ s to 5 s in 1-5-10 sequence, 25-V minimum amplitude into 1 k Ω .

SINEWAVE OUTPUTS

10-ns, 20-ns, and 50-ns sinewave signals at Marker Output connector with 1-V minimum peak to peak amplitude into 50 ohms. 2-ns and 5-ns sinewave signals at HF output connector with 0.3-V minimum peak to peak amplitude into 50 ohms.

TRIGGER OUTPUT

Positive-going pulses with 7 intervals of 1 μ s to 1 s in 1-10 sequence, 0.4-V minimum amplitude into 50 ohms, 2.5 V minimum amplitude into open circuit.

OTHER CHARACTERISTICS

POWER REQUIREMENTS

94.5 V to 137.5 V or 189 V to 275 V, low or high range selected by rear-panel switch. 50 to 400 Hz, approx 40 watts.

DIMENSIONS AND WEIGHTS

Height	6 $\frac{3}{4}$ in	17.2 cm
Width	9 in	22.9 cm
Depth	16 $\frac{1}{8}$ in	41 cm
Net weight	13 lb	5.9 kg
Domestic shipping weight	\approx 19 lb	\approx 8.7 kg
Export-packed weight	\approx 30 lb	\approx 13.6 kg



INCLUDED STANDARD ACCESSORIES

Two 50- Ω BNC cables (012-0057-01); 50- Ω BNC termination (011-0049-00); right-angle, 3-conductor power cord (161-0024-01); 3 to 2-wire adapter (103-0013-00); two instruction manuals (070-0499-00). (Power cord for MOD 146B is 161-0031-00).

TYPE 184 TIME-MARK GENERATOR MOD 146B

As above, but less cabinet, for mounting in rack adapter.

RACK ADAPTER FOR TYPE 106, 114, 184, 191 and 284

Converts these generators for rack mounting. Any combination of two of these instruments can be mounted side by side in a 19-inch rack, in only 5 $\frac{1}{4}$ inches of panel height. Up to four Type 284's can be mounted side-by-side, or two Type 284's can be mounted with one of the other generators. Adapter provides forced-air ventilation and shielding between compartments. Blank panels are available to cover unused opening when only one generator is installed. Special power cord (161-0031-00) is required for each instrument installed. Blank panels and special power cords are not supplied with the rack adapter.

RACK MOUNT (016-0086-01)

1/2-WIDTH BLANK PANEL (016-0081-00)

1/4-WIDTH BLANK PANEL (016-0109-00)

SPECIAL POWER CORD (161-0031-00)

Please refer to Terms and Shipment, General Information page.

CONSTANT-AMPLITUDE SIGNAL GENERATOR

- 350-kHz to 100-MHz SINEWAVES
- 5-mV to 5.5-V CONSTANT AMPLITUDE
- 50-kHz AMPLITUDE REFERENCE

The Type 191 is a variable-frequency sinewave generator with a constant-amplitude output over the entire frequency range. Both output amplitude and frequency are calibrated. Amplitude is held constant during frequency variations by continuous sampling of peak-to-peak voltage.

OUTPUT CHARACTERISTICS

FREQUENCY RANGE

Continuously variable and calibrated in 7 ranges from 350 kHz to 100 MHz, plus 50-kHz reference output. Accuracy within $\pm 2\%$ of selected frequency with output terminated in $50\ \Omega$ or unterminated (except $\pm 5\%$ on 0.5-5 V range with output unterminated).

AMPLITUDE RANGE

5 mV to 5 V peak to peak in 3 ranges (10 calibrated steps per range) into $50\ \Omega$ termination. Unterminated output is 2X indicated output. Amplitude is continuously variable (uncalibrated) between steps and to 10% over the top of each range (5.5 V terminated or 11 V unterminated).

AMPLITUDE ACCURACY

50-kHz reference output accurate within $\pm 3\%$ of indicated amplitude on 0.5-5 V range, $\pm 4\%$ on 50-500 mV range, and $\pm 5\%$ on 5-50 mV range, into $\pm 1\%$ $50\ \Omega$ termination. Accuracy improved with a more accurate termination. Unterminated output is 2X indicated amplitude, at same accuracy. When the frequency is varied from 350 kHz to 100 MHz, the output amplitude into $50\ \Omega$ (at the output connector or through no more than 5 ns of RG8 cable) will not vary more than $\pm 3\%$ from actual amplitude at 50 kHz, except when using the 5-mV to 50-mV range the output may vary $+3\%$ - 5% on frequencies from 42 MHz to 100 MHz.

HARMONIC CONTENT

Typically less than 5%.

OTHER CHARACTERISTICS

POWER REQUIREMENTS

103.5 V to 126.5 V or 207 V to 253 V, low or high range selected by rear-panel switch. 50 to 400 Hz, 25 watts maximum.

DIMENSIONS AND WEIGHTS

Height	6 ³ / ₄ in	17.1 cm
Width	9 in	22.8 cm
Depth	15 ³ / ₄ in	40 cm
Net weight	14 lb	6.4 kg
Domestic shipping weight	≈ 20 lb	≈ 9.1 kg
Export-packed weight	≈ 31 lb	≈ 14.1 kg

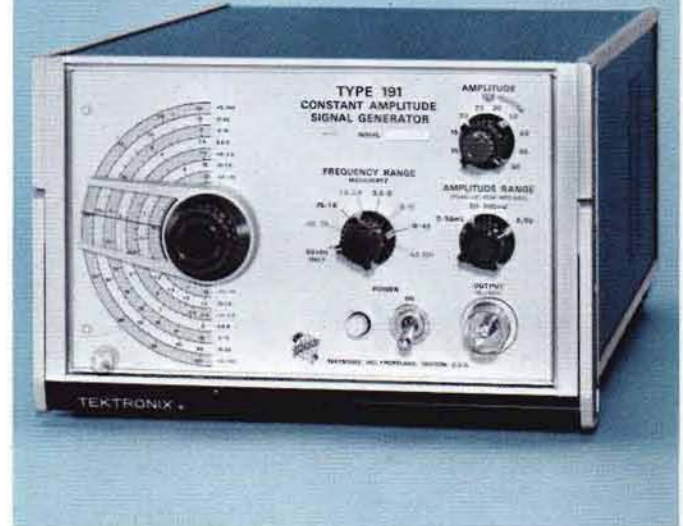

INCLUDED STANDARD ACCESSORIES

5-ns cable (017-0502-00); 50- Ω GR to BNC in-line termination (017-0083-00); right-angle 3-conductor power cord (161-0024-01); 3 to 2-wire adapter (103-0013-00); two instruction manuals (070-0522-00); (power cord for MOD 146B is 161-0031-00).

TYPE 191 MOD 146B CONSTANT-AMPLITUDE SIGNAL GENERATOR

As above, but less cabinet, for mounting in rack adapter.

RACK ADAPTER FOR TYPE 106, 114, 184, 191 and 284

Converts these generators for rack mounting. Any combination of two of these instruments can be mounted side by side in a 19-in rack, in only 5¹/₄ inches of panel height. Up to four Type 284's can be mounted side-by-side, or two Type 284's can be mounted with one of the other generators. Adapter provides forced-air ventilation and shielding between compartments. Blank panels to cover unused opening are available when only one generator is installed. Special power cord (161-0031-00) is required for each instrument installed. Blank panels and special power cords are not supplied with the rack adapter.

RACK ADAPTER (016-0086-01)

1/2-WIDTH BLANK PANEL (016-0081-00)

1/4-WIDTH BLANK PANEL (016-0109-00)

SPECIAL POWER CORD (161-0031-00)

Please refer to Terms and Shipment, General Information page.

TYPE 281

TIME-DOMAIN REFLECTOMETER PULSER



The Type 281 Time-Domain Reflectometer Pulser is designed for use with Tektronix Type 1S1, 3S1, and 4S1 Sampling Plug-ins. It converts these general-purpose sampling plug-ins to an easy-to-use TDR system. Power is obtained from their probe power connector.

FEED-THROUGH OUTPUT allows Type 281 to be connected directly between oscilloscope input and TDR test-line. Pulse injection is from non-loading current source ($\leq 10\%$ capacitive reflection of 750-ps step). GR874 connectors.

RISETIME is less than or equal to 750 ps at negative transition.

AMPLITUDE is approximately 460 mV (both connectors terminated in 50 Ω).

WIDTH is greater than or equal to 5 μ s from negative-going edge to positive-going edge, at 50% amplitude points.

ABERRATIONS are $\pm 2\%$ or less in first 10 ns following the negative transition, $\pm 0.5\%$ after 10 ns.

TYPE 281 TDR PULSER, order 015-0060-00

Each instrument includes: 2—instruction manuals (070-0515-00).

Please refer to Terms and Shipment, General Information page.

TYPE 282

PROBE ADAPTER



The Type 282 permits the use of conventional high-impedance probes with 50- Ω sampling plug-in units, such as Types 1S1, 3S1, 4S1, and 4S2A. Power is obtained from their probe power connector.

Features of sampling such as DC offset, smoothing and overload recovery not normally available with a conventional oscilloscope are combined with the convenience of a high-impedance probe.

RISETIME is 3 ns or less.

GAIN is unity $\pm 3\%$, non-inverting.

INPUT RESISTANCE is 1 megohm.

INPUT CAPACITANCE is approximately 17 pF.

DYNAMIC RANGE is +750 mV to -750 mV into 50 Ω .

MAXIMUM INPUT is ± 5 V (DC + peak AC).

CHARACTERISTICS REFERRED TO PROBE TIP

Probe	Overall Risetime	Input RC	Dynamic Range	Deflection Factor	Offset
P6008 (10X)	≈ 4 ns	10 M Ω , 7.5 pF	± 7.5 V	20 mV/cm to 2 V/cm	± 10 V
P6009 (100X)	≈ 3.5 ns	10 M Ω , 2.5 pF	± 75 V	200 mV/cm to 20 V/cm	± 100 V
P6010 (10X)	≈ 3.5 ns	10 M Ω , 10 pF	± 7.5 V	20 mV/cm to 2 V/cm	± 10 V
P6011* (1X)	≈ 12 ns	1 M Ω , 42 pF	± 0.75 V	2 mV/cm to 200 mV/cm	± 1 V
P6047 (10X)	2.5 ns	10 M Ω , 10 pF	± 7.5 V	20 mV/cm to 2 V/cm	± 10 V

*Care must be used to avoid exceeding the ± 5 V max input limits of the Type 282.

TYPE 282 PROBE ADAPTER, order 015-0074-00

Each instrument includes: 2—instruction manuals (070-0544-00).

Please refer to Terms and Shipment, General Information page.

PULSE GENERATOR

NEW



- **PULSE OUTPUT WITH ≤ 70 -ps RISETIME**
- **SINE WAVE AND SQUARE WAVE OUTPUTS**
- **COMPACT, SOLID-STATE DESIGN**

The new Type 284 Pulse Generator provides the facility for verifying the performance of Sampling Oscilloscopes. This new generator offers, in one small instrument, all of the signals required to check the risetime, vertical deflection factors, and horizontal sweep rates. A pre-trigger output is also incorporated.

In addition to checking the transient response of sampling oscilloscopes, the fast-rise step of the pulse output is an excellent signal source for TDR measurements. The Type 284 is available in a cabinet version, or modified for rackmounting in standard 19-inch rack using the optional Rack Adapter.

OUTPUT CHARACTERISTICS

PULSE OUTPUT

70 ps or less risetime with a pulse width of 1 μ s and a repetition rate of 50 kHz. Aberrations immediately following positive-going transitions are less than $\pm 3\%$, 3% total peak-to-peak; after 2 ns, less than $\pm 2\%$, 2% total peak-to-peak. Pulse amplitude is approx +200 mV into 50 ohms. Source impedance is 50 ohms.

SQUARE WAVE OUTPUT

Periods of 10 μ s, 1 μ s or 100 ns. Output amplitude is 10 mV, 100 mV or 1 V into 50 ohms.

SINE WAVE OUTPUT

Periods of 10 ns or 1 ns. Output amplitude is 100 mV into 50 ohms.

TRIGGER OUTPUT

Amplitude is 200 mV. With PULSE OUTPUT, trigger risetime is 3 ns and occurs either 5 ns or 50 ns before positive-going transition.

TIMING AND AMPLITUDE ACCURACY

OUTPUT	PERIOD	TIMING ACCURACY	AMPLITUDE ACCURACY		
			1 V	100 mV	10 mV
Pulse	20 μ s	$\pm 10\%$			
Square Wave	10 μ s	$\pm 0.5\%$	$\pm 0.5\%$	$\pm 1\%$	$\pm 1.5\%$
	1 μ s	$\pm 0.05\%*$	$\pm 2\%^\dagger$	$\pm 2.5\%^\dagger$	$\pm 3\%^\dagger$
Sine Wave	10 ns	$\pm 1\%$		$\pm 20\%$	
	1 ns				

* crystal controlled

† 20 ns after transition

OTHER CHARACTERISTICS

POWER REQUIREMENTS

6.5 watts, 45 Hz to 440 Hz. Quick-change line-voltage selector permits operation from 90 V to 136 V or 180 V to 272 V.

DIMENSIONS AND WEIGHTS

Height	6 $\frac{3}{4}$ in	17.2 cm
Width	4 $\frac{1}{2}$ in	11.4 cm
Depth	15 in	38.1 cm
Net Weight	8 $\frac{1}{2}$ lb	3.8 kg
Domestic Shipping Weight	$\approx 15\frac{1}{2}$ lb	≈ 7.1 kg
Export-packed Weight	≈ 20 lb	≈ 9.1 kg

INCLUDED STANDARD ACCESSORIES

BNC cable (012-0057-01); right angle 3-conductor power cord (161-0024-01); 3 to 2-wire adapter (103-0013-00); instruction manual (070-0754-00).

TYPE 284 MOD 146B

As above, but less cabinet for mounting in Rack Adapter.

RACK ADAPTER FOR TYPE 284

Adapts the Type 284 MOD 146B for rackmounting in a 19-inch rack, in only 5 $\frac{1}{4}$ inches of panel height. The Type 284 occupies $\frac{1}{4}$ -rack width. Up to four Type 284's can be mounted side-by-side, or two Type 284's can be mounted along side one $\frac{1}{2}$ -rack width generator, such as the Type 106 Square-wave Generator, 114 Pulse Generator, 184 Time-Mark Generator, or 191 Constant-Amplitude Generator. The Adapter provides forced-air ventilation and shielding between compartments. Blank panels are available to cover the unused openings when the adapter is not filled. A divider kit and special power cord are required for each Type 284 installed. Blank panels, divider kits, and special power cords are not included with the Rack Adapter.

RACK ADAPTER (016-0086-01)

$\frac{1}{2}$ -WIDTH BLANK PANEL (016-0081-00)

$\frac{1}{4}$ -WIDTH BLANK PANEL (016-0109-00)

DIVIDER KIT (016-0089-00)

SPECIAL POWER CORD (161-0031-00)

Please refer to Terms and Shipment, General Information page.

TYPE R293

PROGRAMMABLE PULSE GENERATOR and POWER SUPPLY



PROGRAMMABLE PARAMETERS

- **PULSE AMPLITUDE**—6 V to 12 V into 50 Ω
- **PULSE WIDTH**—2 ns to 250 ns into 50 Ω
- **PULSE REPETITION RATE**—10 kHz to \approx 100 kHz
- **REGULATED VOLTAGE**—0 to 50 V
- **REGULATED CURRENT**—0 to 250 mA

The Type R293 is a combination pulse generator and power supply which may be used in testing time and charge parameters of semiconductor devices, testing switching and propagation times of micro-logic circuits, or in a wide variety of applications which require fast-rise and fast-fall pulses. Remote programming capabilities make the instrument useful in production line and systems applications.

Programming is accomplished by connecting resistances between appropriate program leads. One resistor per program is required for each of the five programmable functions. The value for each programmed function is linearly related to the conductance of its respective programming resistor. Any single or combination of programmable parameters can be externally programmed, with remaining parameters manually controlled from the front panel.

As an example, programmable parameters can be remotely controlled (automatic sequence optional) with the Type 262 Programmer. The Type 567 Readout Oscilloscope and Type 6R1A Digital Unit may be used to display the results of each measurement and indicate whether results are within, above, or below predetermined limits.

Pulse output is via a GR connector. Regulated voltage and regulated current are available via a 4-pin Bendix connector.

The Type R293 includes slide-out tracks for mounting in a standard 19 in rack, and requires only 3½ in of panel height.

PULSE OUTPUT

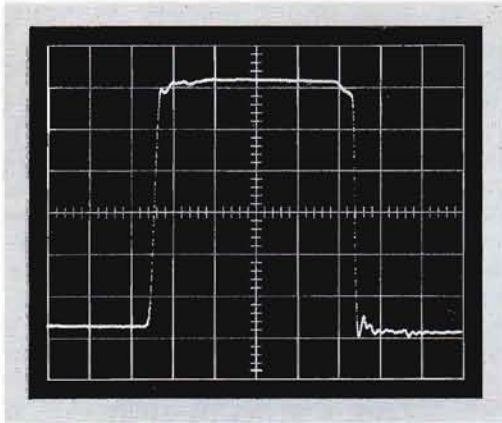

+12-volt pulse, 5 ns/cm.

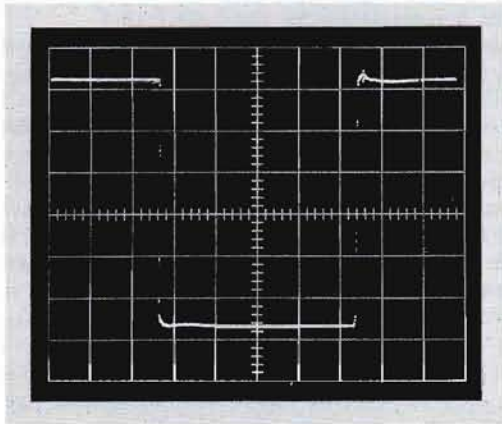

-12-volt pulse, 50 ns/cm.

PULSE CHARACTERISTICS INTO 50 Ω

CHARACTERISTIC	PERFORMANCE OR OPERATING RANGE	ACCURACY
RISETIME	≤1 ns at maximum amplitude	
FALLTIME	≤1 ns at ≥20-ns width, ≤2 ns at 2 to 20 ns width, at maximum amplitude	
*REPETITION RATE	≤10 kHz (ccw) to 90-100 kHz (cw), continuously variable, uncalibrated	±10% of programmed value
*WIDTH	≤2 ns to ≥250 ns, continuously variable, uncalibrated	±3% of programmed value plus 3 ns; ≤100 ps width jitter
*AMPLITUDE	6 V min to 12 V max, continuously variable, uncalibrated	±5%; or ±3% of programmed value
POLARITY	Positive or negative	
ABERRATIONS	Leading edge (first 10 ns): overshoot ≤3%; rounding ≤5%; ringing ≤3%. (After first 10 ns and before last 15 ns): droop ≤1%; flat-top ≤2%. Trailing edge (last 15 ns): overshoot ≤5%; rounding ≤5%; ringing ≤10%; storage ≤5%.	

POWER SUPPLY

REGULATED CURRENT SUPPLY

300 μA to 300 mA (continuously variable) at up to 20 V, positive or negative polarity. Accuracy* within ± (3% of dial reading) +50 μA, or ± (3% of programmed value) +50 μA. ±1% maximum change with line change from 93.5 V to 135 V. Ripple ≤0.5% or 50 μA, whichever is greater. Overshoot ≤0.5% of change in programmed current.

REGULATED VOLTAGE SUPPLY

0 to ±50 V (continuously variable) at up to 200 mA. Accuracy* within ± (2% of dial reading) +25 mV, or ± (3% of programmed value) +25 mV. ±1% maximum change with line change from 93.5 V to 135 V. Ripple ≤0.05% or 5 mV, whichever is greater. Overshoot ≤5% of change in programmed voltage.

OTHER CHARACTERISTICS

PRETRIGGER PULSE

≥ + 1/2 V into 50 Ω and ≥ + 2 V into open circuit, occurs approximately 200 ns before leading edge of main pulse. 100-ps maximum jitter between pretrigger and leading edge of main pulse.

EXTERNAL TRIGGER REQUIREMENT

≥2-V; DC to 100 kHz; ≤1-μs risetime; 200 V DC maximum.

POWER REQUIREMENTS

93.5 V to 135 V or 187 V to 270 V, low or high range selected by rear panel switch. 50 to 400 Hz, 65 watts maximum.

DIMENSIONS AND WEIGHTS

Height	3 1/2 in	8.9 cm
Width	19 in	48.3 cm
Depth	16 5/8 in	42.2 cm
Net weight	20 3/4 lb	9.4 kg
Domestic shipping weight	≈55 lb	≈25.0 kg
Export-packed weight	≈86 lb	≈39.1 kg

INCLUDED STANDARD ACCESSORIES

5-ns GR cable (017-0502-00); 4-pin power-supply output connector (131-0268-00); 24-pin remote-program connector (131-0325-00); set mounting tracks (351-0084-00); 3-conductor power cord (161-0010-03); 3 to 2-wire adapter (103-0013-00); two instruction manuals (070-0433-00); one set mounting hardware.

TYPE R293 PROGRAMMABLE PULSE GENERATOR AND POWER SUPPLY

Please refer to Terms and Shipment, General Information Page

*Programmable parameters. Stated program accuracy is with 1% program resistor.

Limited-Demand Instruments

The instruments described on this page are in limited demand, but represent a desirable choice in a few specialized cases. As such, they are available for you who have a need for them. Consult your Tektronix Field Engineer for information on other instruments in the Tektronix product line that generally give greater value in application areas presently filled by these instruments.

TYPE RM31A RACK-MOUNT OSCILLOSCOPE

The Type R422 Oscilloscope, described on page 34, is recommended as a replacement for the Type RM31A. Type R422 is not a plug-in type oscilloscope. If plug-in versatility is required, see Type RM543B, described on page 92.

The Tektronix Type RM31A is a rack-mount oscilloscope with bandwidth from DC to 15 MHz (3-dB down) and a single time-base system with calibrated sweep rates from 0.1 $\mu\text{s}/\text{cm}$ to 5 s/cm and with X5 sweep magnifier. The instrument uses a broad selection of Tektronix letter-series and 1-series plug-in units to adapt the vertical deflection system to various application areas. The Type RM31A fits in a standard 19-in rack and requires approx 14 in of panel height.

TYPE 555 OSCILLOSCOPE

The Type 556 Oscilloscope, described on page 116, is recommended as a replacement for the Type 555 Oscilloscope.

The Type 555 Oscilloscope is a dual-beam laboratory instrument for accurate measurements in the DC to 33 MHz range, (3-dB down). Two complete horizontal-deflection systems and two independent vertical amplifiers provide for completely independent deflection of the two beams.

Either of two plug-in time base units can control the sweep, over a range of 0.1 $\mu\text{s}/\text{cm}$ to 5 s/cm, of either or both electron beams. In addition, a continuously-variable calibrated sweep delay allows expansion of a selected portion of the undelayed sweep for precise time measurements. Delayed and undelayed sweeps can be presented simultaneously.

The wide-band main amplifiers in the Type 555 are designed to accept Letter-Series and 1-Series Plug-In Units for a high degree of signal-handling versatility.

TYPE CA PLUG-IN UNIT

The Type 1A2 Plug-In Unit, described on page 133, is recommended as a replacement for Type CA.

The Tektronix Type CA Plug-In Unit contains two identical input channels. Either channel can be operated separately. The two channels can be electronically switched, either at a chopped rate of about 100 kHz, or triggered by the oscilloscope sweep. In addition, both channels can be combined at the output, adding or subtracting according to the settings of the polarity switches. Bandwidth is DC to 24 MHz when used with current-production Type 540-Series, Type 555, 556, and (with Type 81A Adapter) 580 Series Oscilloscopes.

TYPE D DIFFERENTIAL PLUG-IN UNIT

The Type 1A6 Plug-In Unit, described on page 138, is recommended as a replacement for the Type D Plug-In Unit.

The Tektronix Type D Plug-In Unit equips Type 530, 540, 550 and 580 (with Type 81A Adapter) Series Oscilloscopes for work requiring DC-coupling at a deflection factor of 1 mV/cm. Differential input with high rejection ratio for in-phase signals permits cancellation of unwanted or interfering signals. Bandwidth is DC to 300 kHz (3-dB down) at 1 mV/cm, increasing to 2 MHz at 50 mV/cm. Common-mode rejection ratio is 10,000:1 for in-phase signals up to 20 kHz at all positions of the mV/cm multiplier switch.

TYPE E PLUG-IN UNIT

The Type 1A7A Plug-In Unit, described on page 139, is recommended as a replacement for the Type E Unit.

The Tektronix Type E Plug-In Unit provides Tektronix Type 530, 540, 550 and 580 (with Type 81A Adapter) Series Oscilloscopes with a calibrated deflection factor of 50 $\mu\text{V}/\text{cm}$ for low-level applications. Separate high-frequency and low-frequency response controls permit restricting the bandwidth to increase the signal-to-noise ratio, from minimum bandwidth of 0.06 Hz to maximum bandwidth of 60 kHz. Common-mode rejection up to 50,000 to 1 is possible for in-phase signals up to 1 kHz with amplitudes up to $\pm 2\text{ V P to P}$. Combined noise and hum is 5 μV RMS with grounded inputs.

TYPE M PLUG-IN UNIT

The Type 1A4 Plug-In Unit, described on page 134, is recommended as a replacement for the Type M Unit.

The Type M Unit provides four-trace displays in Type 530, 540, 550 and 580 (with Type 81A Adapter) Series Oscilloscopes. The four input channels are identical. Each has separate controls for coupling, attenuating, inverting and positioning the signal. Chopped (successive 1- μs , approx, segments displayed) or alternate electronic switching can be used for multi-channel displays. Bandwidth is DC to 20 MHz with current production Type 540-Series, 556, 581A, 585A Oscilloscopes.

TYPE Z PLUG-IN UNIT

The Type W Differential-Comparator Plug-In Unit, described on page 129, is an excellent replacement for the Type Z.

The Type Z Plug-In Unit is designed for use with Tektronix Type 530, 540, 550 and (with Type 81A Adapter) 580 Series Oscilloscopes. The unit operates as a conventional preamplifier, a differential preamplifier, and a calibrated differential comparator. Resolution to 0.005% can be attained. In the differential mode, accurate DC comparison voltages are added differentially to the input signal via the slide-back technique, providing a vertical scale up to $\pm 2,000\text{ cm}$.

Please refer to Terms and Shipment, General Information page.

Limited-Demand Instruments

The instruments described on this page are in limited demand, but represent a desirable choice in a few specialized cases. As such, they are available for you who have a need for them. Consult your Tektronix Field Engineer for information on other instruments in the Tektronix product line that generally give greater value in application areas presently filled by these instruments.

TYPE 507 OSCILLOSCOPE

The Tektronix Type 507 is a specialized oscilloscope, designed primarily for high-voltage surge testing of power transformers, high-voltage insulators, lightning arrestors, etc. Careful design of circuitry grounding points ensures minimum sensitivity to extraneous disturbances caused by large voltage transients often introduced into the grounding system.

TYPE RM544 MOD 720A OSCILLOSCOPE

The Tektronix Type RM544 MOD 720A Oscilloscope is designed for high-speed transient photography. A direct-access plug-in unit provides loop-through input for direct AC-coupling to the CRT vertical deflection plates, resulting in display risetime to 1 ns. The accelerating potential to the CRT is either 12 kV or 24 kV; 24-kV writing speed is up to 2000 cm/ μ s. Deflection factor at 24 kV is 12.7 V/div. 50- Ω feed-through system accepts Rossi input for time-reference modulation of horizontal sweep. Two connectors on the front panel facilitate camera power interconnections and provide for camera shutter closure at the end of a single sweep.

Optional 1-series plug-in units permit measuring capabilities from DC to 50 MHz at deflection factors to 5 mV/cm.

TYPE 283/R283 REAL-TIME ADAPTER

The Type 283 or R283 Real Time Adapter is an accessory to provide real-time sampling capability for Type 3T4 Programmable Sampling Sweep.

The adapter provides accurate sweep rates from 1 s/div through 1 ms/div in 10 calibrated steps. Triggering can be from either the Channel A or B vertical output signal (from vertical sampling unit) or an external source.

Manual control of REAL TIME/DIV, DISPLAY FUNCTIONS, and TRIGGERING SOURCE, MODE, and LEVEL can be from front-panel controls, or REAL TIME/DIV can be remotely controlled by a Type 262 or other closure-type programmer.

The R283 fits a 19-inch rack and requires 3½ inches of panel height.

TYPE 3A1 DUAL-TRACE AMPLIFIER

The Type 3A6 Plug-In Unit, described on page 172, has the same characteristics as the 3A1, and in addition, contains an internal delay line that allows viewing of the leading edge of the sweep-triggering waveform.

The Tektronix Type 3A1 is a general-purpose dual-trace plug-in unit having two separate channels, each with identical characteristics. The unit can operate in one of five modes for a variety of single and dual-trace displays. The instrument can be used in Tektronix Type 561A, 564 and 565 Oscilloscopes, and may also be used in the Type 567 or 568 Digital Readout Oscilloscopes when digital readout is not required. Linear scan is 8 cm. Bandwidth is DC to 10 MHz (3-dB down).

TYPE 292 SEMICONDUCTOR TESTER POWER SUPPLY

Type 292 provides DC power and sub-nanosecond environment for reading out time and charge data from semiconductor diodes and transistors, and is used between a sub-nanosecond pulse generator and the 50- Ω input of a sampling oscilloscope. Electronically-regulated TEST VOLTS (1, 2, 5, 10, 20 V) and BIAS CURRENT (11 calibrated steps from 0.1 mA to 200 mA) are connected to the test fixture in use. Polarity of either can be inverted from the front panel; both supplies are short-circuit and open-circuit protected. A transistor test fixture is shipped with each Type 292, and consists of an etched-circuit board with a transistor socket.

TYPE 1121 AMPLIFIER

The Tektronix Type 1121 Amplifier is a cascaded-input amplifier which increases the amplitude of low-level signals; thus increases the sensitivity of the oscilloscope or other associated instrument with which it is operated. Bandwidth is 5 Hz to 17 MHz (3-dB down). The output, terminated in 93- Ω coaxial cable, allows separation of at least 100 feet between the Type 1121 and associated instrument without causing noticeable deterioration of the response. Output voltage of ± 1 volt guarantees linear amplification of any signal up to ± 10 mV at full gain. Rise time is approx. 21 ns with the input attenuator control in the 1X, 2X, 5X or 10X positions. Attenuation up to 500X is provided.

Please refer to Terms and Shipment, General Information page.

CHOOSING A CAMERA

Tektronix Cameras, component parts, and accessories meet a wide variety of trace-recording needs. Factors to consider in choosing the most appropriate camera include the ability to up-grade or add to your present camera, type of viewing, compatibility with different oscilloscopes, writing speed, type and size of print desired. Each of these factors are discussed below.

CAMERA FLEXIBILITY

C-12 and C-27 Cameras are designed for maximum flexibility and easy interchange of components. Five interchangeable lenses are available, providing a wide range of object-to-image ratios and maximum apertures. Lens mounts are pre-focused, for easy interchange. Four interchangeable backs are available: Polaroid¹ Land Pack Film or Roll Film, and Graflok² 4x5 or 2 1/4 x 3 1/4.

The C-40 Camera is equipped with our fastest lens and Polaroid Roll-Film back. Any of the other optional lenses and/or backs are also useable with the Type C-40, if desired.

The C-30 Camera is of integrated design, with a variable object-to-image ratio and permanently attached Polaroid Pack Film back. It is the smallest and most portable camera.

All cameras can be operated electrically with the shutter actuator attachment. A projected graticule attachment is also available for the C-12 Camera.

VIEWING

The C-12 provides the most convenient viewing. Through use of a beam splitting mirror, an apparent direct-view of the CRT is obtained, thus eliminating parallax. The viewing tunnel provides comfortable binocular viewing (with or without glasses), and effectively shuts out ambient light.

The C-27 also features comfortable binocular viewing. The viewing tunnel, however, can be removed for stacking of 7-in rack model oscilloscopes. The viewer looks directly down the viewing tunnel at the CRT; a beam-splitting mirror is not used, as in the C-12.

C-30 and C-40 Cameras both swing open from left or right for viewing.

COMPATIBILITY

Camera adapters allow use of the C-12, C-27, C-30 and C-40 on many Tektronix Oscilloscopes. See page 292 for adapter part numbers and recommended camera/oscilloscope combinations. Some combinations are not recommended (for a number of reasons) even though adapters are available. The C-12, C-30, or C-40, for example, would probably not be used with a Type 502A Oscilloscope, since it is not possible to record a 10-cm vertical scan with these cameras.

PICTURE SIZE

With either Polaroid Land or conventional films, the exposable area of the film must be at least as large as the image from the lens. Image size will depend on the object-to-image ratio of the camera lens and on the size of the oscilloscope display. For example, the Graflok Back with 120 or 620 roll film would probably not be used with a 1:0.85 lens and a 10-cm wide oscilloscope display. This is because the image of the display is 8.5 cm wide and the exposable area (long dimension) of the film is only 7.8 cm maximum (it can be as short as 5.7 cm, depending on film format). The film size should be at least 5 mm larger than the size of the image to allow for normal tolerances in the construction of the Camera Backs and for the position of the film in the back.

¹Registered Trade-Mark Polaroid Corporation

²Registered Trade-Mark Graflex, Inc.

FILM TYPES

Polaroid Type 47 and Type 107 (roll film and pack film, respectively) each have an ASA equivalent exposure index of 3000. Polaroid Type 410 roll film is especially suited for high-speed photography. It has an ASA equivalent of 10,000. Each film type has 8 exposures, and develops in 10 seconds. Roll-film develops inside the film back; pack film develops outside.

Polaroid films can also be used in a Polaroid 4x5 film holder with the 4x5 Graflok Back. This combination, used with Type 57 film (3000 speed), a 1:1 lens, and a C-27 Main Frame will give full-size records of graticule areas as large as 8x10 cm. A Standard C-27 Camera (1:0.85 lens) equipped in the same way will make a complete record of a 10x10-cm graticule.

If you want to obtain a negative from which a number of prints can be made, either Type 55 P/N film (which comes in Polaroid Land 4x5, only) or conventional film is satisfactory.

Conventional cut film and 120 roll film can be used with either the 4x5 or 2 1/4 x 3 1/4 Graflok Back and the proper holder or adapter. A number of film types, manufactured by Eastman Kodak, Agfa, Ansco, and others, are available in both forms, at ASA speeds from 64 to 1250.

A detailed list of film types and characteristics of these and other films not mentioned here can be obtained from the respective manufacturer.

WRITING SPEED

Writing speed is an indication of the relative light-gathering ability of the various lenses or camera systems. Factors within the Camera that affect writing speed include the lens (an arbitrary writing speed index is assigned to each lens), light loss (the special beam splitting mirror in the C-12 transmits approximately 65% of the available light to the film), and film type.

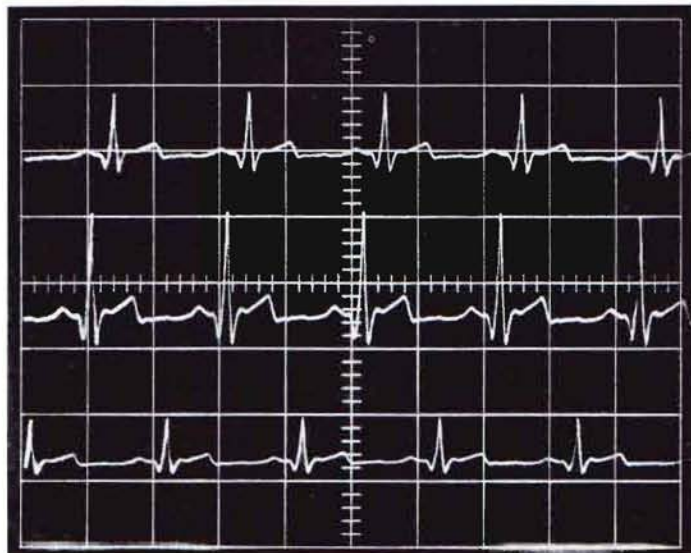

USED IN STANDARD C-12 AND C-27 CAMERAS

GENERAL PURPOSE— $f/1.9$, 1:0.85 object-to-image ratio . . . image brightness sufficient for most applications. When photographing 8x10 cm graticules, or 10x10 division graticules such as used on Tektronix Types 575 and 536, provides the largest size image that will still fall within the maximum recording area of 3 1/4 x 4 1/4 size Polaroid film.

CHOOSING A CAMERA

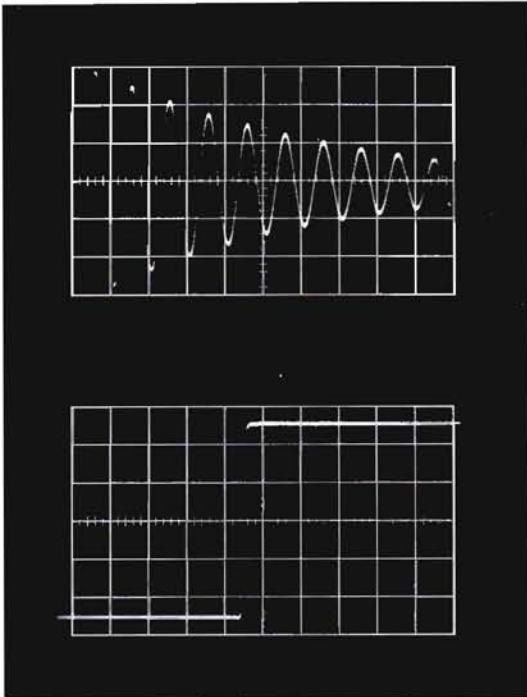

Photographs taken under identical conditions illustrate relative writing-speed capabilities of the $f/1.9$ and $f/1.3$ lenses.

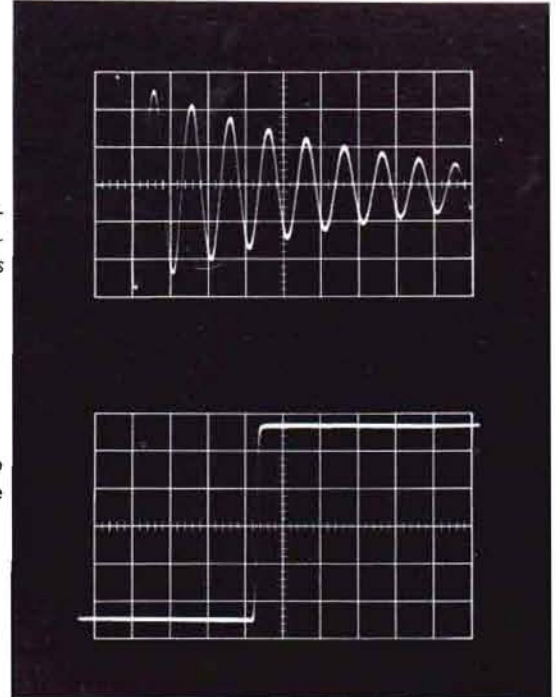

Photographs on these two pages reproduced in the actual size of the print.

HIGH WRITING SPEED— $f/1.9$, 1:0.5 object-to-image ratio . . . for high writing speed applications such as single-shot photography of fast transients, writing speed 1.5X general-purpose lens.

USED IN STANDARD C-40 CAMERA

ULTRA-HIGH WRITING SPEED— $f/1.3$, 1:0.5 object-to-image ratio . . . for applications where writing speed is the prime consideration . . . advances the state of the art and in combination with the C-27 Main Frame records higher-speed phenomena than before, writing speed 3X general-purpose lens.

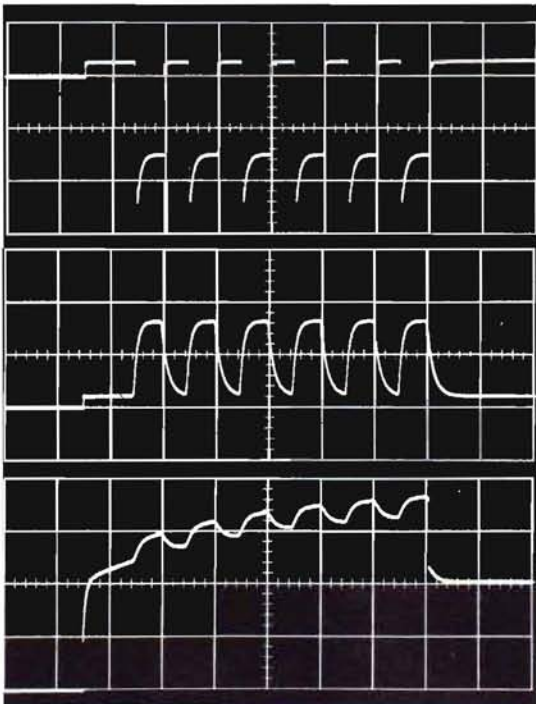

FILM ECONOMY & MEDIUM WRITING SPEED— $f/1.9$, 1:0.7 object-to-image ratio . . . efficient use of film, writing speed 1.25X general-purpose lens.

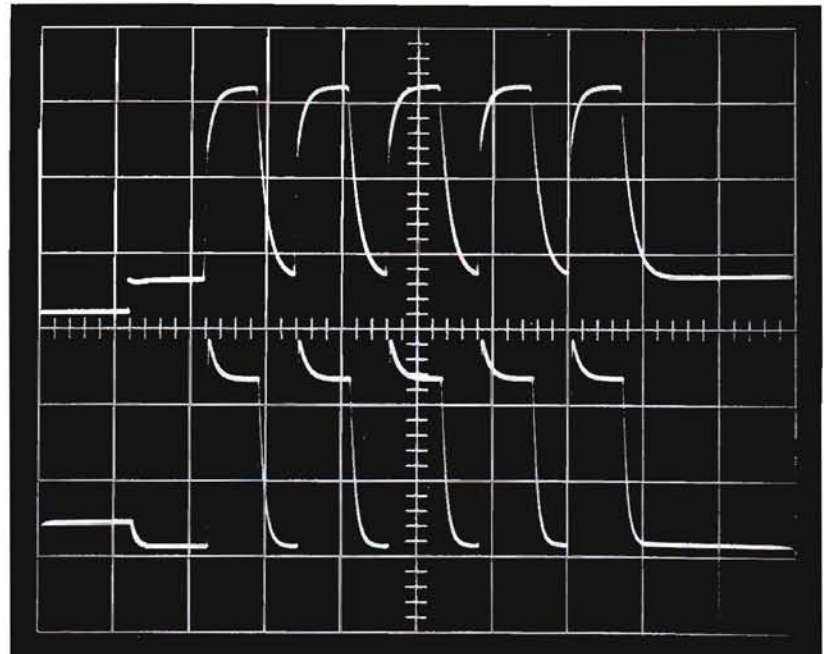

PRECISE FULL-SIZE IMAGE & HIGH WRITING SPEED— $f/1.4$, 1:1 object-to-image ratio . . . for precise full-size records . . . measurements can be scaled directly off photograph with maximum resolution, writing speed 1.75X general-purpose lens.

C-12

TRACE-RECORDING CAMERAS

- **NO-PARALLAX BINOCULAR VIEWING**
- **LIFT-ON MOUNTING, SWING-AWAY HINGING**
- **EASILY-ACCESSIBLE CONTROLS**
- **ROTATING & SLIDING BACK**
- **LENS & BACK OPTIONS**
- **ACCEPTS PROJECTED GRATICULE ACCESSORY**

The C-12 is a general-purpose trace-recording camera suitable for use with most Tektronix full-size oscilloscopes. The special beam-splitting mirror in the C-12 (and another conventional mirror) reflects a portion of the image up through the viewing tunnel, giving the viewer the impression of a straight-on view of the CRT. This no-parallax binocular viewing is especially desirable when the oscilloscope has an external graticule. The beam-splitting mirror also allows use of the Projected Graticule accessory (described on page 291).

The beam-splitting mirror transmits approximately 65% of available light to the film. For this reason, we recommend an optional lens and/or roll-film back if applications include single-shot photographs at the fastest sweep rates.

STANDARD C-12

LENS

75-mm f/1.9 oscilloscope recording lens, stops down to f/16.

SHUTTER SPEEDS

1 to 1/50 second plus Bulb and Time.

OBJECT-TO-IMAGE RATIO

1:0.85, records 8 x 10-cm graticule on 3 1/4 x 4 1/4 Polaroid film.

FILM BACK

Polaroid Pack Film back accepts 3000-speed film which develops outside camera in about 10 seconds.

MECHANICAL

Lift-on mounting and swing-away hinging with C-12 Camera Adapter (not included, see page 292). Accepts Tektronix Shutter Actuator and Projected Graticule.

DIMENSIONS AND WEIGHTS

Height	15 3/8 in	39.0 cm
Width	7 1/2 in	19.0 cm
Depth	17 1/4 in	43.8 cm
Net weight	12 1/4 lb	5.6 kg
Domestic shipping weight	≈16 lb	≈7.3 kg
Export-packed weight	≈33 lb	≈15.0 kg

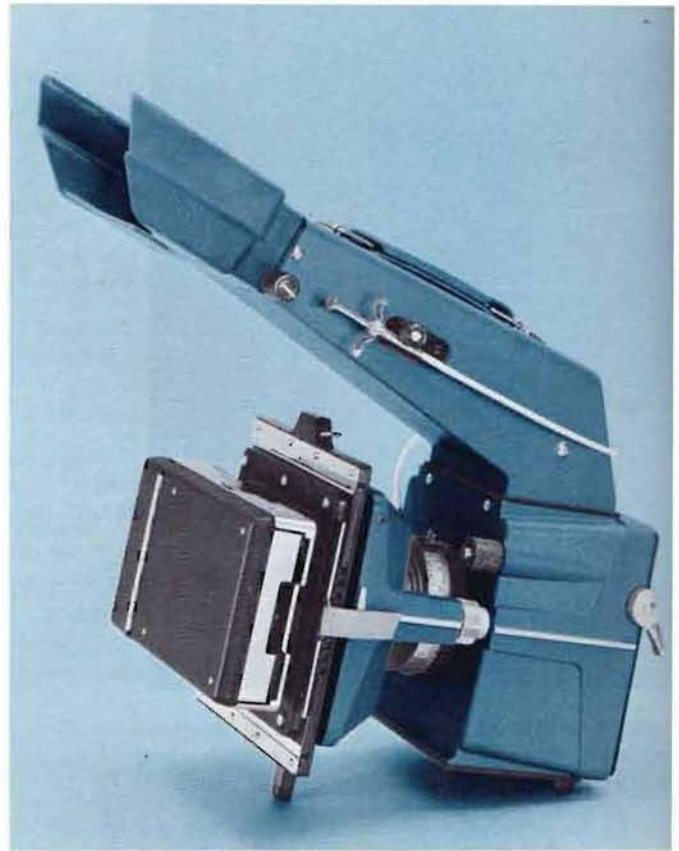

INCLUDED STANDARD ACCESSORIES

Cable release (122-0586-01), focus plate (387-0893-00), two instruction manuals (070-0383-01).

ROLL-FILM CAMERA identical to the Standard C-12, except a Polaroid Roll-Film Back is substituted for the Pack-Film Back.

C-12-R CAMERA

ELECTRICALLY-ACTUATED CAMERA identical to the Standard C-12, but with a shutter actuator and built-in power supply. (See page 290.)

C-12-S CAMERA, for 115-V operation

C-12-SB CAMERA, for 230-V operation

ELECTRICALLY-ACTUATED CAMERA with Roll-Film Back combines features of the C-12-R and C-12-S, above.

C-12-RS CAMERA, for 115-V operation

C-12 RSB CAMERA, for 230-V operation

All cameras are sold without mounting adapter; order from page 292.

OPTIONAL ACCESSORIES

PROJECTED GRATICULE for 115 volts, order 016-0204-00

PROJECTED GRATICULE for 230 volts, order 016-0234-00

CARRYING CASE, order 016-0208-01

Please refer to Terms and Shipment, General Information page.



SWING-AWAY HINGING



INTERCHANGEABLE BACKS

CUSTOM C-12 CAMERAS				
LENS (Writing speed compared to Standard f/1.9, 1:0.85 lens)	SHUTTER ACTUATOR and BUILT-IN POWER SUPPLY*	POLAROID FILM BACK	ORDER NUMBER	
FILM ECONOMY & MEDIUM WRITING SPEED — f/1.9, 1:0.7. Records two 6 x 10-cm or three 4 x 10- cm graticules on each film. Writing speed 1.25X Standard Lens.	No	Pack Film Roll Film	C-12-547 C-12-547 R	
	Yes	Pack Film Roll Film	C-12-547 S C-12-547 RS	
HIGH WRITING SPEED —f/1.9, 1:0.5 Records fast-writing displays such as single-shot transients. Writing speed 1.5X Standard Lens.	No	Pack Film Roll Film	C-12-549 C-12-549 R	
	Yes	Pack Film Roll Film	C-12-549 S C-12-549 RS	
PRECISE FULL-SIZE IMAGE & HIGH WRITING SPEED —f/1.4, 1:1. Records full-size image of 8 x 10- cm graticule (on 4 x 5 film with optional Graflok Back). Writing speed 1.75X Standard Lens.	No	Pack Film Roll Film	C-12-608 C-12-608 R	
	Yes	Pack Film Roll Film	C-12-608 S C-12-608 RS	
ULTRA-HIGH WRITING SPEED —f/1.3, 1:0.5 Where writing speed is prime consideration. Re- cords two 6 x 10-cm graticules on each film. Writ- ing speed 3X Standard Lens.	No	Pack Film Roll Film	C-12-662 C-12-662 R	
	Yes	Pack Film Roll Film	C-12-662 S C-12-662 RS	

Any C-12 Standard or Custom Trace-Recording Camera can be ordered less back. Use suffix 'G' after the Order Number. 4 x 5 and 2 1/4 x 3 1/4 Graflok Backs and accessories are shown on page 293.

*Power supplies are normally wired for 115 V. For 230 V add suffix 'B' to the Order Number. Price for either is the same.

All cameras are sold without mounting adapter; order from page 292.

Please refer to Terms and Shipment, General Information page.

C-27

TRACE-RECORDING CAMERAS

- COMFORTABLE BINOCULAR VIEWING
- LIFT-ON MOUNTING, SWING-AWAY HINGING
- EASILY-ACCESSIBLE CONTROLS
- ROTATING & SLIDING BACK
- LENS & BACK OPTIONS

The C-27 is a general-purpose trace-recording camera suitable for use with most Tektronix full-size oscilloscopes. The viewer sees the CRT without the use of mirrors. As a result the maximum amount of light is transferred to the film. The viewing tunnel can be easily removed, and the carrying handle folded out of the way. This allows camera mounting on two 7-inch rack-model oscilloscopes placed one over the other. In addition the camera frame can be rotated 90° or 180°, thus positioning the viewing tunnel at either side or at the bottom of the camera. The opening at the camera front allows the complete photographic coverage of large graticules such as the Type 502A Oscilloscope.

STANDARD C-27

LENS

75-mm f/1.9 oscilloscope recording lens, stops down to f/16.

SHUTTER SPEEDS

1 to 1/50 second plus Bulb and Time.

OBJECT-TO-IMAGE RATIO

1:0.85, records 8 x 10-cm graticule on 3 1/4 x 4 1/4 Polaroid film, 10 x 10-cm graticule with optional Graflok back and 4 x 5 film.

FILM BACK

Polaroid Pack Film back accepts 3000-speed film which develops outside camera in about 10 seconds.

MECHANICAL

Lift-on mounting and swing-away hinging with C-27 Camera Adapter (not included, see page 292). Accepts Tektronix Shutter Actuator.

DIMENSIONS AND WEIGHTS

Height with viewing tunnel	17 ³ / ₁₆ in	43.7 cm
Height without viewing tunnel	8 in	20.3 cm
Width	7 ¹ / ₂ in	19.0 cm
Depth with viewing tunnel	13 ³ / ₈ in	33.9 cm
Depth without viewing tunnel	12 in	30.5 cm
Net weight	10 ¹ / ₂ lb	4.8 kg
Domestic shipping weight	≈ 14 lb	≈ 6.4 kg
Export-packed weight	≈ 36 lb	≈ 16.4 kg

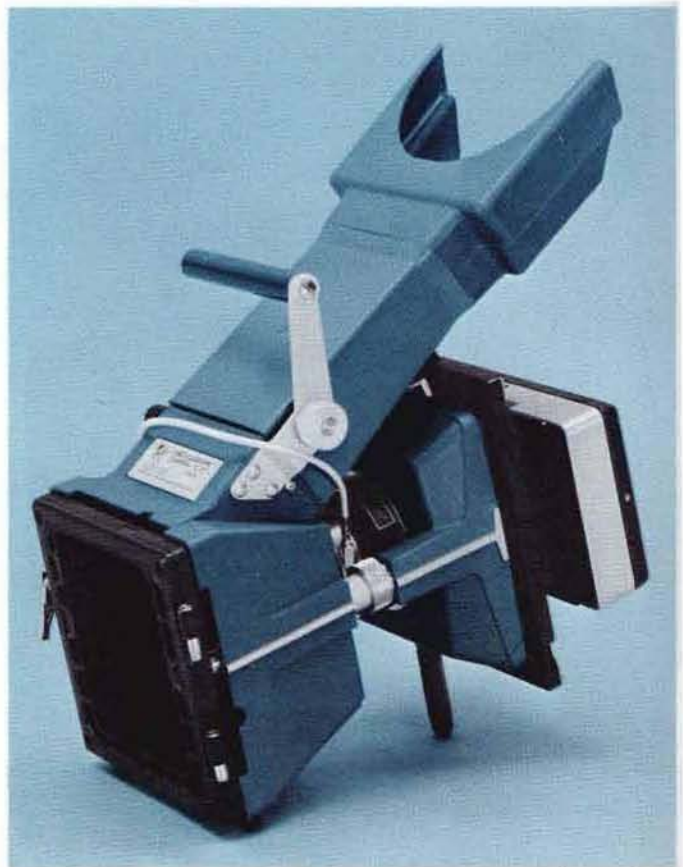

INCLUDED STANDARD ACCESSORIES

Cable release (122-0586-01), focus plate (387-0893-00), two instruction manuals (070-0383-01).

ROLL-FILM CAMERA identical to the Standard C-27, except a Polaroid Roll-Film Back is substituted for the Pack-Film Back.

ELECTRICALLY-ACTUATED CAMERA identical to the Standard C-27, but with a shutter actuator and built-in power supply. (See page 290.)

C-27-S CAMERA, for 115-V operation

C-27-SB CAMERA, for 230-V operation

ELECTRICALLY-ACTUATED CAMERA with Roll-Film Back combines features of the C-27-R and C-27-S, above.

C-27-RS CAMERA, for 115-V operation

C-27-RSB CAMERA, for 230-V operation

All cameras are sold without mounting adapter; order from page 292.

OPTIONAL ACCESSORY

CARRYING CASE, order 016-0208-01

Please refer to Terms and Shipment, General Information page.

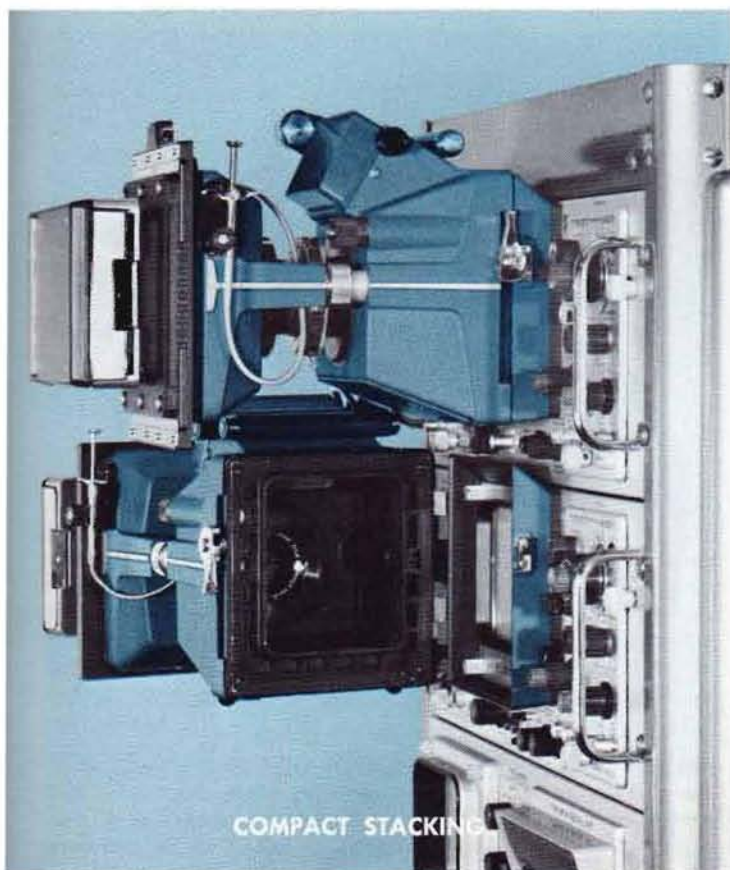

COMPACT STACKING

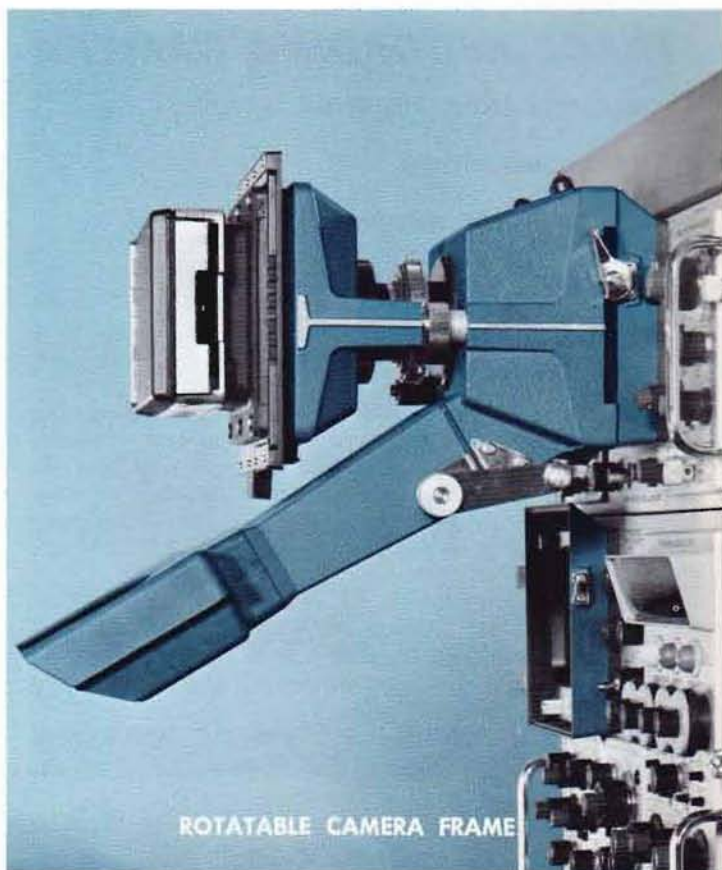

ROTATABLE CAMERA FRAME

CUSTOM C-27 CAMERAS				
LENS (Writing speed compared to Standard f/1.9, 1:0.85 lens)	SHUTTER ACTUATOR and BUILT-IN POWER SUPPLY*	POLAROID FILM BACK	ORDER NUMBER	
FILM ECONOMY & MEDIUM WRITING SPEED— f/1.9, 1:0.7. Records two 6 x 10-cm, three 4 x 10-cm or one 10 x 10 cm graticule on 3 1/4 x 4 1/4 film. Writing speed 1.25X Standard Lens.	No	Pack Film Roll Film	C-27-547 C-27-547 R	
	Yes	Pack Film Roll Film	C-27-547 S C-27-547 RS	
HIGH WRITING SPEED—f/1.9, 1:0.5 Records fast-writing displays such as single-shot trans- ients. Writing speed 1.5X Standard Lens.	No	Pack Film Roll Film	C-27-549 C-27-549 R	
	Yes	Pack Film Roll Film	C-27-549 S C-27-549 RS	
PRECISE FULL-SIZE IMAGE & HIGH WRITING SPEED —f/1.4, 1:1. Records full-size image of 10 x 10-cm gra- ticule (on 4 x 5 film with optional Graflok Back). Writing speed 1.75X Standard Lens.	No	Pack Film Roll Film	C-27-608 C-27-608 R	
	Yes	Pack Film Roll Film	C-27-608 S C-27-608 RS	
ULTRA-HIGH WRITING SPEED—f/1.3, 1:0.5 Records two 6 x 10-cm graticules on each film. Writ- ing speed 3X Standard Lens.	No	Pack Film Roll Film	C-27-662 C-27-662 R	
	Yes	Pack Film Roll Film	C-27-662 S C-27-662 RS	

Any C-27 Standard or Custom Trace-Recording Camera can be ordered less back. Use suffix 'G' after the Order Number. 4 x 5 and 2 1/4 x 3 1/4 Graflok Backs and accessories are shown on page 293.

*Power supplies are normally wired for 115 V. For 230 V add suffix 'B' to the Order Number. Price for either is the same.

All cameras are sold without mounting adapter; order from page 292.

C-30

TRACE-RECORDING CAMERA

- COMPACT, LIGHT WEIGHT
- LIFT-ON MOUNTING
- LEFT OR RIGHT HINGING
- EASILY-ACCESSIBLE CONTROLS
- VARIABLE MAGNIFICATION

The C-30 is a compact, light weight trace-recording camera designed for use with Tektronix portable instruments. It mounts directly to Type 422, 453, and 454 Oscilloscopes and Type 491 Spectrum Analyzer. Camera adapters are available for other portable and full-size oscilloscopes. The camera swings open from the left or right, as desired, and can be quickly lifted off the oscilloscope when not needed.

The C-30 is an ideal camera for use with the Type 422 Oscilloscope and Type 491 Spectrum Analyzer. It can also be used for general-purpose trace recording with Type 453 and 454 Oscilloscopes; the C-40 is recommended for single-shot photography at the fastest sweep rates.

Magnification is adjustable from 1:1.5 to 1:0.7. Writing speed at 1:0.7 is equal to the Standard C-27 Camera.

STANDARD C-30

LENS

56-mm f/1.9 oscilloscope recording lens, stops down to f/16.

SHUTTER SPEEDS

1 to 1/50 second plus Bulb and Time.

MAGNIFICATION

Variable in indexed steps of 1.5, 1.4, 1.3, 1.2, 1.1, 1.0, 0.9, 0.85, 0.8 and 0.7. At 0.7 magnification, an 8x10-cm or 10x10-div graticule (as in Type 536 and 575) can be recorded in its entirety.

FILM BACK

Polaroid Pack Film back accepts 3000-speed film which develops outside camera in about 10 seconds.

MECHANICAL

Lift-on mounting and swing-away hinging from left or right side. Mounts directly to Type 422, 453 and 454 Oscilloscopes and Type 491 Spectrum Analyzer. Camera adapters (not included, see below) allow use with other Tektronix Oscilloscopes. Rear casting recessed for carrying. Accepts Tektronix Shutter Actuator.

DIMENSIONS AND WEIGHTS

Height	4 ⁵ / ₈ in	11.7 cm
Width	7 ¹ / ₂ in	19.0 cm
Depth	9 ¹³ / ₁₆ in	24.9 cm
Net weight	4 ³ / ₄ lb	2.2 kg
Domestic shipping weight	≈ 9 lb	≈ 4.1 kg
Export-packed weight	≈ 14 lb	≈ 6.4 kg

INCLUDED STANDARD ACCESSORIES

Light seal for Type 422 and 491 (354-0279-00); light seal for Type 453 and 454 (354-0280-00); focus plate (387-0893-00); two instruction manuals (070-0527-00).

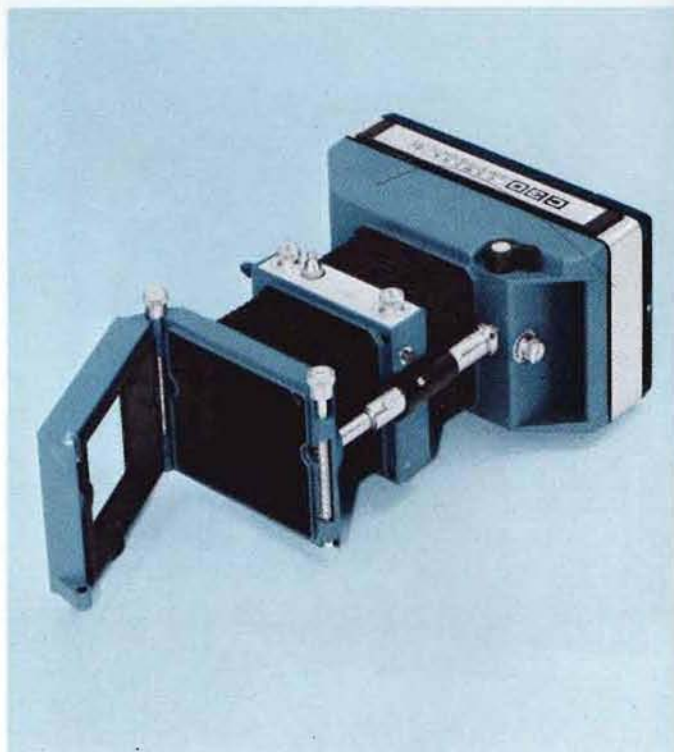

OPTIONAL CAMERA ADAPTERS

FOR OSCILLOSCOPE TYPE	PART NUMBER
310A, 317, 360	016-0241-00
321A	016-0242-00
Tektronix Oscilloscopes with 5-inch round CRT (except Type 519).	016-0243-00
Tektronix 560-Series with rectangular CRT, 529 and RM529.	016-0244-00
601	016-0248-00

OPTIONAL LENS

A portra lens will enable the Type C-30 Camera to photograph test setups. The depth of field when using the portra lens will vary with the f stop and magnification settings used. Generally, at f/1.9 there will be very little depth of field; while at f/16, the depth of field will allow quite a wide range of distance to be accommodated, depending upon the picture sharpness required. At a distance of 21 inches, a subject area 22 inches in diameter can be covered. Lens stores inside C-30 when not used; hardware included.

Order 016-0246-00

OPTIONAL CARRYING CASE

The C-30 carrying case holds the C-30 Camera, all standard accessories and extra film. The case is constructed of heavy-gauge, high-impact plastic, has foam-backed, vacuum-formed styrene liner. Dimensions are 6⁷/₈ x 11⁵/₁₆ x 14⁷/₁₆ inches. Net weight is 2³/₄ pounds; domestic shipping weight is ≈ 5 pounds. Order 016-0092-00

Please refer to Terms and Shipment, General Information page.

TRACE-RECORDING CAMERA

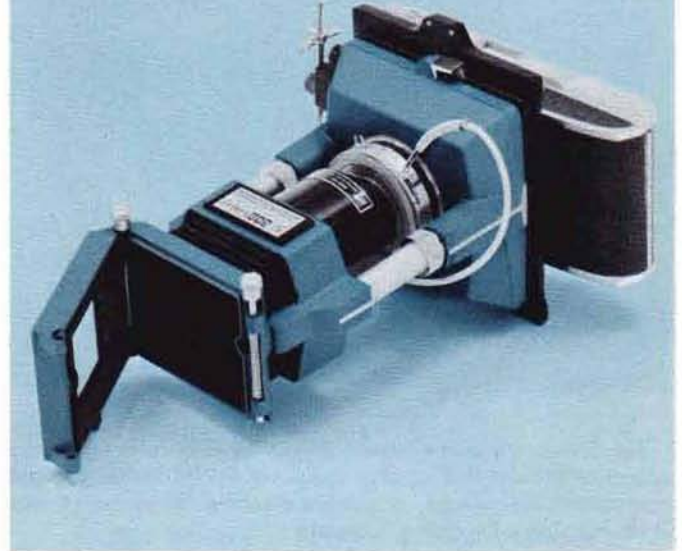

- **HIGH WRITING SPEED**
- **LIFT-ON MOUNTING**
- **LEFT OR RIGHT HINGING**
- **EASILY-ACCESSIBLE CONTROLS**
- **ROTATING AND SLIDING BACK**

The C-40 is a high-performance camera designed for Tektronix portable oscilloscopes. It provides the high-writing speed required when Type 453 and 454 Oscilloscopes are operated single-shot at the fastest sweep rates. It mounts directly to these oscilloscopes, and also to the Type 422 and 491. Camera adapters are available for other portable and full-size oscilloscopes. The camera swings open from the left or right, as desired, and can be quickly lifted off the oscilloscope when not needed.

The C-40 uses an f/1.3—1:0.5 lens and Polaroid 10,000-speed film. This combination provides the fastest writing speed available in a Tektronix Standard Camera, a gain of 2 to 3 times over that of the C-30.

STANDARD C-40

LENS

80-mm f/1.3 oscilloscope recording lens, stops down to f/16.

SHUTTER SPEEDS

1 to 1/50 second plus Bulb and Time.

OBJECT-TO-IMAGE RATIO

1:0.5, records up to three 6 x 10-div graticules (Type 453 and 454) or two 8 x 10-div graticules (Type 422 and 491) on 3 1/4 x 4 1/4 Polaroid film, using sliding back and multiple exposures.

FILM BACK

Polaroid Roll Film back accepts 10,000-speed film which develops inside camera in about 10 seconds.

MECHANICAL

Lift-on mounting and swing-away hinging from left or right side. Mounts directly to Type 422, 453 and 454 Oscilloscopes and Type 491 Spectrum Analyzer. Camera adapters (not included, see below) allow use with other Tektronix Oscilloscopes. Accepts Tektronix Shutter Actuator.

DIMENSIONS AND WEIGHTS

Height	6 3/4 in	17.1 cm
Width	9 3/4 in	24.7 cm
Depth	14 in	35.5 cm
Net weight	9 1/2 lb	4.3 kg
Domestic shipping weight	≈ 14 lb	≈ 6.4 kg
Export-packed weight	≈ 22 lb	≈ 10 kg

INCLUDED STANDARD ACCESSORIES

Light seal for Type 422 and 491 (354-0279-00); light seal for Type 453 and 454 (354-0280-00); focus plate (387-0460-00); cable release (122-0586-01); two instruction manuals (070-0616-00).

ELECTRICALLY-ACTUATED CAMERA

Same as above but with shutter actuator and built-in power supply. See next page for complete description.

For 115-V operation order C-40 S CAMERA

For 230-V operation order C-40 SB CAMERA

OPTIONAL CAMERA ADAPTERS

FOR OSCILLOSCOPE TYPE	PART NUMBER
310A, 317, 360	016-0241-00
321A	016-0242-00
Tektronix Oscilloscopes with 5-inch round CRT (except Type 519).	016-0243-00
Tektronix 560-Series with rectangular CRT, 529 and RM529.	016-0244-00

Please refer to Terms and Shipment, General Information page.

SHUTTER ACTUATOR

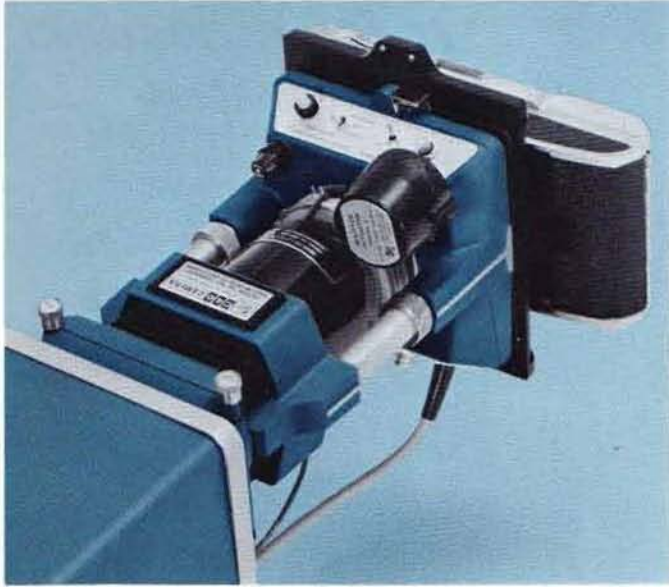

The Shutter Actuator System (Model 3) is a rotary solenoid-operated release that closely simulates the action of a hand-operated cable release. It permits electrical actuation of most Tektronix Trace-Recording Cameras.

A holding circuit in the power supply allows the actuator to be energized indefinitely without overheating. This feature is especially useful in obtaining Time exposures. Several actuators can be operated simultaneously by paralleling their REMOTE inputs and applying 24 VDC.

Two power supply packages are available. They are electrically identical, and differ only in mechanical configuration. One takes the place of the standard Rear Frame in the C-12, C-27, and C-40 Camera. The other is a separate small housing which can be mounted to either of the Polaroid Backs, or used remotely. Only the small power supply can be used with the C-30 Camera.

The actuator mounts to the cable release bushing of the C-30 Camera, or Alphax #3 and Ilex #3 shutters. It is not compatible with the Alphax #1 shutter.

Operating time from switch contact to full open blades at 115 VAC is 20 to 25 ms.

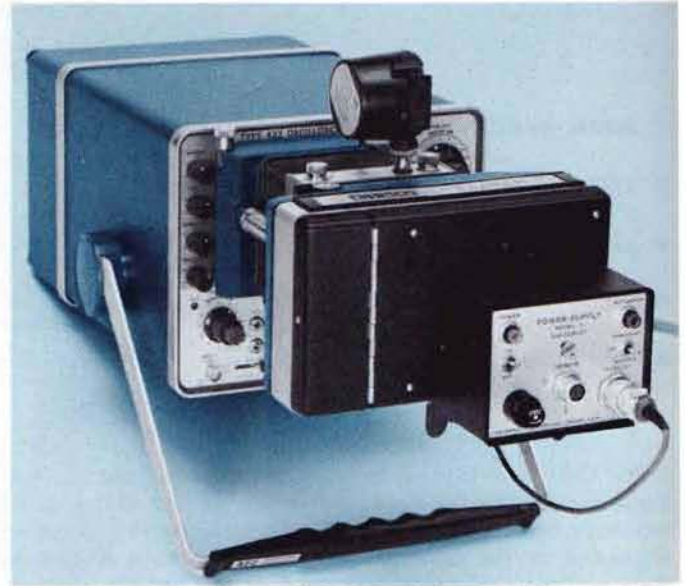

Power requirement is 115 VAC, 50 to 400 Hz, or 115 VDC.

Actuator for either supply (016-0218-01)

Separate Power Supply (016-0230-01)
Includes hinged mounting bracket (122-0713-00)

Built-in Power Supply (016-0231-01)

Power requirement is 230 VAC, 50 to 400 Hz, or 230 VDC.

Actuator for either supply (016-0235-01)

Separate Power Supply (016-0236-01)
Includes hinged mounting bracket (122-0713-00)

Built-in Power Supply (016-0237-01)

Please refer to Terms and Shipment, General Information page.

PROJECTED GRATICULE

The Projected Graticule for the C-12 Camera eliminates parallax and provides an area that can be used for write-in data.

Parallax is the apparent displacement of the trace in relation to the graticule. Error is introduced since the graticule and CRT phosphor are on different planes.

To eliminate parallax, a virtual image of the graticule is presented at the CRT phosphor plane, as viewed by the operator and as projected to the camera film plane.

Special graticules, reference waveforms, or any image that can be recorded on a film transparency, can be superimposed on the CRT display. The graticule is held in a slide assembly and is easily slipped in and out of the Projected Graticule case, making possible rapid change of graticules. The included slide assembly has a clear window. Assemblies can be obtained (see below) in several colors to match or contrast the projection with the CRT phosphor.

The projected graticule provides up to an 8 x 10-cm projection, a portion of which can be used for write-in data.

The light source is indexed in approx 1/2 f stop increments for use as a film exposure guide. This source can also be used for precise prefogging of film for increased sensitivity in fast writing-speed applications.

Operates on 90 to 130 V, or 180 to 260 V, 50 to 440 Hz.

Although the Projected Graticule case is small (it adds only 2 1/4 in to camera height), clearance problems exist with the Type 81A Adapter and a few plug-in unit/probe combinations. If in doubt about compatibility, please consult your Tektronix Field Office, Representative or Distributor.

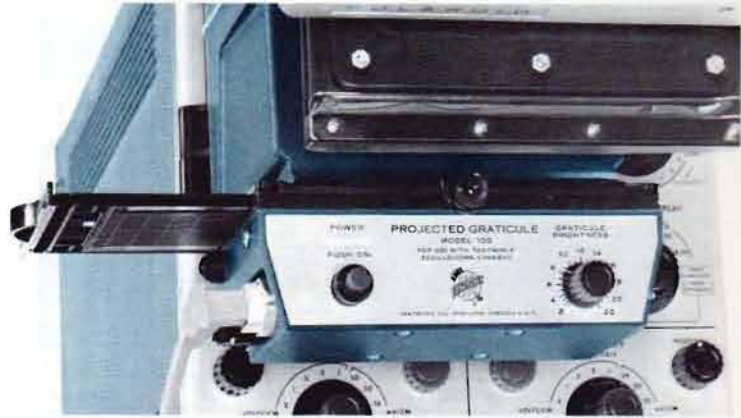

PROJECTED GRATITUDE for 115 volts (016-0204-00)

PROJECTED GRATITUDE for 230 volts (016-0234-00)

Includes: 1—power cord (161-0015-00); 1—3 to 2-wire adapter (103-0013-00); 1—graticule, 4 x 10 cm with write-in area and short minor lines (331-0117-00); 1—graticule, 6 x 10-cm with write-in area and short minor lines (331-0111-00); 1—graticule, 8 x 10 cm without write-in area, but with full minor lines (331-0119-00); 1—graticule mask, 4 x 10 cm (331-0118-00); 1—graticule mask, 6 x 10 cm (331-0116-00).

GRATICULE SLIDE ASSEMBLIES

Clear Window
122-0659-00

Blue Window
122-0667-00

Green Window
122-0668-00

Amber Window
122-0669-00

OPTIONAL GRATITUDES and MASKS

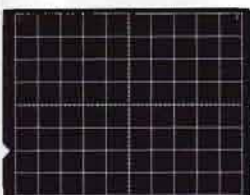

331-0126-00

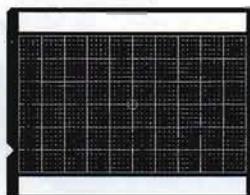

331-0123-00

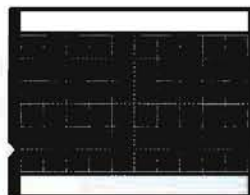

331-0137-00

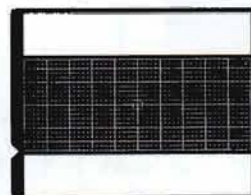

331-0122-00



6 x 10 cm
Mask
331-0116-00

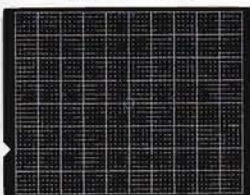

331-0119-00

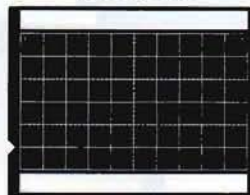

331-0131-00

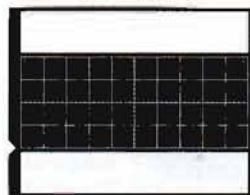

331-0117-00

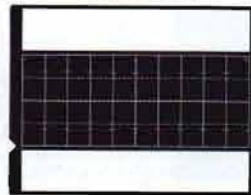

331-0136-00



4 x 10 cm
Mask
331-0118-00

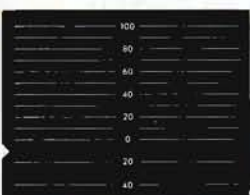

331-0130-00

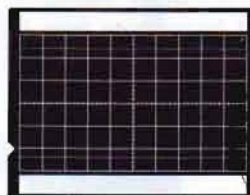

331-0124-00

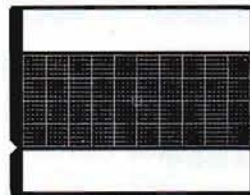

331-0120-00

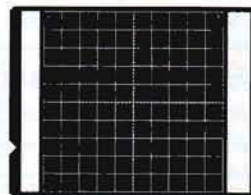

331-0127-00



10 x 10 div Mask
(for Type 570,
575, 536)
331-0129-00

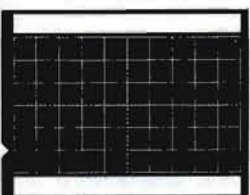

331-0111-00

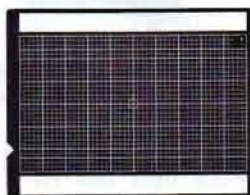

331-0125-00

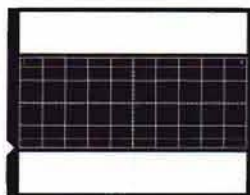

331-0121-00

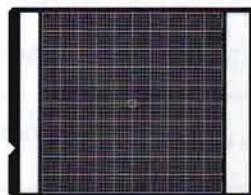

331-0128-00



331-0161-01

CAMERA COMPONENTS

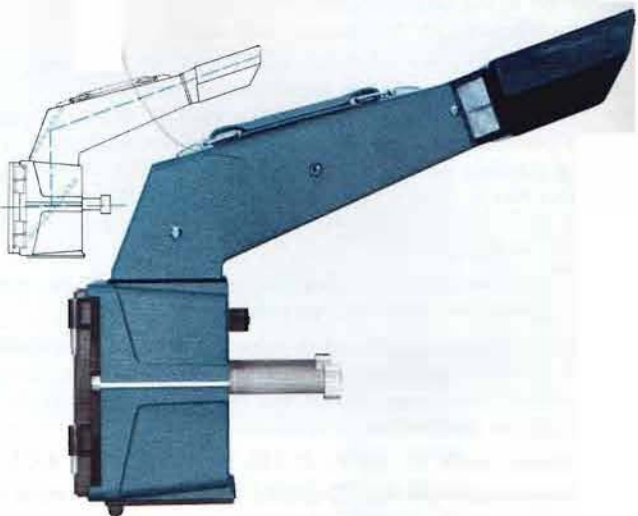
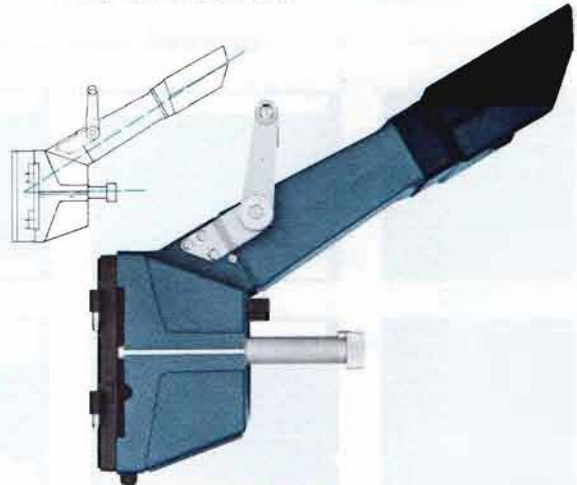
OSCILLOSCOPE/CAMERA ADAPTERS					MAIN FRAME ASSEMBLIES		
OSCILLOSCOPE TYPE	RECOMMENDED CAMERA	C-12 ADAPTER PART NUMBER	C-27 ADAPTER PART NUMBER	C-30 & C-40 ADAPTER PART NUMBER			
310A	C-30			016-0241-00	 <p>Each Main Frame Assembly includes a cable release and standard camera instruction manual.</p>		
317	C-30			016-0241-00			
321A	C-30			016-0242-00			
360	C-30			016-0241-00			
422	C-30			integral			
453	C-30 or C-40			integral			
454	C-30 or C-40			integral			
491	C-30			integral			
502A	C-27-547 or C-27G						
503	C-12 or C-27	016-0226-00	016-0225-00	016-0243-00			
504	C-12 or C-27						
507	C-12						
515A	C-12						
516	C-12						
519	C-27-662R					integral	
520	C-27-549		016-0225-00				
529	C-27	016-0217-00*	016-0224-00	016-0244-00			
531A	C-12	016-0226-00	016-0225-00	016-0243-00	 <p>C-12 Main Frame with beam-splitting mirror and on-axis binocular viewing. Part No. 122-0635-00</p>		
533A	C-12						
535A	C-12						
536	C-12						
543B	C-12 or C-27						
544	C-12 or C-27						
545B	C-12 or C-27						
546	C-12 or C-27						
547	C-12 or C-27						
549	C-12						
551	C-12						
555	C-12 or C-27	016-0217-00	016-0224-00	016-0244-00			
556	C-12 or C-27						
561A	C-12 or C-27						
564	C-12 or C-27						
565	C-27-547 or 27G				016-0226-00	016-0225-00	016-0243-00
567	C-27				016-0217-00	016-0224-00	016-0244-00
568	C-27						
575	C-12	016-0226-00	016-0225-00	016-0243-00			
581A	C-27-662R						
585A	C-27-662R						
601	C-30			016-0248-00			
647A	C-27-662R		016-0223-00				
661	C-12	016-0226-00	016-0225-00	016-0243-00			
some Hewlett-Packard	call Tektronix Field Office or Representative	016-0229-00	016-0228-00				
some Fairchild DuMont			016-0227-00				













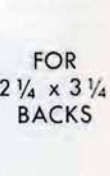

*Requires slight modification to Type 529.

C-27 Main Frame with direct binocular viewing, removable viewing tunnel and maximum light transmission from CRT to film.
Part No. 122-0676-00



C-40 Main Frame with swing-away hinging for viewing from either side.
Order 122-0741-01
Includes light seal for Type 422 and 491 (354-0279-00); light seal for Type 453 and 454 (354-0280-00).

CAMERA COMPONENTS

INTERCHANGEABLE LENSES	REAR FRAMES	INTERCHANGEABLE FILM BACKS	ACCESSORIES FOR GRAFLOK BACKS
 <p>f/1.9—1:0.7 Film Economy Medium Writing Rate Pi Alphax or Ilex No. 3X Shutter Order 122-0547-00</p>	 <p>Standard Frame Order 122-0591-00</p>	 <p>Polaroid Land 3 1/4 x 4 1/4 Pack-Film Back, 8 exp Order 122-0671-00 Focus Plate for above. Order 387-0893-00</p>	<div style="display: flex; justify-content: space-between;"> <div style="width: 45%;"> <p>FOR 4 x 5 BACKS</p>  <p>Cut-Film Holder 2 exposures Part No. 122-0700-00</p> <p>Dark Slide for above Part No. 122-0702-00</p> </div> <div style="width: 45%;"> <p>FOR 2 1/4 x 3 1/4 BACKS</p>  <p>Cut-Film Holder 2 exposures Part No. 122-0699-00</p> <p>Dark Slide for above Part No. 122-0701-00</p> </div> </div>
 <p>f/1.9—1:0.5 High Writing Rate Pi Alphax or Ilex No. 3X Shutter Order 122-0549-00</p>	 <p>Power Supply Frame for Model 3 Shutter Actuator Refer to page 290.</p>	<p>Polaroid Land 3 1/4 x 4 1/4 Roll-Film Back, 8 exp Order 122-0603-00 Focus Plate for above. Order 387-0460-00</p> <p>(Focus Plates not needed if Graflok Back is available.)</p>	 <p>Film-Pack Adapter 12 exposures Part No. 122-0704-00</p> <p>Film-Pack Adapter 12 exposures Part No. 122-0703-00</p>
 <p>f/1.4—1:1 Precise full-size Image High Writing Rate Pi Alphax No. 3 Shutter Order 122-0608-00</p>	<p>ROTATING SLIDE ADAPTER</p>	 <p>4 x 5 Graflok Back with Focusing Screen accepts standard cut-film holders, film-pack adapters, roll- film (120) holders, Polaroid 4 x 5 Film Holder. Order 122-0604-00</p>	 <p>Film Holder 6 exposures Part No. 122-0706-00</p> <p>Film Holder 6 exposures Part No. 122-0705-00</p>
 <p>f/1.3—1:0.5 Ultra-High Writing Rate Ilex No. 3X Shutter Order 122-0662-00</p>	 <p>Adapts Polaroid or Graflok Back to rear frame. Locks in 9 positions for multiple exposures. Order 122-0739-00</p>	<p>2 1/4 x 3 1/4 Graflok Back with Focusing Screen accepts standard cut-film holders, film-pack adapters, roll-film (120) holders. Order 016-0233-00</p>	 <p>120 Roll-Film Holder 8 exposures, 2 1/4 x 3 1/16 Use with 1:0.7 lens Part No. 122-0736-00</p> <p>120 Roll-Film Holder 10 exposures, 2 1/4 x 2 3/4 Use with 1:0.5 lens Part No. 122-0736-01</p> <p>120 Roll-Film Holder 12 Exposures, 2 1/4 x 2 1/4 Use with 1:0.5 lens Part No. 122-0736-02</p> <p>Polaroid Land 4 x 5 Film Holder. Part No. 016-0201-00</p>
 <p>f/1.9—1:0.85 General Purpose Pi Alphax or Ilex No. 3X Shutter Order 122-0692-00</p> <p>Shutter flash-sync cord, for above lenses, X syn- chronization closes con- tacts when shutter is fully open. Order 175-0461-00</p>			<p>120 Roll-Film Holder 8 exposures, 2 1/4 x 3 1/16 Use with 1:0.7 lens Part No. 122-0735-00</p> <p>120 Roll-Film Holder 10 exposures, 2 1/4 x 2 3/4 Use with 1:0.5 lens Part No. 122-0735-01</p> <p>120 Roll-Film Holder 12 Exposures, 2 1/4 x 2 1/4 Use with 1:0.5 lens Part No. 122-0735-02</p>

SCOPE-MOBILE[®] CARTS

The Type 200-1 Scope-Mobile[®] Cart is specifically designed for the Types 453 and 454 Portable Oscilloscopes, and the Type 491 Spectrum Analyzer. A separate version, the Type 200-2, is designed for use with the Type 422 Portable Oscilloscope.

These new oscilloscope carts occupy less than 18 inches

of aisle space. With their large wheels and unique design, they can easily be moved up and down stairs. Friction locks on the oscilloscope tray permit the instrument to be positioned at any angle for convenient viewing. Storage space is provided at the base of the cart for accessories or associated instruments.

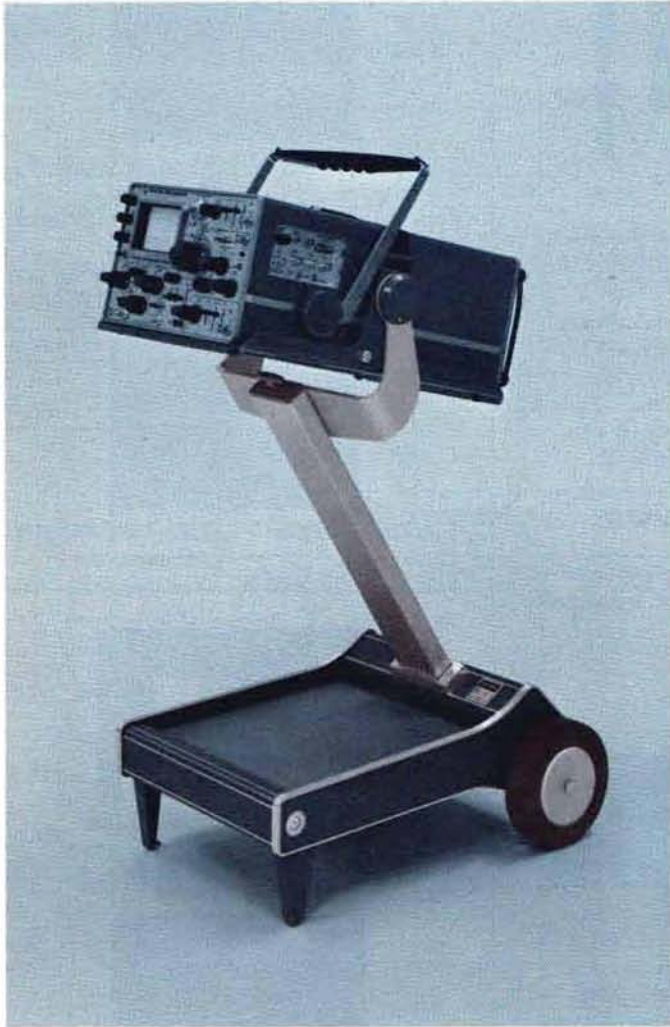

ADJUSTABLE TRAY friction-locks in any position from 0° to 60°. A finger-tip latch on the pedestal locks the tray for transporting.

MECHANICAL FEATURES include cast-aluminum construction with six-inch rubber wheels.

OVERALL DIMENSIONS are approximately 28³/₄ inches high by 17 inches wide by 19 inches deep. Storage area in the base measures 12 inches by 12 inches, and ³/₄ inches deep.



NET WEIGHT is 19 lb.

TYPE 200-1 SCOPE-MOBILE[®] CART for Types 453, 454, 491

TYPE 200-2 SCOPE-MOBILE[®] CART for Type 422

Please refer to Terms and Shipment, General Information page.

SCOPE-MOBILE® CARTS

Seven models comprise the 201 through 205-Series Scope-Mobile® Carts featuring tilt locking in one of nine tray positions. These tilt-lock models include the Types 201-1, 201-2, 202-1, 202-2, 205-1, 205-2, 205-3. The three models ending with -1 have a storage drawer for holding accessory items. The models ending with -2 and -3 have a storage drawer and a plug-in carrier for housing plug-in units. Three AC-receptacles are located at the rear of the storage drawer for supplying power to the oscilloscope and associated instruments. A flange around the receptacles provides convenient storage for the power cord when not in use. All tilt-lock models come equipped with front-wheel brakes.

ADJUSTABLE TRAY tilt-locks in six 4.5° steps in the upward direction from the horizontal axis.

MECHANICAL FEATURES include aluminum construction, 5 inch rubber wheels with front wheel brakes, and linoleum-topped steel shelf at the bottom.

OVERALL DIMENSIONS are approximately 36 inches high by 19½ inches wide by 29 inches deep for the 201-1, -2 and 202-1, -2; 36 inches high by 23½ inches wide by 29 inches deep for the 205-1, -2 and -3.

Either the storage drawer or the storage drawer and plug-in carrier combination can be ordered separately to modernize older Scope-Mobile® Carts.

014-0012-00 drawer for 201-1

014-0013-00 drawer/plug-in carrier combination for 201-2

014-0014-00 drawer for 202-1

014-0015-00 drawer/plug-in carrier combination for 202-2

014-0032-00 drawer/1-, 80-, letter-series plug-in carrier combination for 205-2

014-0033-00 drawer/2-, 3-, 10-, 11-series plug-in carrier combination for 205-3

Please refer to Terms and Shipment, General Information page.



MODEL	PLUG-IN CARRIER	TRAY WIDTH	TRAY DESIGNED FOR TEKTRONIX OSCILLOSCOPE TYPE	BOTTOM TRAY DIMENSIONS**	NET WEIGHT
201-1	NO	10½ in	503, 504, 515A, 516, 561A, 564, 647A		≈37 lb
201-2	Holds two 2-, 3-, 10-, or 11-series plug-ins				≈38½ lb
202-1 MOD 52	NO	14¾ in	519	15½ in x 25 in	≈43¾ lb
202-1	NO	14 in	502A*, 507, 530-, 540-, 580-series; 551, 555, 575, 661		≈40¾ lb
202-2	Holds two 1-, 80-, or letter-series plug-ins				≈42¾ lb
205-1	NO	17¾ in	520, 556, 565, 567, 568, and rackmount instruments	18½ in x 25 in	≈45¾ lb
205-2	Holds three 1- or letter-series plug-ins				≈48¾ lb
205-3	Holds four 2-, or 3-series plug-ins				≈48¾ lb

*Requires special adapter, order 040-0365-00

**Usable dimensions may be limited by height required.

PROBES

Tektronix offers a choice of voltage and current probes designed to be compatible with circuit measurement requirements. The probes are designed to monitor the signal source with minimum circuit loading while maintaining waveform fidelity.

A prime consideration in selecting the proper probe is the circuit loading effect of the oscilloscope/probe combination. The probe with the highest input impedance (lowest input capacitance and highest input resistance) will provide the least circuit loading. Typically, as frequency increases and risetime decreases, the capacitance loading becomes most important; at low frequencies the resistive loading becomes most important.

Capacitive loading of voltage probes is an important consideration when measuring fast-risetime pulses. The time required to charge the input capacitance of the probe from 10% to 90% is $t_r = 2.2 R_{source} C_{probe}$. Current probes have minimum capacitive loading (typically 1 pF). With current probes the stray capacitance loading can be reduced by inserting the current probe on the ground or B+ side of the load resistor.

Probe attenuation ratio is also an important consideration. The oscilloscope must have enough gain to compensate for the attenuation of the probe.

To help you select the right probe for your application, the probe reference chart provides a quick comparison of Tektronix probe parameters. The following factors should be considered in making your selection:

1. Be sure the desired probe will match the input resistance and capacitance of the oscilloscope used, and is equipped with the proper connector.
2. Select a probe with adequate risetime and bandwidth for the oscilloscope and the application.
3. When considering input impedance, the probe with the lowest input capacitance will generally provide the most accurate measurements.
4. The instrument descriptions in this catalog list standard and optional accessories, and should be consulted for specific probe recommendations.
5. If you desire help in selecting the right probe for your application, please consult your local Tektronix Field Engineer, Representative or Distributor.

TEKTRONIX PROBES

(According to use area)

Recommended Use Area is the frequency range where the probe will have a minimum effect on the oscilloscope's measurement accuracy.

Probe Only Risetime is the risetime of the probe driven from a terminated 50-Ω source. From this figure the risetime of the probe/oscilloscope system may be calculated.

$$t_{r\text{ system}}^2 = t_{r\text{ probe}}^2 + t_{r\text{ oscilloscope}}^2$$

Bandwidth (3-dB down) of the probe/oscilloscope system may be calculated, knowing the system risetime and using the formula, $(bw) (t_r) = 0.35$.

CURRENT PROBES

Recommended Use Area	Probe Risetime	Minimum Defl. Factor	Type	Page
35 kHz to 1 GHz	0.35 ns	5 mV/mA	P6040/CT 1	312
1.2 kHz to 150 MHz	0.5 ns	1 mV/mA	P6041/CT 2	313
8.5 kHz to 150 MHz	1.75 ns	1 mA/mV	P6020 Miniature	304
100 Hz to 70 MHz	5 ns	1 mA/div	P6020/134 Miniature	304
450 Hz to 60 MHz	5.8 ns	2 mA/mV	P6019	304
DC-to-50 MHz	7 ns	1 mA/div	P6042	314
12 Hz to 40 MHz	9 ns	1 mA/div	P6019/134	304

VOLTAGE PROBES

Recommended Use Area	Probe Only Risetime	Probe Input R,C	Attenuation	Type	Page
DC-to-3.5 GHz	0.1 ns	0.7 pF, 500 Ω	10X	P6034 Miniature	309
DC-to-1.7 GHz	0.2 ns	0.6 pF, 5 k Ω	100X	P6035 Miniature	310
DC-to-1 GHz	0.35 ns	2 pF, 100 k Ω	1X	P6038 Sampling	311
DC-to-850 MHz	0.4 ns	3.6 pF, 10 M Ω	10X	P6032	308
DC-to-230 MHz	1.5 ns	5.5 pF, 10 M Ω	1X	P6045 FET	316
DC-to-150 MHz	1.2 ns	10 pF, 10 M Ω	10X	P6047 Miniature	320
	2 ns	2.5 pF, 10 M Ω	100X	P6009	299
DC-to-100 MHz	3 ns	7.5 pF, 10 M Ω	10X	P6008	299
	3.5 ns	10 pF, 1 M Ω	0.1X	P6046 Differential Probe & Amplifier	318
DC-to-50 MHz	4 ns	2.7 pF, 100 M Ω	1000X	P6015 High Voltage Up to 40 kV	303
	2 ns	10 pF, 10 M Ω	10X	P6010 Miniature	300
DC-to-33 MHz	7 ns	3 pF, 100 M Ω	1000X	P6013A High Voltage Up to 12 kV	302
	5 ns	7 pF, 10 M Ω	10X	P6006	298
	7 ns	2 pF, 10 M Ω	100X	P6007	298
	12 ns	50 pF, 1 M Ω	1X	P6011 Miniature	300
	5 ns	11.5 pF, 10 M Ω	10X	P6012 Miniature	301
	7 ns	12 pF, 8 M Ω	10X	P6023	306
	10 ns	100 pF, 1 M Ω	1X	P6027	307
	10 ns	100 pF, 1 M Ω	1X	P6028	307

P6006

DC-to-33 MHz 10X VOLTAGE PROBE

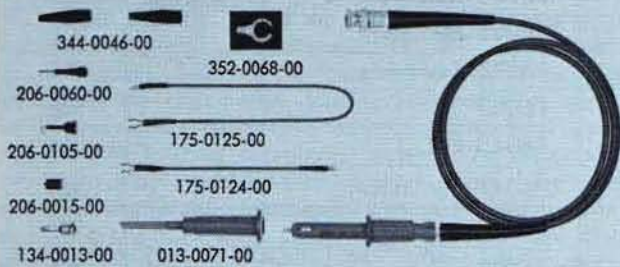

The P6006 is a general-purpose probe designed for use with Tektronix DC-to-33 MHz Oscilloscopes. The probe can be compensated to match all Tektronix Plug-ins and Oscilloscopes with input capacitances of 15 pF to 47 pF and input resistance of 1 M Ω .

ATTENUATION is 10X.

INPUT RESISTANCE is 10 megohms.

INPUT CAPACITANCE for standard length probe is approximately 7 pF when used with an instrument having a 20 pF input capacitance; 8.5 pF for the 6 ft version, 11 pF for the 9 ft version, 13 pF for the 12 ft version.

PROBE RISETIME is approximately 5 ns.

TYPICAL RISETIME of probe, Type 1A2 Plug-In Unit, and Type 545B Oscilloscope is 12 ns.

VOLTAGE RATING is 600 V DC or AC peak to peak.*

P6006 3.5 FT PROBE, order 010-0127-00 BNC or 010-0125-00 UHF

P6006 6 FT PROBE, order 010-0160-00 BNC or 010-0158-00 UHF

P6006 9 FT PROBE, order 010-0146-00 BNC or 010-0142-00 UHF

P6006 12 FT PROBE, order 010-0148-00 BNC or 010-0144-00 UHF

Includes: straight tip (206-0015-00); hook tip (206-0105-00); retractable hook tip (013-0071-00); spring tip (206-0060-00); banana plug (134-0013-00); two minigator clips (344-0046-00); probe holder (352-0068-00); 5 inch ground lead (175-0124-00); 12 inch ground lead (175-0125-00); instruction manual (070-0381-00).

*Peak to peak voltage derating is necessary for CW frequencies higher than 5.7 MHz when working into a 20 pF input, or higher than 3.6 MHz when working into a 47 pF input.

Please refer to Terms and Shipment, General Information page.

P6007

DC-to-33 MHz 100X VOLTAGE PROBE

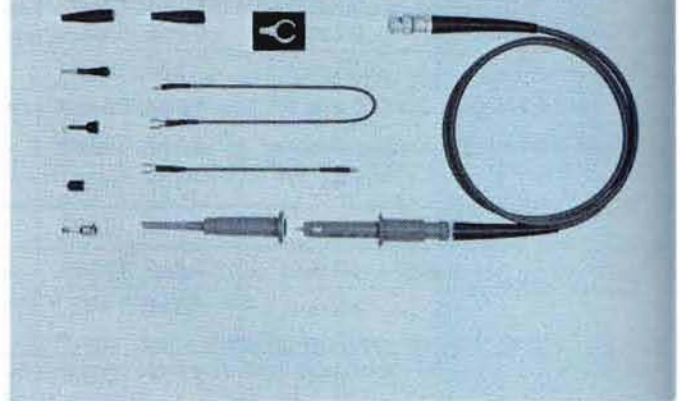

The P6007 low input-capacitance, high-voltage (1.5-kV) probe is designed for use with Tektronix DC-to-33 MHz Oscilloscopes. The probe can be compensated to match all Tektronix Plug-ins and Oscilloscopes with input capacitances of 15 pF to 47 pF and input resistance of 1 M Ω .

ATTENUATION is 100X.

INPUT RESISTANCE is 10 megohms.

INPUT CAPACITANCE for a standard length probe is approximately 2.0 pF when used with an instrument having a 20 pF input capacitance; 2.2 pF for the 6 ft version, 2.4 pF for the 9 ft version, 2.6 pF for the 12 ft version.

PROBE RISETIME is approximately 7 ns.

TYPICAL RISETIME of probe, Type 1A2 Plug-In Unit, and Type 545B Oscilloscope is approx 12.5 ns.

VOLTAGE RATING is 1.5 kV DC or AC RMS, 4.2 kV AC peak to peak.*

P6007 3.5 FT PROBE, order 010-0150-00 BNC or 010-0134-00 UHF

P6007 6-FT PROBE, order 010-0165-00 BNC or 010-0162-00 UHF

P6007 9-FT PROBE, order 010-0152-00 BNC or 010-0136-00 UHF

P6007 12-FT PROBE, order 010-0154-00 BNC or 010-0138-00 UHF

Includes: straight tip (206-0015-00); hook tip (206-0105-00); retractable hook tip (013-0071-00); spring tip (206-0060-00); banana plug (134-0013-00); two minigator clips (344-0046-00); probe holder (352-0068-00); 5 inch ground lead (175-0124-00); 12 inch ground lead (175-0125-00); instruction manual (070-0388-01).

*Peak to peak voltage derating is necessary for CW frequencies higher than 200 kHz. At 10 MHz, the maximum allowable peak to peak voltage is 2 kV. Above 10 MHz, additional derating is required depending on the input capacitance of the plug-in or instrument used.

Please refer to Terms and Shipment, General Information page.

P6008

DC-to-100 MHz 10X VOLTAGE PROBE

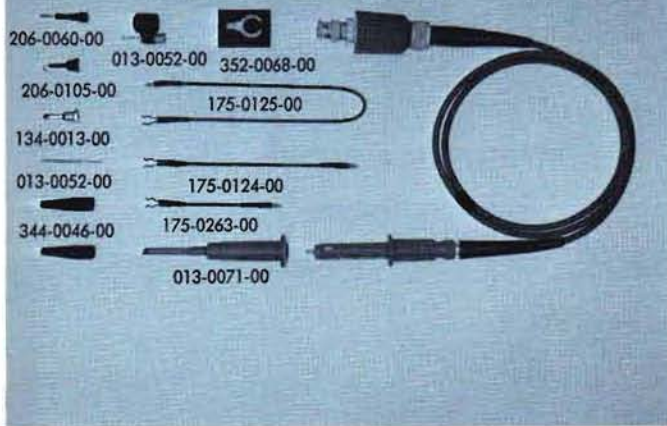

The P6008 is a general purpose probe designed for use with Tektronix DC-to-100 MHz Oscilloscopes. The probe can be compensated to match plug-ins and oscilloscopes with input capacitances of 8 pF to 50 pF and input resistance of 1 M Ω .

ATTENUATION is 10X

INPUT RESISTANCE is 10 megohms.

INPUT CAPACITANCE is approximately 7.5 pF.

PROBE RISETIME is less than 3 ns.

TYPICAL RISETIME of probe, Type 82 Plug-In Unit, and Type 580-Series Oscilloscope is 5 ns.

VOLTAGE RATING is 600 V DC or AC peak to peak.*

CABLE is 3.5 ft long, terminated with a BNC connector.

P6008 PROBE, order 010-0129-00

Includes: bayonet adapter (013-0052-00); hook tip (206-0105-00); retractable hook tip (013-0071-00); spring tip (206-0060-00); straight tip (206-0015-00); banana plug (134-0013-00); two mini-gator clips (344-0046-00); probe holder (352-0068-00); 3-inch ground lead (175-0263-00); 5-inch ground lead (175-0124-00); 12-inch ground lead (175-0125-00); instruction manual (070-0362-01).

OPTIONAL ACCESSORIES—see probe accessories at the rear of probe section.

*Peak to peak voltage derating is necessary for CW frequencies higher than 20 MHz. At 40 MHz, the maximum allowable peak to peak voltage is 300 V.

Please refer to Terms and Shipment, General Information page.

P6009

DC-to-150 MHz 100X VOLTAGE PROBE

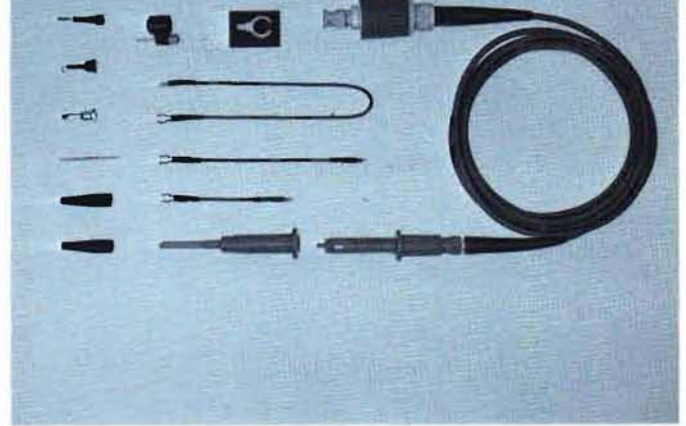

The P6009 low input capacitance, high-voltage (1.5-kV) probe is designed for use with Tektronix DC-to-150 MHz Oscilloscopes. The probe can be compensated to match plug-ins and oscilloscopes with input capacitance of 8 pF to 50 pF and input resistance of 1 M Ω .

ATTENUATION is 100X.

INPUT RESISTANCE is 10 megohms.

INPUT CAPACITANCE is 2.5 pF.

PROBE RISETIME is approximately 2 ns.

TYPICAL RISETIME of probe, Type 82 Plug-In Unit, and 580-Series Oscilloscope is 4.5 ns.

VOLTAGE RATING is 1.5 kV DC or AC RMS, 4 kV AC peak to peak.*

CABLE is 9 ft long, terminated with a BNC connector.

P6009 PROBE, order 010-0140-00

P6009 PROBE, for the Types 10A2A and 454 order 010-0170-00

Includes: bayonet adapter (013-0052-00); hook tip (206-0105-00); retractable hook tip (013-0071-00); spring tip (206-0060-00); straight tip (206-0015-00); banana plug (134-0013-00); two mini-gator clips (344-0046-00); probe holder (352-0068-00); 3-inch ground lead (175-0263-00); 5-inch ground lead (175-0124-00); 12-inch ground lead (175-0125-00); instruction manual (070-0401-00).

OPTIONAL ACCESSORIES—see probe accessories at the rear of probe section.

*Peak to peak voltage derating is necessary for CW frequencies higher than 300 kHz. At 40 MHz, the maximum allowable peak to peak voltage is 575 V.

Please refer to Terms and Shipment, General Information page.

P6010

DC-to-50 MHz 10X VOLTAGE PROBE

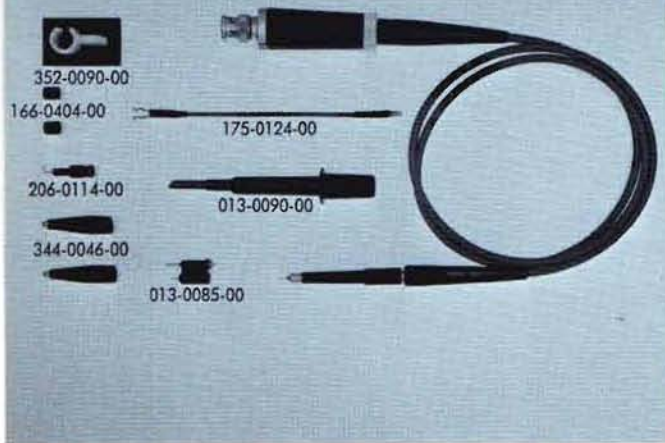

The P6010 is a miniature passive probe designed for use with Tektronix DC-to-50 MHz oscilloscopes. The probe is easily compensated for use with any instrument having an input capacitance of 14 to 21 pF.

Extra small in size, the P6010 is well suited for servicing sub-miniature circuits where easy access is required. In addition to the standard 3.5 ft length, the probe is available with a 6 ft or 9 ft cable at no additional cost.

ATTENUATION is 10X.

INPUT RESISTANCE is 10 megohms.

INPUT CAPACITANCE for the standard length probe is approximately 10 pF when used with instruments having a 14 to 21 pF input capacitance; 12 pF for the 6 ft version, 15.5 pF for the 9 ft version.

PROBE RISE TIME is less than 2 ns.

TYPICAL RISE TIME of probe with Type 453 Oscilloscope is 7 ns.

VOLTAGE RATING is 500 V DC, AC peak, or DC and AC peak combined.*

STANDARD CABLE is 3.5 ft long, terminated with a BNC connector.

P6010 3.5 FT PROBE, order 010-0188-00

P6010 6 FT PROBE, order 010-0185-00

P6010 9 FT PROBE, order 010-0201-00

Includes hook tip (206-0114-00); retractable hook tip (013-0090-00); bayonet ground adapter (013-0085-00); minigator clip (344-0046-00); probe holder (352-0090-00); 5 inch ground lead (175-0124-00); two insulating tubes (166-0404-00); instruction manual (070-0495-01).

OPTIONAL ACCESSORIES—see probe accessories at the rear of probe section.

*Peak voltage derating is necessary for CW frequencies higher than 2.5 MHz. At 20 MHz, the maximum allowable peak voltage is 175 V; 60 V at 60 MHz.

Please refer to Terms and Shipment, General Information page.

P6011

DC-to-33 MHz 1X VOLTAGE PROBE

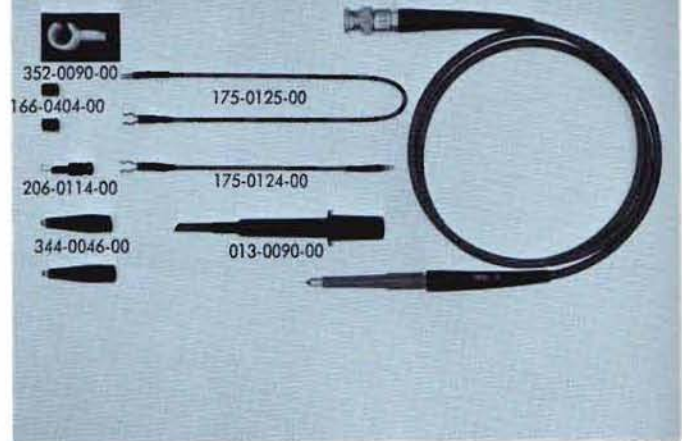

The P6011 1X Passive Probe can be used with all Tektronix general-purpose oscilloscopes. Like the P6010, the small size of the probe body makes it ideal for working on compact circuitry.

The probe cable utilizes a resistive center conductor for damping critical reflections, insuring maximum bandwidth. In addition to the standard 3.5 ft length, the probe is available with a 6 ft or 9 ft cable at no additional cost.

ATTENUATION is 1X.

INPUT RESISTANCE is 1 megohm, instrument input R included.

INPUT CAPACITANCE for standard length probe is approx 28 pF; 48 pF for the 6 ft version, instrument excluded.

PROBE RISE TIME for the standard cable length is less than 12 ns working into a plug-in with an input capacitance of 15 pF; less than 15 ns working into a plug-in with an input capacitance of 20 pF. The probe risetime of the 6 ft version is less than 15 ns into 15 pF or less than 17 ns into 20 pF. The probe risetime of the 9-ft version is less than 23 ns into 15 pF or less than 25 ns into 20 pF.

VOLTAGE RATING is 600 V DC, AC peak, or DC and AC peak combined.*

STANDARD CABLE is 3.5 ft long with a BNC connector.

P6011 3.5 FT PROBE, order 010-0193-00

P6011 6 FT PROBE, order 010-0190-00

P6011 9 FT PROBE, order 010-0229-00

Includes: hook tip (206-0114-00); retractable hook tip (013-0090-00); two minigator clips (344-0046-00); probe holder (352-0090-00); two insulating tubes (166-0404-00); 5 inch ground lead (175-0124-00); 12 inch ground lead (175-0125-00); instruction manual (070-0512-00).

OPTIONAL ACCESSORIES—see probe accessories at the rear of probe section.

*Peak voltage derating is necessary for CW frequencies higher than 0.5 MHz. When the probe is used with a plug-in having an input C of 20 pF, the maximum allowable peak voltage at 1 MHz is 510 V. At 5 MHz, the maximum is 100 V; 46 V at 10 MHz. When the probe is used with a plug-in having a 47 pF input, the allowable voltage will be lower by a ratio of 1:3.

Please refer to Terms and Shipment, General Information page.

P6012

DC-to-33 MHz
10X VOLTAGE PROBE

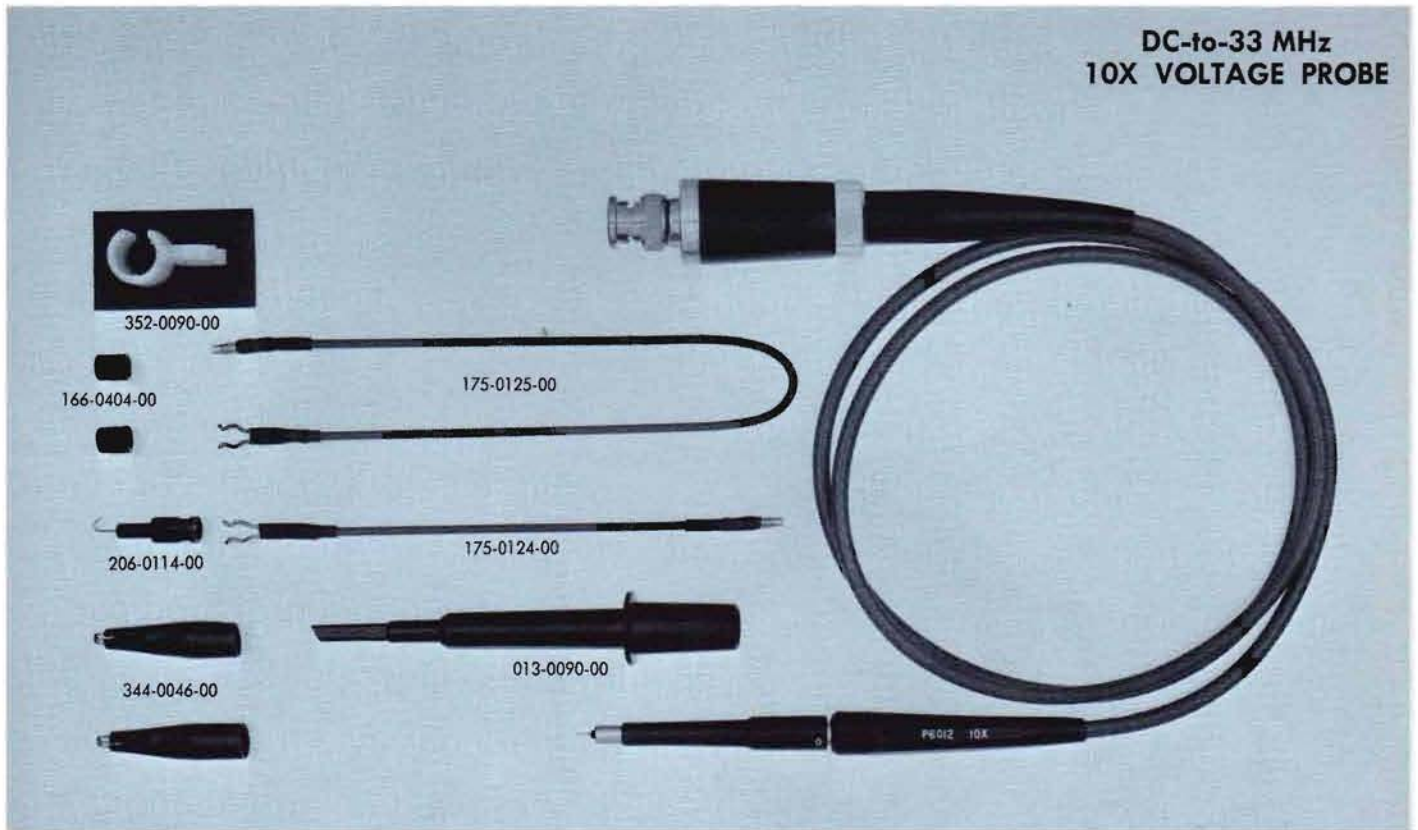

The new P6012 is a miniature general-purpose probe designed for use with oscilloscopes having bandwidths up to 33 MHz. The probe can be compensated to match all Tektronix plug-ins and oscilloscopes with input capacitances of 15 to 47 pF and input resistance of 1 M Ω .

Very small in size, the P6012 is well suited for applications involving subminiature circuitry. The probe is available with a 3.5 ft cable, or with a 6 ft cable at no additional cost.

ATTENUATION is 10X.

INPUT RESISTANCE is approximately 10 megohms.

INPUT CAPACITANCE of probe with 3.5 ft cable is 11.5 pF or less; 14.5 pF or less for the 6 ft version; 17 pF or less for the 9 ft version.

PROBE RISE TIME is 5 ns or less with 3.5 ft cable, 6 ns or less with 6 ft cable, 6.5 ns or less with the 9 ft cable.

VOLTAGE RATING is 500 V DC, AC peak, or DC and AC peak combined.*

PROBE CABLE is terminated with a BNC connector.

P6012 3.5 FT PROBE, order 010-0203-00

P6012 6 FT PROBE, order 010-0209-00

P6012 9 FT PROBE, order 010-0231-00

Includes: hook tip (206-0114-00); retractable hook tip (013-0090-00); two minigator clips (344-0046-00); probe holder (352-0090-00); 5 inch ground lead (175-0124-00); 12 inch ground lead (175-0125-00); two insulating tubes (166-0404-00); instruction manual (070-0601-01).

OPTIONAL ACCESSORIES—see probe accessories at the rear of probe section.

*Peak voltage derating is necessary for CW frequencies higher than 6 MHz. At 15 MHz the maximum allowable peak voltage is 210 V; 95 V at 33 MHz.

Please refer to Terms and Shipment General Information page.

P6013A

12 kV
1000X VOLTAGE PROBE



The P6013A provides 1000X attenuation for oscilloscope measurements of high amplitude waveforms or DC potentials up to 12 kV. Pulse frequency can be up to 100 kHz at 12 kV.

The probe can be compensated for oscilloscope input capacitance up to 60 pF.

ATTENUATION is 1000X.

INPUT RESISTANCE is 100 megohms.

INPUT CAPACITANCE is 3 pF.

PROBE RISETIME is less than 7 ns.

TYPICAL RISETIME of probe, Type 1A1 Plug-In Unit, and Type 545B Oscilloscope is 13 ns.

VOLTAGE RATING is 12 kV DC, peak pulse, or peak AC.*

CABLE is 10 ft long, terminated with a LOCKING BNC or UHF connector.

P6013A PROBE, order 010-0177-01 LOCKING BNC or 010-0181-01 UHF

Includes: compensating box (015-0083-00 BNC) or (015-0081-00 UHF); alligator clip (344-0005-00); probe holder (352-0056-00); storage case (202-0139-00); storage case tray† (436-0062-01); storage case pad† (004-0217-00); instruction manual† (070-0603-00).

†not shown

OPTIONAL ACCESSORIES—see probe accessories at the rear of probe section.

*peak to peak voltage derating is necessary for CW frequencies higher than 100 kHz. At 1 MHz, the maximum allowable peak to peak voltage is 5.5 kV.

Please refer to Terms and Shipment, General Information page.

P6015

40 kV
1000X VOLTAGE PROBE



The P6015 provides 1000X attenuation for oscilloscope measurements up to 40-kV peak. Voltage or duty cycle derating is necessary for RF voltages at frequencies over 100 kHz, or in environmental temperatures above 25°C.

The probe time constant can be adjusted to equal the oscilloscope input time constant for instruments with 12 pF to 50 pF input capacitance.

ATTENUATION is 1000X, adjustable $\pm 9\%$.

INPUT RESISTANCE is 100 megohms.

INPUT CAPACITANCE is approximately 2.7 pF.

PROBE RISETIME is approximately 4 ns.

TYPICAL RISETIME of the probe, Type 1A1 Plug-In Unit, and Type 545B Oscilloscope is 11.5 ns.

TEMPERATURE RANGE is 10°C to 55°C environmental temperature. Approximate temperature coefficient of nose resistor is -0.15% per degree centigrade. Calibration adjustments are necessary when environmental or nose resistor temperature changes.

VOLTAGE RATING is 40 kV peak AC or pulse, 20 kV DC or RMS continuous at 25°C environmental temperature.*

CABLE is 10 ft long, terminated with a locking BNC or UHF connector.

P6015 PROBE, order 010-0172-00 LOCKING BNC or 010-0132-00 UHF

Includes: compensating box (015-0049-00 BNC) or (015-0039-00 UHF); alligator clip (344-0005-00); probe holder (352-0056-00); can, dielectric (252-0120-00); silica-gel† (256-0570-00); storage case (202-0139-00); storage case tray† (436-0035-00); storage case pad† (004-0217-00); instruction manual† (070-0373-01).

†not shown.

OPTIONAL ACCESSORIES—see probe accessories at the rear of probe section.

*peak to peak voltage derating is necessary for CW frequencies higher than 100 kHz. At 10 MHz, the maximum allowable peak to peak voltage is 13 kV.

Please refer to Terms and Shipment, General Information page.

P6019

120 Hz-to-60 MHz CURRENT PROBE

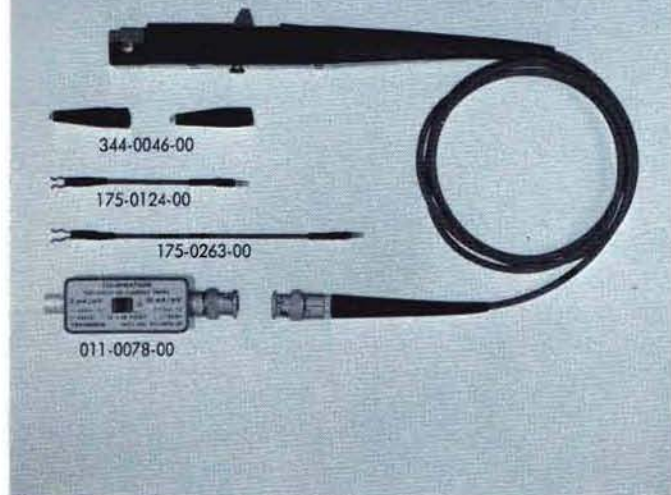

The P6019 and P6020 AC Current Probes, with passive termination or Type 134 Amplifier, are designed for use with Tektronix real-time oscilloscopes. They provide the facility for accurate current measurements over a wide range of frequencies without breaking the circuit under test. Simply open the spring-loaded slide, place the conductor* in the probe slot, and release the slide . . . no electrical connection required. The shielded probe head is not grounded when the slide is in the open position, eliminating accidental grounding of the circuit under test. Both probes have a five ft cable with a BNC connector.

P6020

935 Hz-to-150 MHz CURRENT PROBE

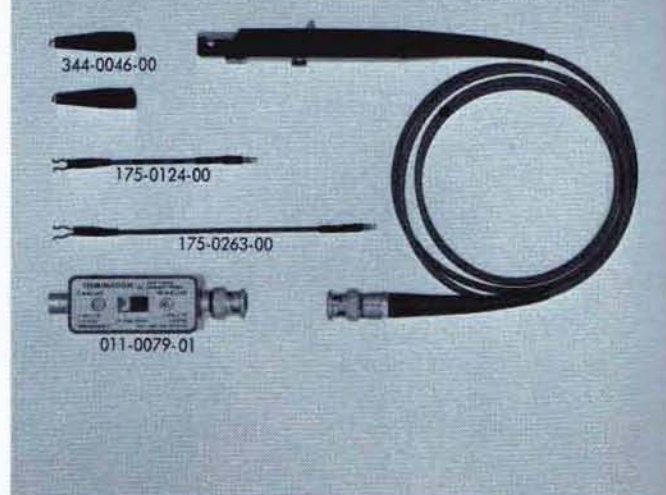

For general-purpose applications, the P6019 offers wide-band performance with excellent low-frequency characteristics. The extra-small size of the P6020 makes it ideally suited for measuring current in compact semiconductor circuits. The low frequency capabilities and sensitivity of both the P6019 and P6020 Probes can be expanded using the Type 134 Current Probe Amplifier. Either probe, with passive termination or with the amplifier, can be used with oscilloscopes having input resistances of 1-megohm or greater. The amplifier can also be used as an auxiliary voltage amplifier.

PERFORMANCE CHARACTERISTICS

	P6019 PROBE WITH PASSIVE TERMINATION	P6019 PROBE WITH TYPE 134 AMPLIFIER	P6020 PROBE WITH PASSIVE TERMINATION	P6020 PROBE WITH TYPE 134 AMPLIFIER
SENSITIVITY	2 mA/mV or 10 mA/mV; selected by termination switch. Accuracy $\pm 3\%$.	Switched current ampli- fier steps from 1 mA/div to 1 A/div (with 50 mV/ div oscilloscope setting). Accuracy $\pm 3\%$.	1 mA/mV or 10 mA/mV; selected by termination switch. Accuracy $\pm 3\%$.	Switched current ampli- fier steps from 1 mA/div to 1 A/div (with 50 mV/ div oscilloscope setting). Accuracy $\pm 3\%$.
HIGH FREQ (-3 dB)†	60 MHz	≥ 40 MHz	200 MHz	≥ 70 MHz
LOW FREQ (-3 dB)†	450 Hz at 2 mA/mV. 120 Hz at 10 mA/mV.	≤ 12 Hz (within 0.4 dB at 30 Hz)	8.5 kHz at 1 mA/mV. 935 Hz at 10 mA/mV.	≤ 100 Hz
RISETIME†	≤ 5.8 ns	≤ 9 ns	≤ 1.75 ns	≤ 5 ns
ABERRATIONS (first 50 ns of display)	$\leq 4\%$	$\leq 5\%$ from 1 mA to 20 mA. $\leq 6\%$ from 50 mA to 1 A.	$\leq 4\%$ to 100 MHz	$\leq 5\%$ from 1 mA to 20 mA. $\leq 6\%$ from 50 mA to 1 A.
FLATNESS	$\leq 4\%$ of 10 μ s square pulse at 2 mA/mV. $\leq 4\%$ of 35 μ s square pulse at 10 mA/mV.	$\leq 3\%$ tilt during 400 μ s of displayed square- wave.	$\leq 4\%$ of 1 μ s square pulse at 1 mA/mV. $\leq 4\%$ of 10 μ s square pulse at 10 mA/mV.	$\leq 3\%$ tilt during 80 μ s of displayed square- wave.
NOISE		≤ 150 μ A		≤ 150 μ A.
MAXIMUM CURRENT	15 A Peak to Peak.	15 A Peak to Peak.	6 A Peak to Peak.	6 A Peak to Peak.
MAXIMUM VOLTAGE	600 V	600 V	600 V	600 V

*Up to 0.150 inch diameter with P6019; up to 0.100 inch with P6020.

†Bandwidth and risetime do not include indicator.

CURRENT PROBE AMPLIFIER

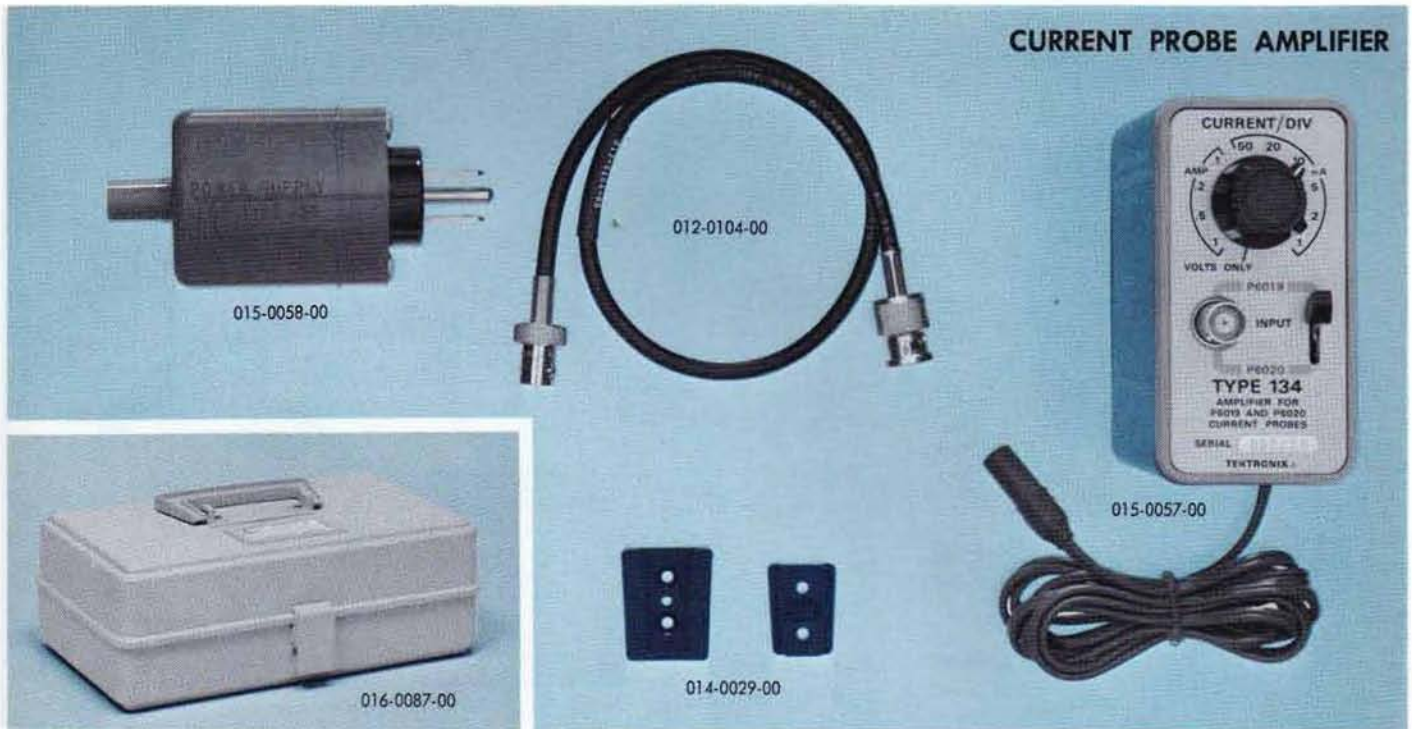

The Type 134 is used to extend the measurement capabilities of the P6019 or P6020 Current Probe. An INPUT switch on the front panel of the amplifier establishes the appropriate gain setting for the probe in use. A CURRENT/DIV switch provides calibrated current steps from 1 mA/div to 1 A/div (with the oscilloscope or plug-in unit adjusted for a deflection factor of 50 mV/div).

The Type 134 can also be used as an auxiliary voltage amplifier by placing the current/div switch in the VOLTS position.

DEFLECTION FACTOR: (with 50 mV/div oscilloscope input setting) 1 mV/div or 0.4 mV/div.

GAIN: 50 or 125, $\pm 3\%$. Selected by lever switch.

IMPEDANCE: (input and output) approx 50 Ω , AC-coupled.

BANDWIDTH: 8 Hz to 54 MHz at a gain of 50; 10 Hz to 30 MHz at a gain of 125 (3-dB down).

TYPE 134 AMPLIFIER ONLY (015-0057-00)

POWER SUPPLY ONLY, 115 V (015-0058-00)

POWER SUPPLY ONLY, 230 V (015-0059-00)

ORDERING INFORMATION

P6019

P6019 PROBE WITH PASSIVE TERMINATION
(015-0065-00)

P6019 PROBE (010-0196-00)

P6019 PASSIVE TERMINATION (011-0078-00)

Probe includes: 5 inch ground lead (175-0124-00); 3 inch ground lead (175-0263-00); two alligator clips (344-0046-00); two instruction manuals (070-0524-00).

P6019 PROBE, TYPE 134 AMPLIFIER WITH 115 V POWER SUPPLY
(015-0067-00)

P6019 PROBE, TYPE 134 AMPLIFIER WITH 230 V POWER SUPPLY
(015-0068-00)

Probe/amplifier includes: hanger assembly (014-0029-00); cable, coax, 18 inches (012-0104-00); carrying case (016-0087-00); 5 inch ground lead (175-0124-00); 3 inch ground lead (175-0263-00) two alligator clips (344-0046-00); two instruction manuals (070-0524-00).

CALIBRATOR ADAPTER, BNC (013-0092-00)

P6020

P6020 PROBE WITH PASSIVE TERMINATION
(015-0066-00)

P6020 PROBE (010-0197-00)

P6020 PASSIVE TERMINATION (011-0079-01)

Probe includes: 5 inch ground lead (175-0124-00); 3 inch ground lead (175-0263-00); two alligator clips (344-0046-00); two instruction manuals (070-0524-00).

P6020 PROBE, TYPE 134 AMPLIFIER WITH 115 V POWER SUPPLY
(015-0069-00)

P6020 PROBE, TYPE 134 AMPLIFIER WITH 230 V POWER SUPPLY
(015-0070-00)

Probe/amplifier includes: hanger assembly (014-0029-00); cable, coax, 18 inches (012-0104-00); carrying case (016-0087-00); 5 inch ground lead (175-0124-00); 3 inch ground lead (175-0263-00) two alligator clips (344-0046-00); two instruction manuals (070-0524-00).

OPTIONAL ACCESSORIES

ADAPTER, BNC to UHF (103-0015-00)

P6023

DC-to-33 MHz 10X VOLTAGE PROBE

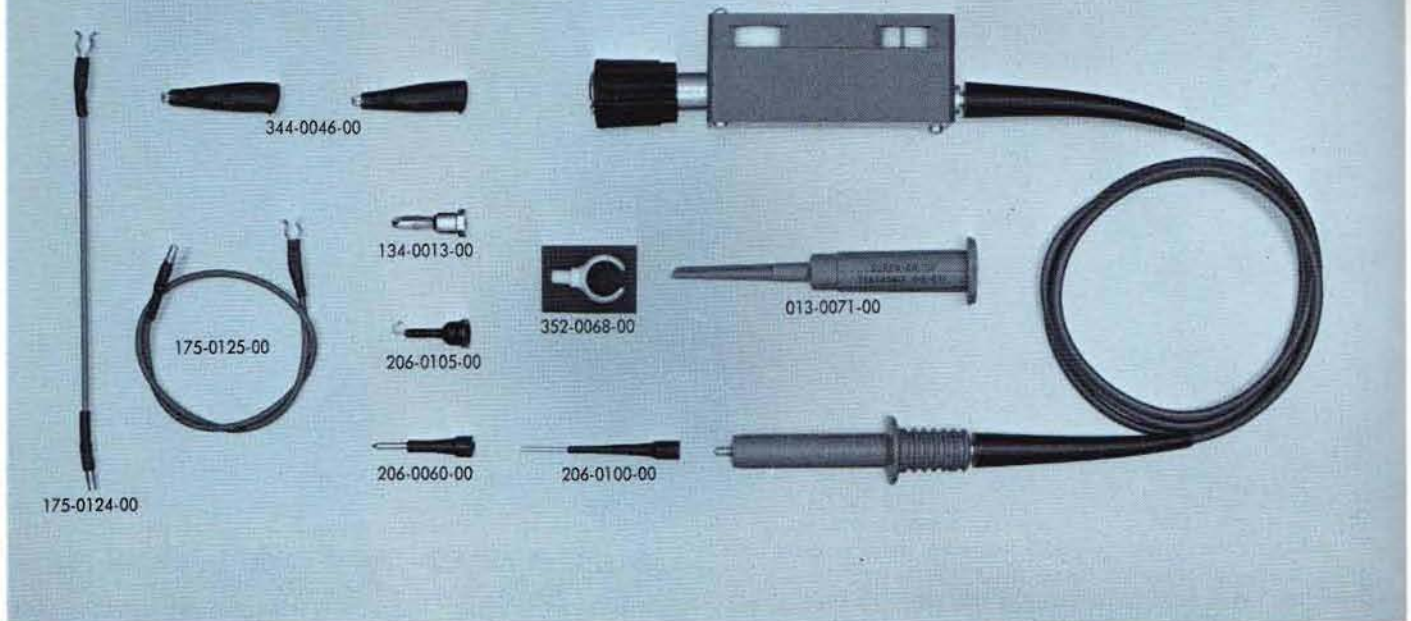

The P6023 Low-Capacitance Probe is designed for use with Tektronix differential preamplifiers.

The probe can be adjusted to match plug-in input capacitance ranging from 20 pF to 50 pF. The X10 attenuation ratio is adjustable over a $\pm 2.5\%$ range to compensate for differences in the input resistance of the plug-in unit. When two P6023 probes are used to drive the two inputs of a differential amplifier, the ability to change the attenuation ratio of one probe versus the other helps to maintain the common-mode rejection ratio of the system.

ATTENUATION is 10X, adjustable $\pm 2.5\%$.

INPUT RESISTANCE is approximately 8 megohms.

INPUT CAPACITANCE is approximately 12 pF when used with an instrument having a 20 pF or 47 pF input capacitance.

PROBE RISE TIME is less than 7 ns.

TYPICAL RISE TIME of probe, Type W Plug-In Unit, and Type 545B Oscilloscope is 17 ns.

VOLTAGE RATING is 1000 V DC or AC peak to peak.*

CABLE is 3.5 ft long, terminated with a locking BNC or UHF connector.

P6023 PROBE, order 010-0167-00 LOCKING BNC or 010-0065-00 UHF

Includes: spring tip (206-0060-00); hook tip (206-0105-00); retractable hook tip (013-0071-00); calibration tip (206-0100-00); banana plug (134-0013-00); two minigator clips (344-0046-00); probe holder (352-0068-00); 5 inch ground lead (175-0124-00); 12 inch ground lead (175-0125-00); instruction manual (070-0294-01).

OPTIONAL ACCESSORIES—see probe accessories at the rear of probe section.

*Peak to peak voltage derating is necessary for CW frequencies higher than 5 MHz. At 20 MHz, the maximum allowable peak to peak voltage is 300 V.

Please refer to Terms and Shipment, General Information page.

P6027

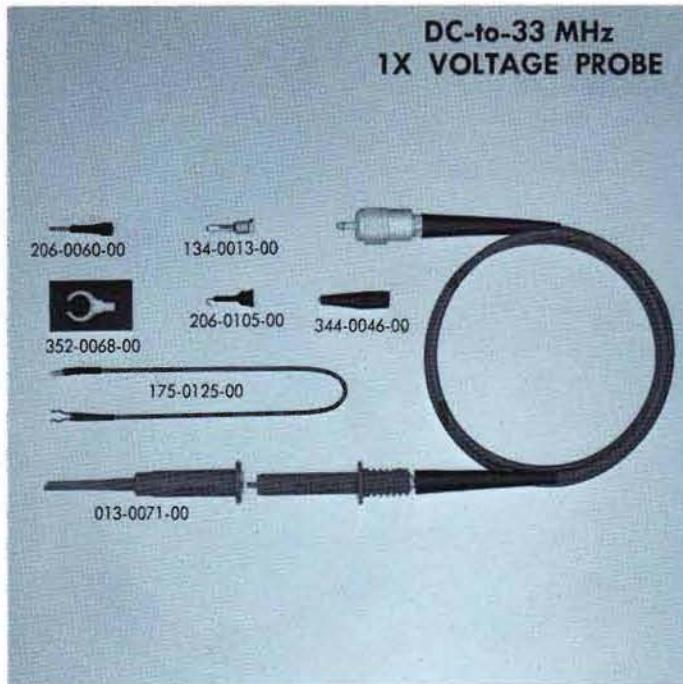

The P6027 is a general-purpose 1X voltage probe designed for use with Tektronix DC-to-33 MHz Oscilloscopes that have UHF input connectors.

In addition to the standard 3.5 ft cable length, the P6027 is available in cable lengths of 6 ft, 9 ft and 12 ft, at no additional cost. Insertion loss increases with probe cable length.

ATTENUATION is 1X.

INPUT RESISTANCE is 1 megohm, instrument input R included.

INPUT CAPACITANCE for standard length probe is approx 30 pF, 47 pF for the 6-ft version, 70 pF for the 9-ft version and 92 pF for the 12-ft version, instrument excluded. For total input capacitance of the system, add input C of instrument.

PROBE RISETIME is approximately 10 ns.

TYPICAL RISETIME of probe, Type K Plug-In Unit, and Type 540-Series Oscilloscope is 16 ns.

VOLTAGE RATING is 600 V DC or AC peak to peak.*

*peak to peak voltage derating is necessary for CW frequencies higher than 1 MHz. At 10 MHz, the maximum allowable peak to peak voltage is 60 V.

STANDARD CABLE is 3.5 ft long, terminated with a UHF connector.

P6027 3.5-FT PROBE, order 010-0070-00

P6027 6-FT PROBE, order 010-0071-00

P6027 9-FT PROBE, order 010-0072-00

P6027 12-FT PROBE, order 010-0073-00

Includes: hook tip (206-0105-00); retractable hook tip (013-0071-00); spring tip (206-0060-00); banana plug (134-0013-00); minigator clip (344-0046-00); probe holder (352-0068-00); 12-inch ground lead (175-0125-00); parts list.

OPTIONAL ACCESSORIES—see probe accessories at the rear of probe section.

Please refer to Terms and Shipment, General Information page.

P6028

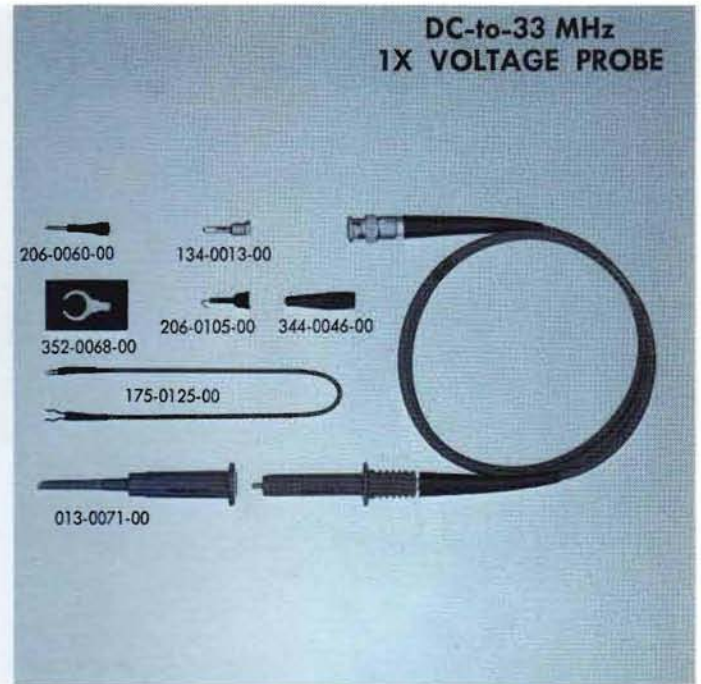

The P6028 is a general-purpose 1X voltage probe designed for use with Tektronix DC-to-33 MHz Oscilloscopes that have BNC input connectors.

In addition to the standard 3.5 ft cable length, the P6028 is available in cable lengths of 6 ft, 9 ft and 12 ft, at no additional cost. Insertion loss increases with probe cable length.

ATTENUATION is 1X.

INPUT RESISTANCE is 1 megohm, instrument input R included.

INPUT CAPACITANCE for standard length probe is approx 30 pF, 47 pF for the 6-ft version, 70 pF for the 9-ft version and 92 pF for the 12-ft version, instrument excluded. For total input capacitance of the system, add input C of instrument.

PROBE RISETIME is approximately 10 ns.

TYPICAL RISETIME of probe, Type K Plug-In Unit, and Type 540-Series Oscilloscope is 16 ns.

VOLTAGE RATING is 600 V DC or AC peak to peak.*

*peak to peak voltage derating is necessary for CW frequencies higher than 1 MHz. At 10 MHz, the maximum allowable peak to peak voltage is 60 V.

STANDARD CABLE is 3.5 ft long, terminated with a BNC connector.

P6028 3.5-FT PROBE, order 010-0074-00

P6028 6-FT PROBE, order 010-0075-00

P6028 9-FT PROBE, order 010-0076-00

P6028 12-FT PROBE, order 010-0077-00

Includes: hook tip (206-0105-00); retractable hook tip (013-0071-00); spring tip (206-0060-00); banana plug (134-0013-00); minigator clip (344-0046-00); probe holder (352-0068-00); 12 inch ground lead (175-0125-00); parts list.

OPTIONAL ACCESSORIES—see probe accessories at the rear of probe section.

Please refer to Terms and Shipment, General Information page.

P6032

DC-to-800 MHz
10X VOLTAGE PROBE

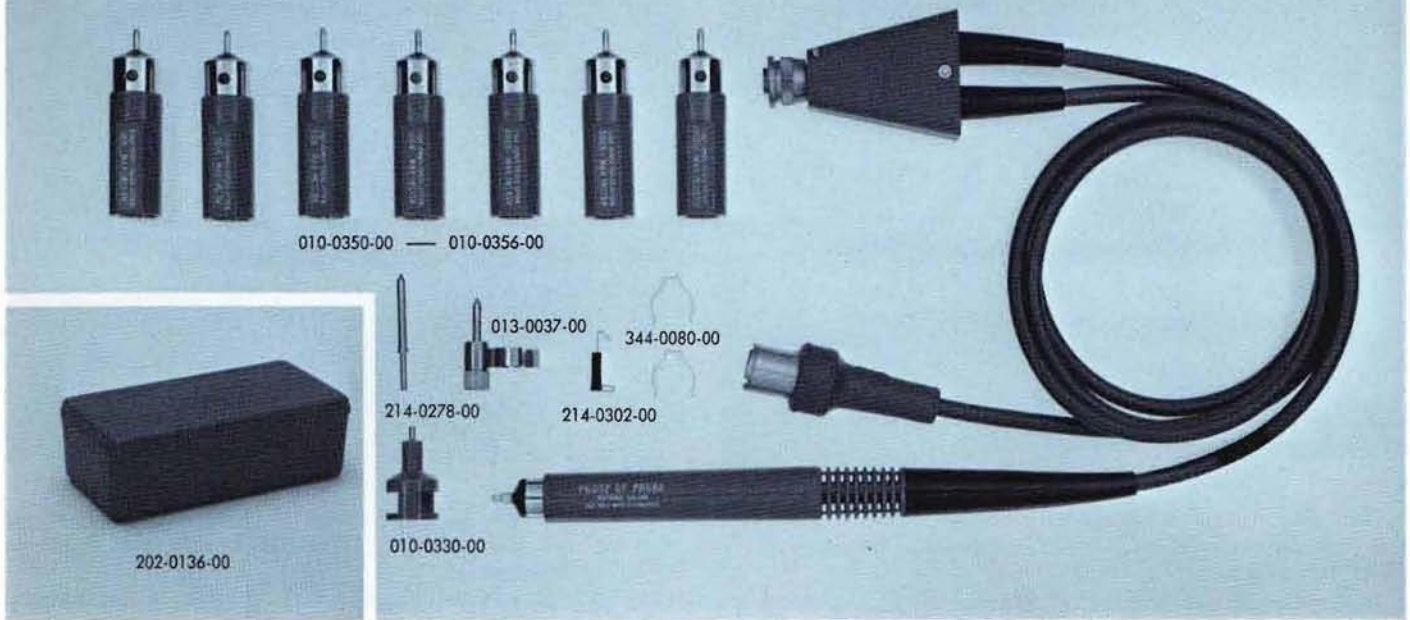

The P6032 is a wide-band cathode-follower probe designed for use with Tektronix vertical sampling plug-in units, such as the Type 1S1, 3S1, 4S1, or 4S2A.

The attenuator heads are individually adjustable for proper AC attenuation.

RISETIME is typically 0.4 ns for probe and attenuator head.

MAXIMUM OUTPUT is ± 150 mV into a 50- Ω load.

SIGNAL DELAY is approximately 10 ns.

POWER REQUIREMENTS are 12.6 V at 180 mA for the filament and +100 V at 12 mA for the plate.

CABLE is 54 in long with GR connector.

CAPACITOR-COUPLER HEAD is rated at 0.001 μ F, 600 V DC. Low frequency 3-dB point is 16 Hz.

P6032 PROBE, order 010-0108-00

Includes: capacitor-coupler head (010-0330-00); ground clip (013-0037-00); spring contact (214-0278-00); seven attenuator heads; center pin (214-0302-00); two solderable ground clips (344-0080-00); four indicator rings† (354-0196-00); four indicator rings† (354-0197-00); storage case (202-0136-00) instruction manual† (070-0327-01).

† not shown

OPTIONAL ACCESSORIES

Probe Tip to GR Adapter, order 017-0066-00

Probe Tip to BNC Adapter, order 013-0057-00

Part Number	Attenuator Head	Max Input Voltage*	Input Capacitance ($\pm 10\%$)
010-0350-00	10X	± 1.5 V	3.6 pF
010-0351-00	20X	± 3.0 V	2.6 pF
010-0352-00	50X	± 7.5 V	1.8 pF
010-0353-00	100X	± 15 V	1.5 pF
010-0354-00	200X	± 30 V	1.4 pF
010-0355-00	500X	± 75 V**	1.3 pF
010-0356-00	1000X	± 150 V**	1.3 pF

*Limited by linearity of cathode follower. This value may be exceeded by 50% for pulses without damage to probe components.

**Must be derated for continuous wave use. Peak to peak voltage derating is necessary at CW frequencies higher than 500 MHz for the 1000X attenuator head and 1000 MHz for the 500X attenuator head.

Attenuator Head	Max Input Voltage (peak to peak) (at 100% duty factor)			
	500 MHz	750 MHz	1000 MHz	1250 MHz
500X	150 V	150 V	150 V	125 V
1000X	300 V	200 V	150 V	125 V

INPUT RESISTANCE at DC of all attenuator heads is 10 megohms $\pm 2\%$.

Please refer to Terms and Shipment, General Information page.

P6034

DC-to-3.5 GHz
10X VOLTAGE PROBE

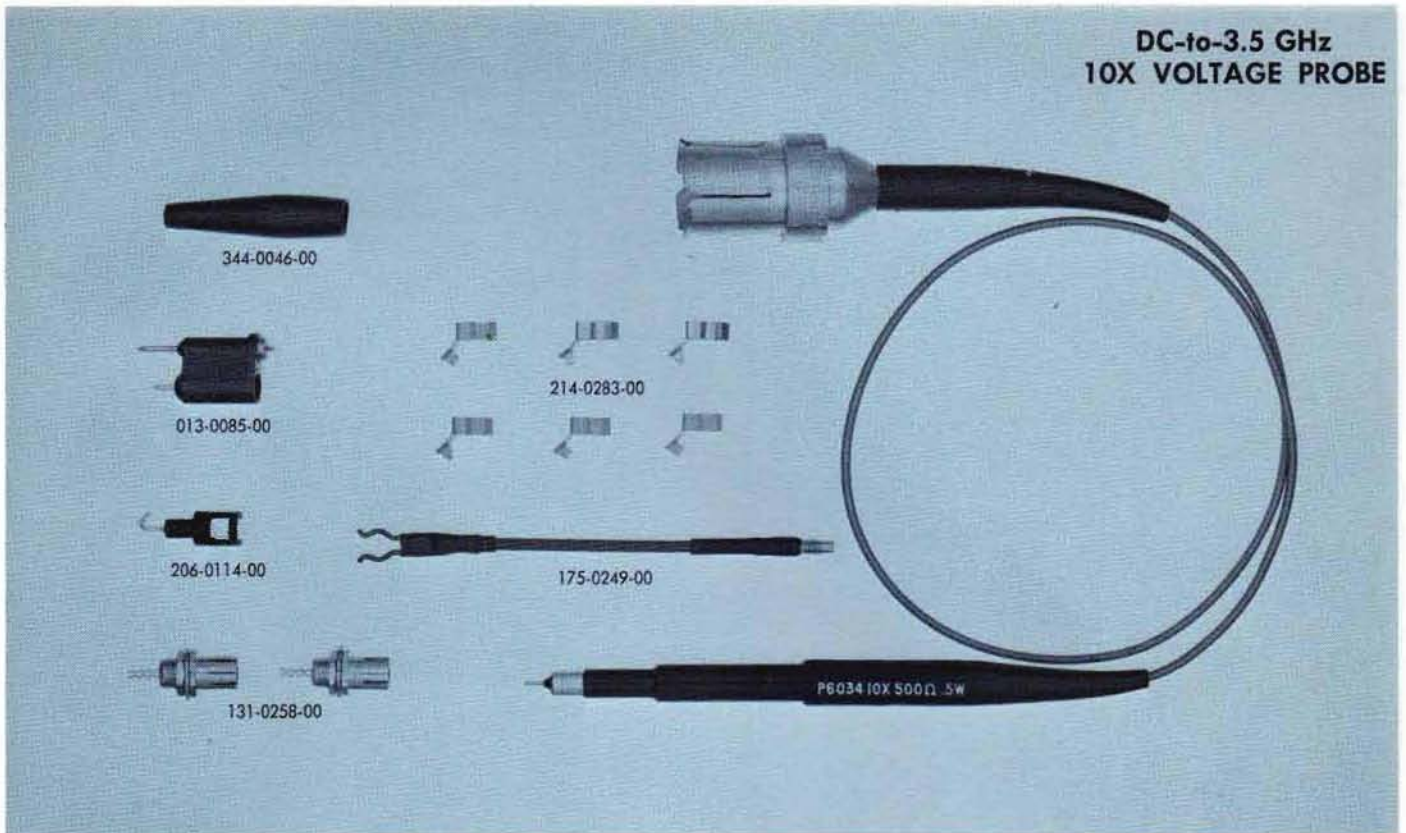

The P6034 low-capacitance, miniature probe is designed for use with Tektronix 50- Ω sampling units such as the Type 1S1, 1S2, 3S1, 3S2, 4S1 and 4S2A Sampling Plug-In Units. With the use of a 50- Ω termination, the P6034 can be used with wide-band, non-sampling oscilloscopes when an extremely low input capacitance is required.

ATTENUATION is 10X.

INPUT RESISTANCE is 500 ohms $\pm 1.5\%$, approximately 300 ohms at 1 GHz.

INPUT CAPACITANCE is 0.7 pF, DC to 100 MHz.

PROBE RISE TIME is less than 100 ps.

BANDWIDTH is DC to 3.5 GHz (3-dB down).

LOW FREQUENCY RESPONSE is approximately 70 kHz at 3-dB down, AC-coupled.

MAXIMUM RINGING AND OVERSHOOT is 2% using a 25-ohm source and coaxial probe ground.

VOLTAGE RATING is 16 V DC or 45 V peak to peak.*

CABLE is 18 inches long with GR connector.

P6034 PROBE, order 010-0110-00

Includes: hook tip (206-0114-00); six ground clips (214-0283-00); minigator clip (344-0046-00); two test jacks (131-0258-00); 2 1/2 inch ground lead (175-0249-00); bayonet-ground adapter (013-0085-00); instruction manual (070-0368-00).

OPTIONAL ACCESSORIES

50- Ω Termination, GR 874 to BNC, order 017-0083-00

Type VP-1 50- Ω Voltage Pickoff, order 017-0073-00

Probe Tip to GR Adapter, order 017-0076-00

Probe Tip to BNC Adapter, order 013-0084-00

*peak to peak voltage derating is necessary for CW frequencies higher than 800 MHz. At 1 GHz, the maximum allowable peak to peak voltage is 25 V.

Please refer to Terms and Shipment, General Information page.

P6035

DC-to-1.7 GHz 100X VOLTAGE PROBE

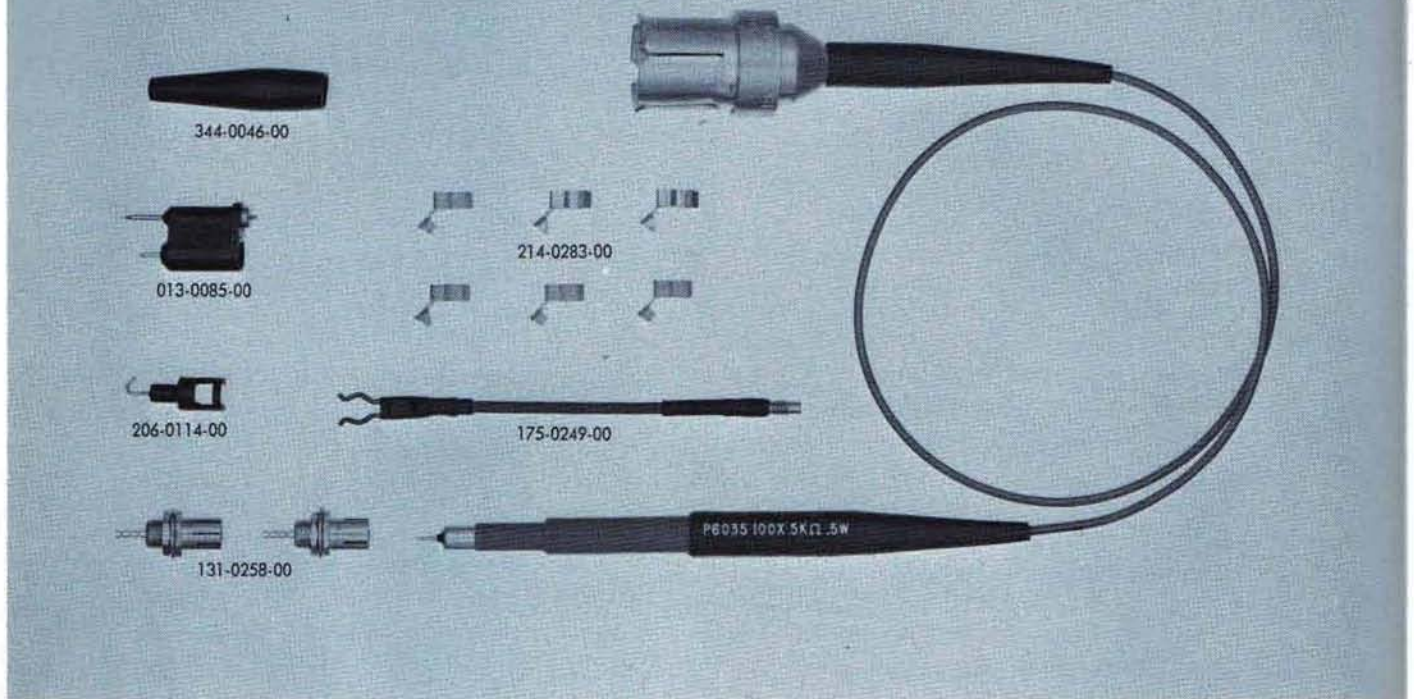

The P6035 low-capacitance, miniature probe is designed for use with Tektronix 50- Ω sampling units such as the Type 1S1, 1S2, 3S1, 3S2, 4S1 and 4S2A Sampling Plug-In Units. With the use of a 50- Ω termination, the P6035 can be used with wide-band, non-sampling oscilloscopes when an extremely low input capacitance is required.

ATTENUATION is 100X.

INPUT RESISTANCE is 5 kilohms $\pm 1.5\%$, approximately 1.5 k at 1 GHz.

INPUT CAPACITANCE is 0.6 pF, DC to 100 MHz.

PROBE RISETIME is less than 200 ps.

BANDWIDTH is DC to 1.7 GHz (3-dB down).

LOW FREQUENCY RESPONSE is approximately 6 kHz at 3-dB down, AC-coupled.

MAXIMUM RINGING AND OVERSHOOT is 2% using a 25-ohm source and coaxial probe ground.

VOLTAGE RATING is 50 V DC or 140 V peak to peak.*

CABLE is 18 inches long with GR connector.

P6035 PROBE, order 010-0111-00

Includes: hook tip (206-0114-00); six ground clips (214-0283-00); minigator clip (344-0046-00); two test jacks (131-0258-00); 2 1/2 inch ground lead (175-0249-00); bayonet-ground adapter (013-0085-00); instruction manual (070-0369-00).

OPTIONAL ACCESSORIES

50- Ω Termination, GR 874 to BNC, order 017-0083-00

Type VP-1 50- Ω Voltage Pickoff, order 017-0073-00

Probe Tip to GR Adapter, order 017-0076-00

Probe Tip to BNC Adapter, order 013-0084-00

*peak to peak voltage derating is necessary for CW frequencies higher than 500 MHz. At 1 GHz, the maximum allowable peak to peak voltage is 60 V.

Please refer to Terms and Shipment, General Information page.

P6038

DC-to-1 GHz
SAMPLING PROBE

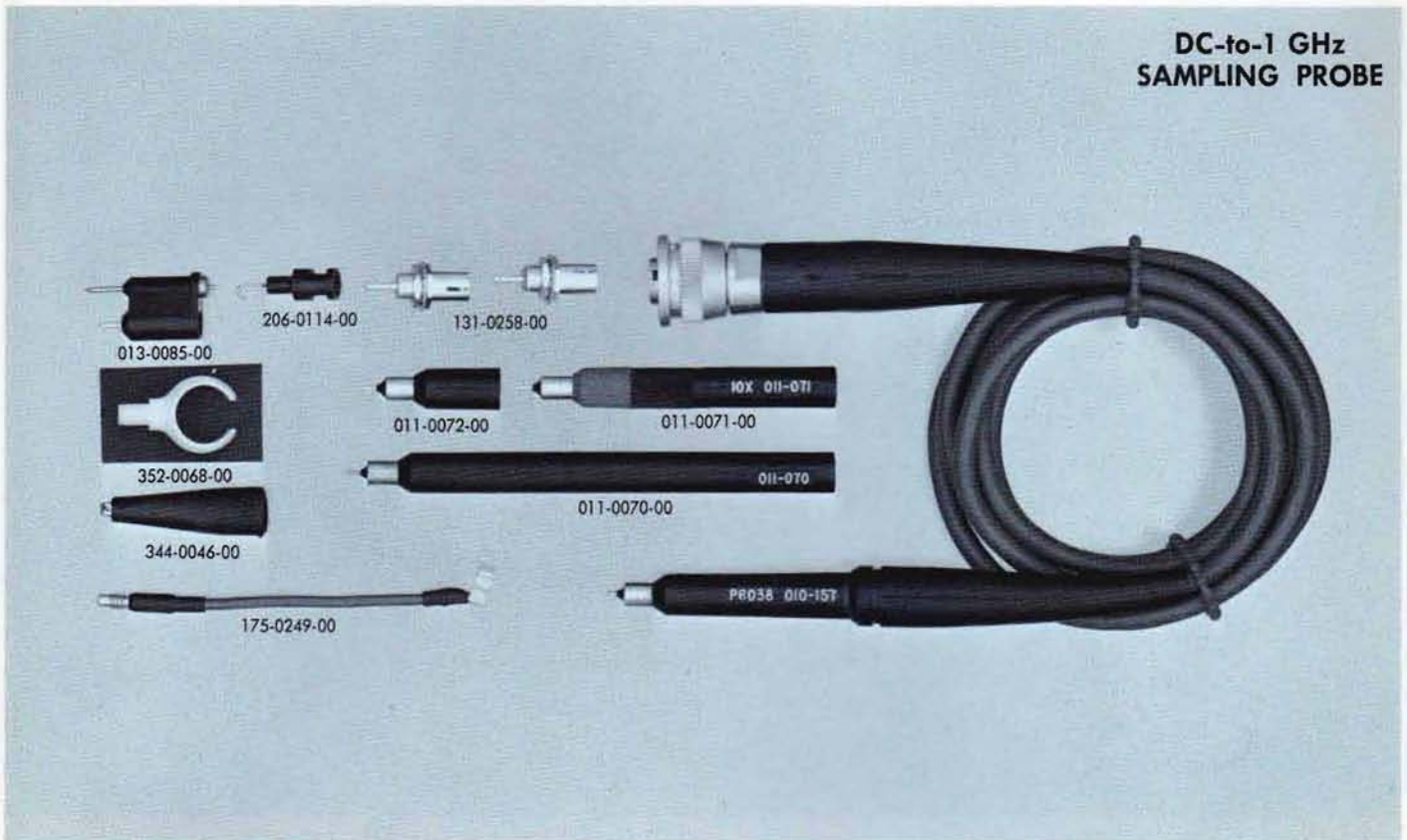

Specifically designed for use with the Type 3S3 and 4S3 Sampling Plug-Ins, the P6038 Probe features wide-band performance in the DC-to-1 GHz range.

Very small in size for ease of handling, the P6038 Probe contains sampling circuitry in the probe head, permitting low-noise, full-sensitivity measurements even when used with source impedances above 50 ohms.

Standard accessories supplied with the P6038 Probe include a 10X Attenuator, a Coupling Capacitor for blocking the DC component of the signal, and a non-attenuating Response Normalizer to assure the probe input is insensitive to source impedance variations.

PROBE ALONE:

ATTENUATION is 1X.

INPUT RESISTANCE is $100\text{ k}\Omega \pm 1\%$.

INPUT CAPACITANCE is $2\text{ pF} \pm 10\%$.

TYPICAL RISETIME with Type 3S3 or 4S3 Plug-In Unit and a 50-ohm source is 350 ps or less.

CABLE is approximately 4.5 ft with special 4-pin connector.

P6038 PROBE, order 010-0156-00

Includes: coupling capacitor (011-0072-00); 10X attenuator (011-0071-00); response normalizer (011-0070-00); two test-point jacks (131-0258-00); bayonet ground assembly (013-0085-00); hook tip (206-0114-00); 2½-inch ground lead (175-0249-00); probe holder (352-0068-00); carrying case (202-0123-00); minigator clip (344-0046-00); instruction manual (070-0400-00).

PROBE/ADAPTER CHARACTERISTICS		
	INPUT R	INPUT C
PROBE AND COUPLING CAPACITOR		$3.5\text{ pF} \pm 10\%$
PROBE AND 10X ATTENUATOR	$1\text{ M}\Omega \pm 1\%$	$1.8\text{ pF} \pm 10\%$
PROBE AND RESPONSE NORMALIZER	$100.3\text{ k}\Omega \pm 1\%$	$3.5\text{ pF} \pm 10\%$

OPTIONAL ACCESSORIES

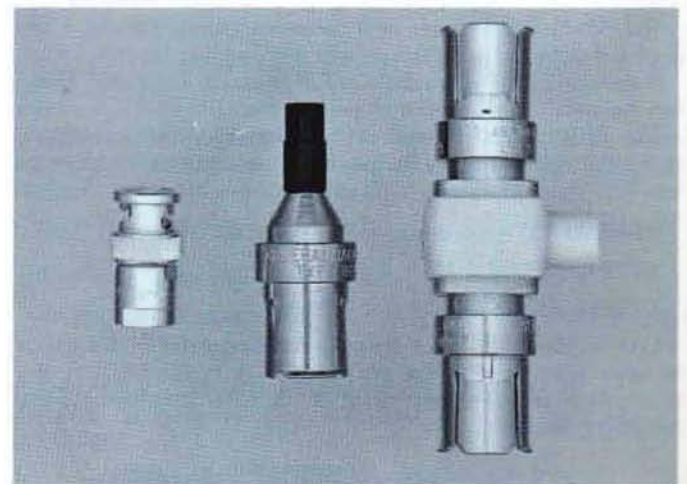

PROBE TIP-TO-BNC ADAPTER, order 013-0084-00

PROBE TIP-TO-GR ADAPTER, order 017-0076-00

VP-2 VOLTAGE PICKOFF "T", order 017-0077-00

P6040/CT1

35 kHz-to-1 GHz CURRENT PROBE

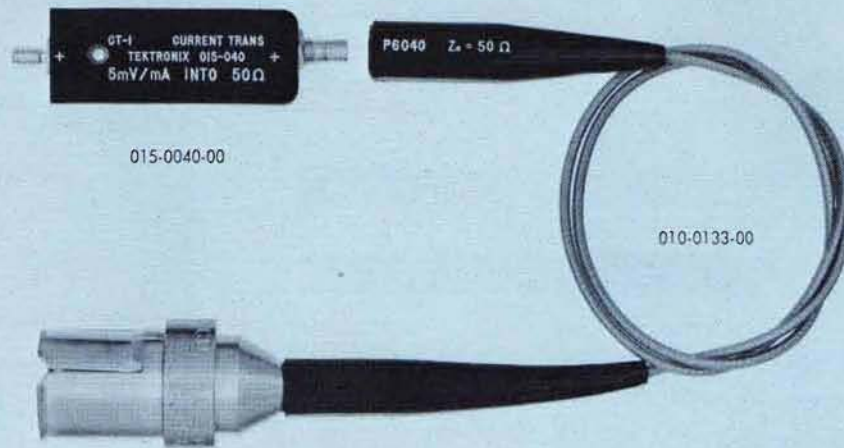

The P6040/CT-1 Current Probe is designed for use with Tektronix 50- Ω sampling units, such as the Type 1S1, 1S2, 3S1, 3S2, 4S1 and 4S2A Sampling Plug-In Units. With the use of a 50- Ω termination, the P6040/CT-1 can be used with wide-band, non-sampling oscilloscopes for making fast-risetime current measurements.

Several CT-1 current transformers may be placed throughout the circuit and monitored by one or more P6040 Probes. For a longer length probe, additional 50- Ω cable can be used in series with the probe.

P6040 PROBE

The P6040 Probe is an inter-connecting cable for the CT-1, used between the transformer and oscilloscope input.

If several CT-1 Transformers are in a circuit, the P6040 Probe can be used to monitor any one of them.

The P6040 can be used with other test-point connectors, such as Amphenol series 27 Sub-Minax or Sealectro Sub-Minature RF.

IMPEDANCE is 50 ohms.

ATTENUATION is 1X.

OUTPUT CONNECTOR is a GR type.

CABLE LENGTH is 18 inches. Additional 50- Ω cable can be used in series with the probe. RG8/U or RG58A/U is recommended for best preservation of the CT-1 Transformer high-frequency response.

CT-1 CURRENT TRANSFORMER

SENSITIVITY is 5 mV/mA into a 50-ohm load. Accuracy is better than $\pm 3\%$.

DECAY TIME CONSTANT is 5 μ s, approximated by 1% per 50 ns; limit, 1 μ s.

RISETIME is less than 350 ps.

FREQUENCY RESPONSE is 35 kHz to 1 GHz (30% down points).

INSERTION IMPEDANCE with a 50-ohm termination is 1 ohm shunted by approximately 5 μ H; 2 ohms shunted by approximately 5 μ H without a 50-ohm termination.

CAPACITIVE LOADING to a bare wire passing through the CT-1 transformer is typically 1.5 pF for #14 gauge, 0.6 pF for #20 gauge.

MAXIMUM VOLTAGE OF CIRCUIT UNDER TEST is 1000 V DC.

DIRECT CURRENT reduces the L/R time constant by a factor of 2 at 0.6 A.

PULSE CURRENT RATING is 100 A peak, with an amp-second product of 1 A- μ s. When the A-s product is exceeded, the core saturates reducing the CT-1 output to zero.

RMS CURRENT RATING is 500 mA maximum.

TEMPERATURE RATING is -25°C to $+65^{\circ}\text{C}$.

PHYSICAL DIMENSIONS are $\frac{3}{8}$ in x $\frac{9}{16}$ in x $1\frac{13}{16}$ in plus $\frac{1}{4}$ in x 6-32 mounting stud.

P6040/CT-1 CURRENT PROBE, order 015-0041-00

CT-1 CURRENT TRANSFORMER, order 015-0040-00

P6040 PROBE, order 010-0133-00

OPTIONAL ACCESSORY

50- Ω Termination, GR to BNC, order 017-0083-00

Please refer to Terms and Shipment, General Information page.

P6041/CT2

1.2 kHz-TO-200 MHz
CURRENT PROBE

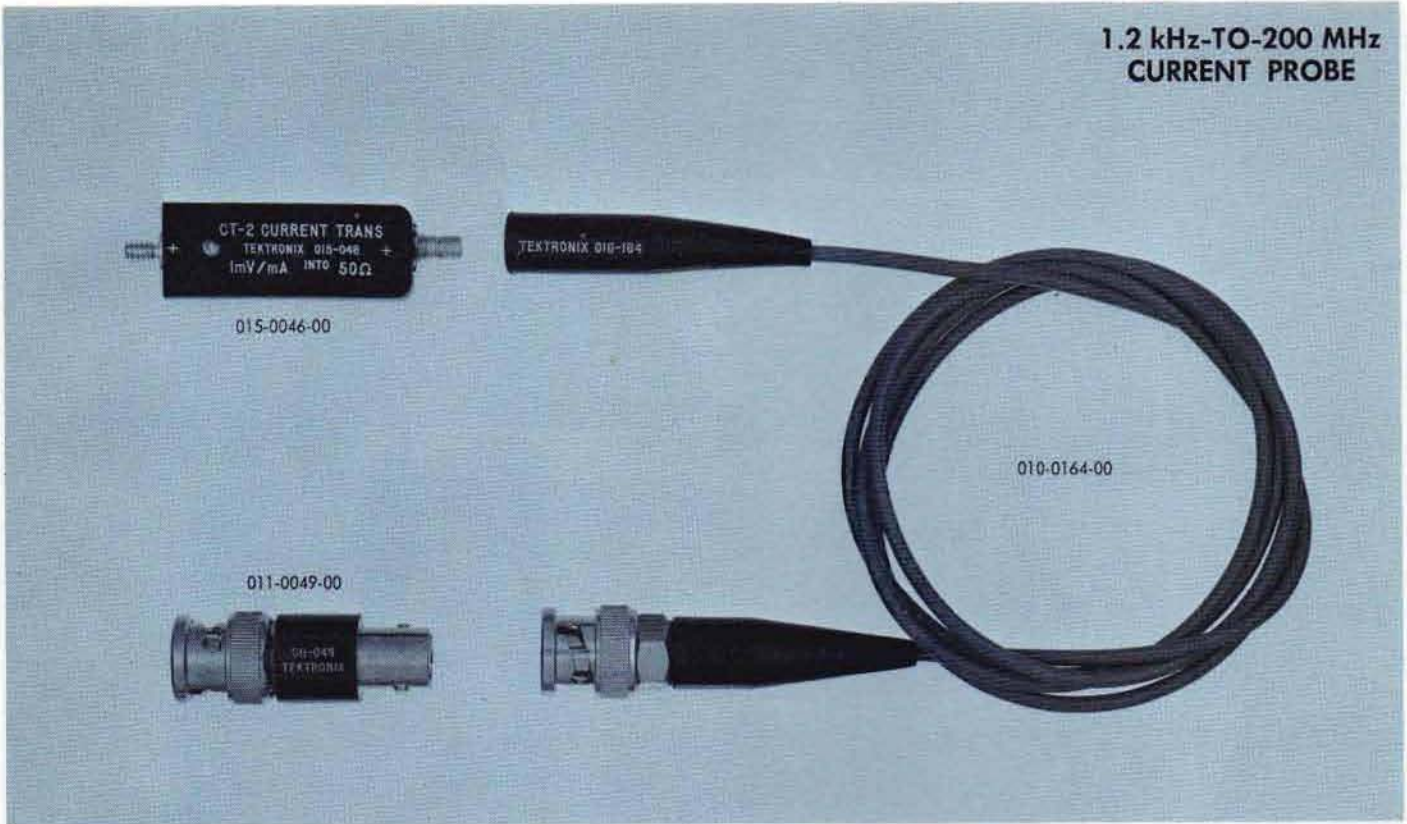

The P6041/CT-2 Current Probe is designed for use with Tektronix DC-to-150 MHz Oscilloscopes. A 50- Ω termination is used in conjunction with the P6041/CT-2 for terminating the probe at the input of the oscilloscope.

The insulated case of the CT-2 Current Transformer is convenient to use in applications where limited circuit space exists. Several CT-2 Transformers may be placed throughout the circuit and monitored by one or more P6041 Probes.

P6041 PROBE

The P6041 Probe serves as an interconnecting cable between the CT-2 Transformer and the oscilloscope input. A 50-ohm termination is used in conjunction with the P6041 for terminating the probe at the high impedance input of the oscilloscope used.

Although designed for use with the CT-2, the P6041 Probe can be used with other test-point connectors, such as Amphenol Series 27 Sub-Minax or Sealectro Sub-Miniature RF.

IMPEDANCE is 50 ohms.

ATTENUATION is 1X.

OUTPUT CONNECTOR is BNC type.

CABLE LENGTH is 42 in. Additional 50-ohm cable can be used in series with the probe. RG8/U or RG58A/U cable is recommended to preserve the high-frequency response.

CT-2 CURRENT TRANSFORMER

SENSITIVITY is 1 mV/mA into a 50-ohm load. Accuracy is better than $\pm 3\%$.

DECAY TIME CONSTANT is 125 μ s, approximated by 1% per 1.25 μ s; limit, 25 μ s.

RISETIME is approximately 0.5 ns.

FREQUENCY RESPONSE is 30% down at 1.2 kHz, 7% down at 200 MHz.

INSERTION IMPEDANCE with a 50-ohm termination is 0.04 ohms shunted by approximately 5 μ H; 0.08 ohms shunted by approximately 5 μ H without a 50-ohm termination.

CAPACITIVE LOADING to a bare wire passing through the CT-2 Transformer is typically 2.1 pF for #16 gauge, 0.7 pF for #22 gauge.

MAXIMUM VOLTAGE OF CIRCUIT UNDER TEST is 1000 V DC.

DIRECT CURRENT reduces the L/R time constant by a factor of 2 at 0.5 A.

PULSE CURRENT RATING is 100 A peak, with an amp-second product of 50 A- μ s. When the A-s product is exceeded, the core saturates reducing the CT-2 output to zero.

RMS CURRENT RATING is 2.5 A maximum.

TEMPERATURE RATING is -25° C to $+65^{\circ}$ C.

PHYSICAL DIMENSIONS are $\frac{3}{8}$ in \times $\frac{1}{16}$ in \times $1\frac{13}{16}$ in plus $\frac{1}{4}$ in \times 6-32 mounting stud.

P6041/CT-2 CURRENT PROBE, order 015-0047-00
Includes: 50- Ω termination (011-0049-00); instruction manual (070-0406-01).

CT-2 CURRENT TRANSFORMER, order 015-0046-00

P6041 PROBE, order 010-0164-00

50-OHM TERMINATION, order 011-0049-00

Please refer to Terms and Shipment, General Information page.

P6042

DC-TO-50 MHz
1 mA/DIV CURRENT PROBE

NEW



The new P6042 is a DC-to-50 MHz current probe designed for use with all Tektronix oscilloscopes. Utilizing a variation of the Hall effect, the P6042 offers new capabilities for making both high-frequency and DC current measurements. AC Signals with DC components can be displayed on the oscilloscope with true waveform presentation. The probe is particularly useful for evaluating the performance of semiconductor circuits where a wide range of parameters exist. Fast switching transients, low-frequency response, and DC level can all be displayed simultaneously.

The probe can also be used to measure the sums or differences of currents in separate wires. When the probe is clipped around two wires carrying current in the same direction, the sum is displayed. By reversing one of the wires, the difference is displayed. For increased sensitivity, several loops can be placed through the probe, increasing the sensitivity by the number of loops.

The P6042 consists of an amplifier with built-in power supply, 6-foot probe cable, and probe head. The probe is easy to use. Simply place the conductor* in the slot of the probe head and close the spring-loaded slide . . . no need to break the circuit under test. A warning light on the front panel of the amplifier indicates when the slide is in the unlocked position. A compartment is provided in the front panel for use in degaussing, and for convenient storage of the probe head when the system is not in use.

*up to 0.150 inch diameter.

CHARACTERISTICS

Probe and Amplifier

SENSITIVITY is 1 mA/div to 1 A/div in 10 calibrated steps, 1-2-5 sequence, accurate within 3% (with an oscilloscope deflection factor of 50 mV/div).

BANDWIDTH is DC to 50 MHz at 3-dB down.

RISETIME is 7 ns or less.

DYNAMIC RANGE is + and - 10 divisions of display.

NOISE (periodic and random deviation) is 0.5 mA or less, plus 0.2 or less major divisions of display. Random trace shift is 1.5 mA or less.

THERMAL DRIFT is 2 mA/°C or less, plus 0.2 or less major division of display per °C.

MAXIMUM INPUT CURRENT is 10 A (DC plus Peak AC).*

MAXIMUM VOLTAGE OF CIRCUIT UNDER TEST is 600 V (DC plus Peak AC).

OUTPUT IMPEDANCE is 50 Ω through a BNC-type connector. A 50- Ω termination is supplied with the probe for use with 1-megohm systems.

*Peak-to-peak current derating is necessary for CW frequencies higher than 2 MHz. At 50 MHz, the maximum allowable current is 2 A.

P6042

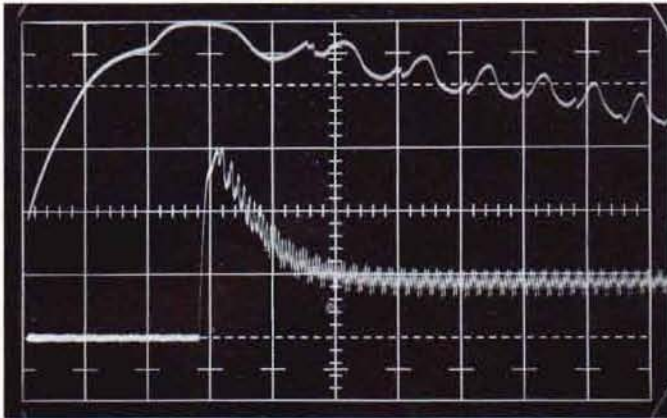

Double exposure photograph using the P6042 and a Type 547/1A5 Oscilloscope to display the current characteristics of a small DC motor. Lower display shows the zero current level, starting current, and running current. Current/div setting is 0.2 A/div with a sweep rate of 50 ms/cm. In the upper display, the sweep rate is increased to 5 ms/cm to show the current change as the commutator bars pass the brushes.

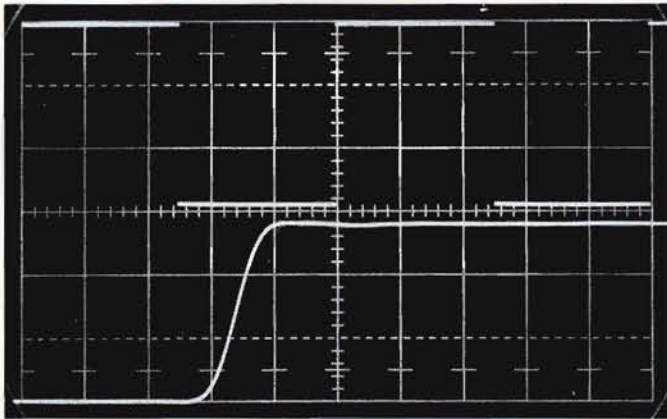

Upper display is a 60 Hz square wave demonstrating the DC response of the P6042. The lower display is the same waveform at 10 ns/div. Double exposure photograph.

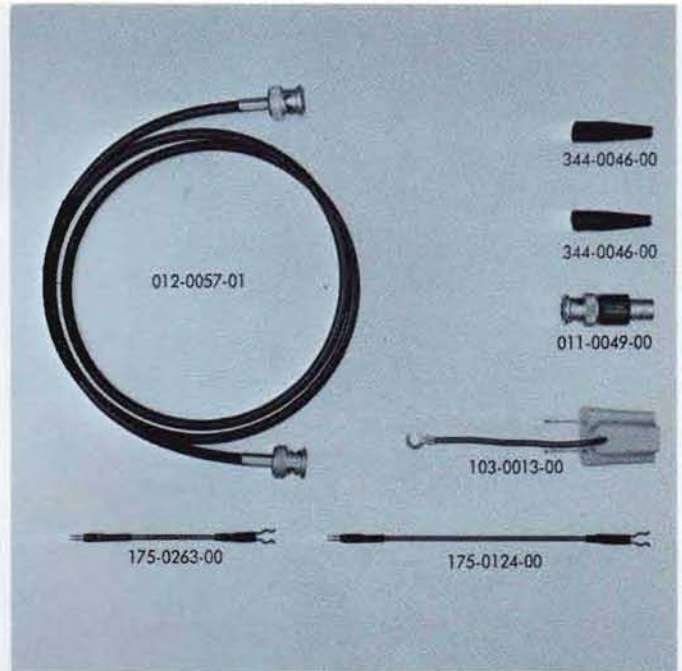

AMPLIFIER POWER REQUIREMENT is approximately 20 W, 50 Hz to 400 Hz. Quick-change line-voltage selector permits operation from 90 V to 136 V or 180 V to 272 V.

DIMENSIONS AND WEIGHT of the amplifier are 4½ in (11.4 cm) high by 7½ in (19.2 cm) wide by 9¾ in (24.8 cm) deep; 6½ lbs. (3.1 kg).

PROBE CABLE is 6 feet long, permanently connected between the probe head and amplifier.

P6042 DC CURRENT PROBE, order 010-0207-00

Includes: 50-Ω BNC cable (012-0057-01); 50-Ω BNC termination (011-0049-00); 3-inch ground lead (175-0263-00); 5-inch ground lead (175-0124-00); two alligator clips (344-0046-00); 3-wire to 2-wire adapter (103-0013-00); instruction manual (070-0629-00).

OPTIONAL ACCESSORY

BNC-to-GR Adapter, order 017-0063-00

Please refer to Terms and Shipment, General Information page.

P6045

DC-to-230 MHz 1X VOLTAGE PROBE



The P6045 FET Probe offers new capabilities for measuring small, high-frequency signals. Unlike many general-purpose probes which require built-in attenuation to reduce circuit loading, the P6045 utilizes a field effect transistor, resulting in reduced loading without sacrificing the gain of the measurement system.

This new DC-to-230 MHz probe can be used with conventional oscilloscopes (1-M Ω inputs) and 50- Ω sampling oscilloscopes. Its small size makes it easy to use, particularly for applications involving compact circuitry. The probe also features a DC-offset control for measuring very small AC signals with DC potentials up to one volt.

Accessories supplied with the probe include 10X and 100X attenuator heads and an AC-coupling capacitor. Optional accessories include a probe power supply, and a tunnel diode pulser for checking the response of the probe.

The Accessory Power Supply permits the P6045 to be used with all Tektronix conventional oscilloscopes and 50- Ω sampling oscilloscopes. It provides the power required to operate one P6045. The Type 454 oscilloscope provides two P6045 probe power connectors.

CHARACTERISTICS

PROBE GAIN is adjustable to 1X.

RISETIME is 1.5 ns or less.

ABERRATIONS are less than + and -3% when used with real-time oscilloscopes, or less than + and -4% when used with sampling oscilloscopes.

BANDWIDTH is DC to 230 MHz at 3-dB down. Low-frequency 3-dB point with AC-coupling capacitor is less than 16 Hz.

INPUT RESISTANCE is 10 megohms.

INPUT CAPACITANCE is approximately 5.5 pF.

OUTPUT LOAD IMPEDANCE is 50 Ω . A switch on the compensating amplifier provides internal 50- Ω termination, or the probe can be terminated externally. This switching provision allows the P6045 to be used with either 50-ohm or 1-megohm systems. The probe may require recompensation when the termination is changed. Compensation is adjusted at the factory for 1-megohm systems.

DC-OFFSET RANGE is ± 1 V, selected by variable front-panel control.

OUTPUT DYNAMIC RANGE is ± 0.5 V peak.

INPUT DYNAMIC RANGE is ± 0.5 V peak around a reference voltage which can be offset by 0 to ± 1 V DC.

NOISE is less than 0.4 mV over a bandwidth of DC to 8 MHz, less than 1.5 mV over a bandwidth of DC to 230 MHz.

MAXIMUM INPUT SURGE VOLTAGE is ± 100 V DC.

PROBE POWER REQUIREMENTS are +12.0 V, $\pm 1\%$ at approx 50 mA; -12.0 V, $\pm 1\%$ at approx 100 mA.

CABLE is 6 ft long. Output connector is locking BNC.

ACCESSORY POWER SUPPLY operates from 93 V to 140 V or 186 V to 280 V line.

P6045

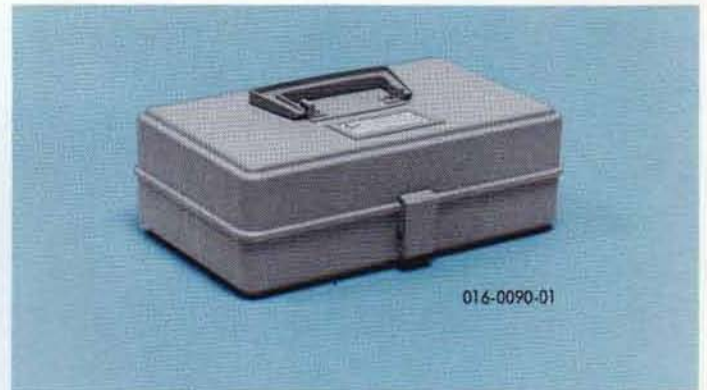
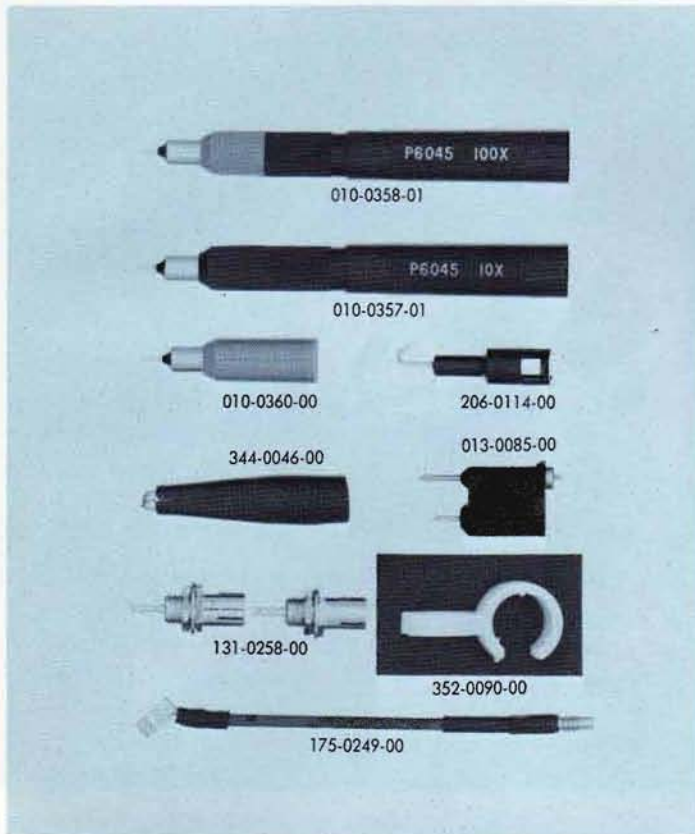

OPTIONAL ACCESSORIES



PROBE CHARACTERISTICS WITH ACCESSORY HEADS

	Max-Voltage Input (DC + Peak AC)	Attenuator Accuracy	Input C
10X Attenuator	±100 V	±3.5%	2.3 pF
100X Attenuator	±100 V	±3.5%	1.8 pF
AC-Coupling Capacitor	±200 V		6.0 pF

P6045 PROBE WITH ACCESSORY POWER SUPPLY,
order 010-0205-00

P6045 PROBE, order 010-0204-00

Includes: 10X attenuator head (010-0357-01); 100X attenuator head (010-0358-01); AC-coupling capacitor head (010-0360-00); 2½-in ground lead (175-0249-00); bayonet ground adapter (013-0085-00); hook tip (206-0114-00); alligator clip (344-0046-00); two test jacks (131-0258-00); probe holder (352-0090-00); carrying case (016-0090-01); two instruction manuals (070-0597-00).

POWER SUPPLY, order 015-0073-00

Power Supply includes: power cord (161-0025-00); 2 to 3-wire adapter (103-0013-00); instruction manual (070-0636-00).

The tunnel-diode pulser is used to adjust the P6045 FET Probe for optimum response. The pulser is designed to be driven by the 100 V output of the oscilloscope calibrator. Risetime of the probe pulser is less than 0.5 ns.

Probe Pulser, order 015-0088-00

Probe Tip to GR Adapter, order 017-0076-00

Probe Tip to BNC Adapter, order 013-0084-00

Please refer to Terms and Shipment, General Information page.

P6046

DIFFERENTIAL PROBE AND AMPLIFIER

NEW



● 1,000:1 CMRR at 50 MHz

The P6046 Differential Probe and P6046 Amplifier Unit provide new measurement capabilities when used with all Tektronix oscilloscopes. With this new probe system, the differential-signal processing takes place in the probe itself, resulting in high common-mode signal rejection at higher frequencies. Differential probe-tip signal processing minimizes the measurement errors caused by differences in probes, cable lengths, and input attenuators. In addition, the wide-band capability of the P6046 Probe and Amplifier provides DC-to-100 MHz single-ended measurements.

The probe circuitry utilizes 13 semiconductors including dual FET's for the balanced input. A switch on the probe selects AC or DC input coupling. Accessories include a plug-on 10X attenuator for extending the differential input voltage range, and a ground tip for applications requiring single-ended input. Unique swivel tips provide variable spacing to accommodate varying distance between test points.

The P6046 Amplifier mounts conveniently on the side of the oscilloscope and features a calibrated 1-mV/div to 200-mV/div (2 V/div with 10X attenuator) deflection factor (oscilloscope deflection factor set at 10 mV/div). The output impedance of the amplifier is 50 Ω . A 50- Ω termination is supplied with the amplifier for use with 1-M Ω systems.

The P6046 Differential Probe may be used with the Type 1A5 Differential Amplifier with Tektronix Type 530, 540, 550, and 580-Series Oscilloscopes. The P6046 Probe extends the differential measurement capabilities of the Type 1A5 to 50 MHz. (CMRR is 1,000:1 at 50 MHz). Probe power is obtained directly from the Type 1A5.



CHARACTERISTICS

Probe and Amplifier

DEFLECTION FACTOR is 1 mV/div to 200 mV/div in 8 calibrated steps, 1-2-5 sequence, accurate within 3% (with an oscilloscope deflection factor of 10 mV/div).

BANDWIDTH is DC-to-100 MHz at 3-dB down.

RISETIME is 3.5 ns or less.

COMMON-MODE REJECTION RATIOS with deflection factors of 1 mV/div to 20 mV/div are at least 10,000:1 at 50 kHz, 5,000:1 at 1 MHz and 1,000:1 from 10 MHz to 50 MHz.

COMMON-MODE LINEAR DYNAMIC RANGE is ± 5 V (DC + peak AC), ± 50 V with 10X attenuator.

INPUT RC is 1 M Ω paralleled by approximately 10 pF.

INPUT COUPLING is AC or DC, selected by a switch on the probe. Low-frequency response AC-coupled is 3-dB down at 20 Hz, 2 Hz with 10X attenuator.

NOISE (periodic and random deviation) referred to the input is 280 μ V or less.

MAXIMUM INPUT VOLTAGE is ± 25 V (DC + peak AC), ± 250 V with 10X attenuator.

OUTPUT IMPEDANCE is 50 Ω through a BNC-type connector. A 50- Ω termination is supplied with the amplifier for use with 1-megohm systems.

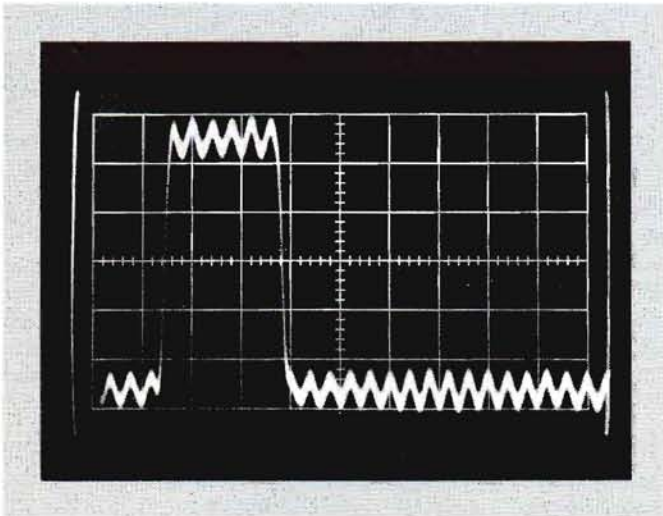

The photograph shows a 5-mV pulse with a 1-volt, 50-MHz common-mode signal (Vertical - 1 mV/div; Horizontal - 50 ns/div). The measurement was made using a P6046 Probe and Amplifier and a Type 454 Oscilloscope. It demonstrates the $\geq 1,000:1$ common-mode rejection ratio of the P6046 Probe and Amplifier.

LINEAR OUTPUT is ± 10 div with the oscilloscope set at 10 mV/div.

PROBE CABLE is 6 feet long, terminated with a special nine-pin connector.

AMPLIFIER POWER REQUIREMENTS are 10 watts maximum, 50 to 400 Hz. Factory wired for 105 V to 125 V (117 V nominal) operation. Transformer taps permit operation at 210 V to 250 V (234 V nominal). Instrument can be ordered factory wired for 210 V to 250 V operation.

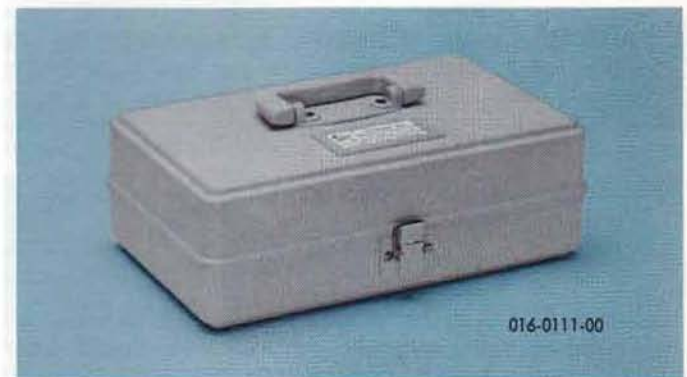
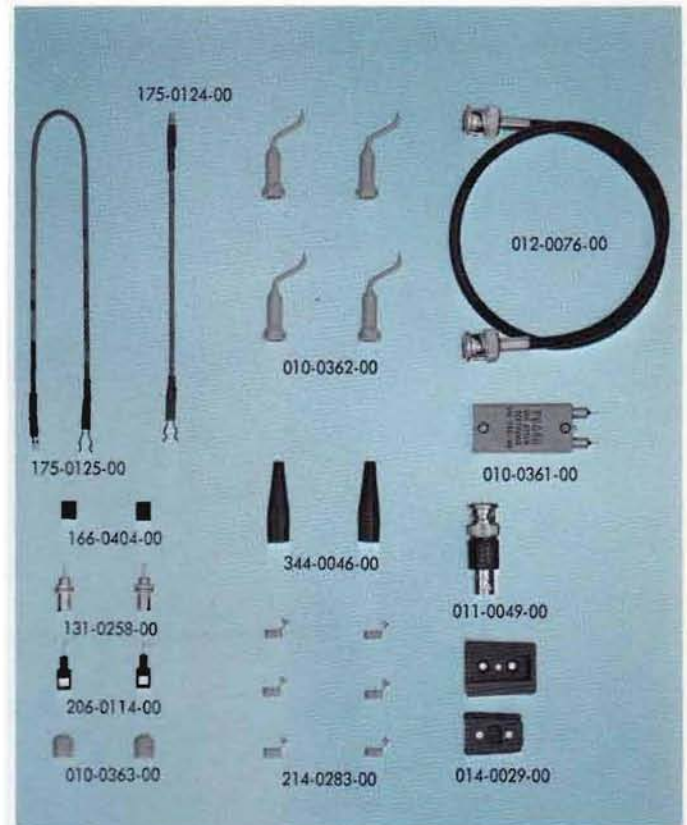

P6046 Probe and Amplifier, order 010-0232-00
Includes: P6046 Probe Package (010-0213-00); Amplifier for P6046 and Power Supply (015-0106-00).

Amplifier for P6046, order 015-0106-00
Includes: Amplifier for P6046 and Power Supply; hanger assembly (014-0029-00); 50- Ω cable (012-0076-00); 50- Ω termination (011-0049-00); instruction manual (070-0756-00).

P6046 Probe, order 010-0213-00
Includes: P6046 Probe (010-0214-00); dual 10X attenuator head (010-0361-00); four swivel tip assemblies (010-0362-00); two ground tips (010-0363-00); 5-inch ground lead (175-0124-00); 12-inch ground lead (175-0125-00); two alligator clips (344-0046-00); two hook tips (206-0114-00); two test jacks (131-0258-00); two insulating tubes (166-0404-00); six ground clips (214-0283-00); carrying case (016-0111-00); instruction manual (070-0745-00).

Please refer to Terms and Shipment, General Information page.

P6047

DC-to-290 MHz 10X VOLTAGE PROBE

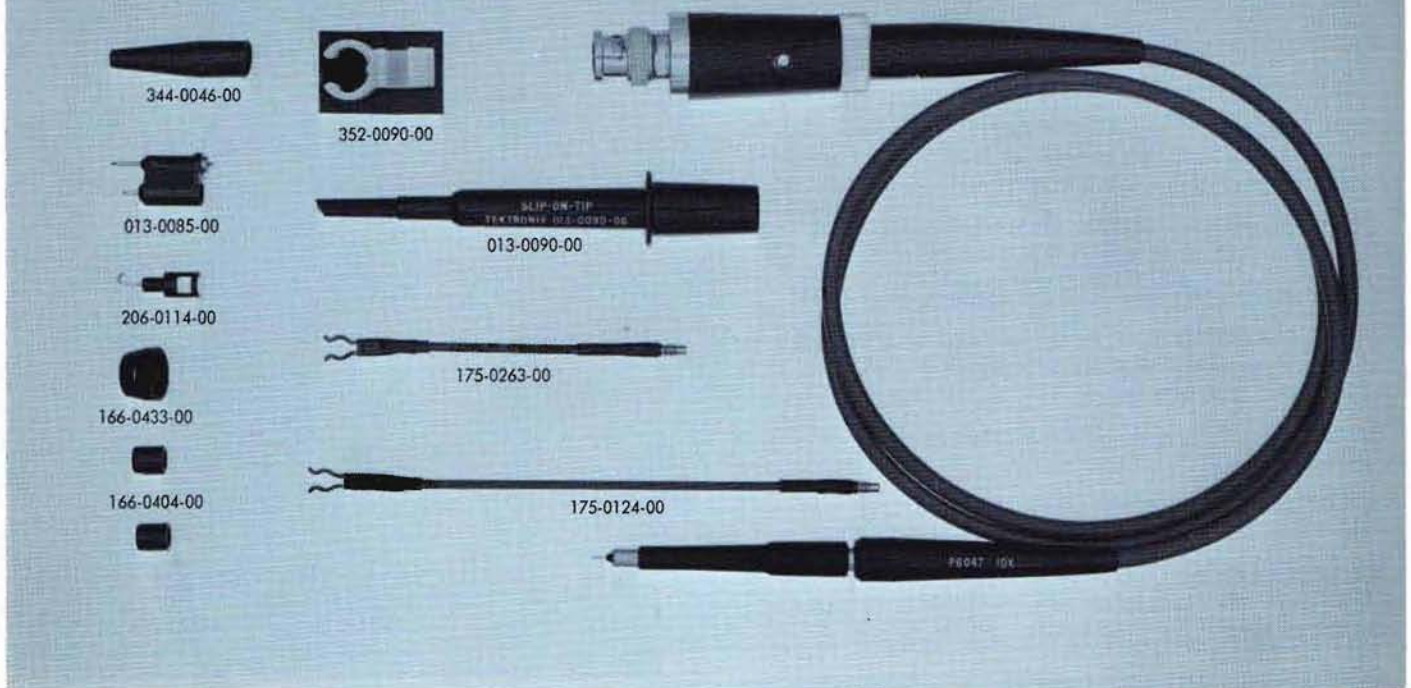

The P6047 is a general-purpose probe designed for use with the Type 454 Portable Oscilloscope or the Type 647A Oscilloscope with Type 10A2A Plug-In Unit. It can also be compensated for use with other instruments that have an input capacitance of 15 to 20 pF, and input resistance of 1 M Ω .

The P6047 offers a new level of performance in passive probe design. Its small size makes it easy to use, particularly for applications involving compact circuitry. In addition to the standard 3.5-foot cable length, the probe is available with a 6-foot cable at no additional cost.

ATTENUATION is 10X.

INPUT RESISTANCE is 10 megohms.

INPUT CAPACITANCE for the standard length probe is approximately 10 pF when used with instruments having a 15 to 20 pF input capacitance; 12 pF for the 6-foot version. The input capacitance of both probes decreases to less than 7 pF above 100 MHz.

PROBE RISETIME is 1.2 ns \dagger or less.

TYPICAL RISETIME of probe and Type 454 Oscilloscope is 2.4 ns \dagger . Typical risetime with Type 10A2A is 3.5 ns \dagger .

ABERRATIONS are 3% or less.

VOLTAGE RATING is 500 V DC, AC peak, or DC and AC peak combined.*

STANDARD CABLE is 3.5 ft long, terminated with a BNC connector.

P6047 3.5 FT PROBE, order 010-0211-00

P6047 6 FT PROBE, order 010-0217-00

Includes: hook tip (206-0114-00); retractable-hook tip (013-0090-00); bayonet-ground adapter (013-0085-00); minigator clip (344-0046-00); probe holder (352-0090-00); 3-inch ground lead (175-0263-00); 5-inch ground lead (175-0124-00); two insulating tubes (166-0404-00); insulating sleeve (166-0433-00); instruction manual (070-0628-01).

OPTIONAL ACCESSORIES

Probe Tip to GR Adapter, order 017-0076-00

Probe Tip to BNC Adapter, order 013-0084-00

\dagger Due to the fast-rise characteristics of this probe, the input capacitance and generator source impedance must be considered in determining the risetime of the system. Risetimes listed are at a temperature of 25°C.

*peak voltage derating is necessary for CW frequencies higher than 4.5 MHz. At 10 MHz, the maximum allowable peak voltage is 200 V; 23 V at 100 MHz, 18 V at 150 MHz.

Please refer to Terms and Shipment, General Information page.

PROBE ACCESSORIES

PROBE TIPS AND ADAPTERS

The following tips and adapters can be used on all Tektronix Probes that accept a #6-32 screw-on tip including the P6006, P6007, P6008, P6009, P6027 and P6028 Probes.

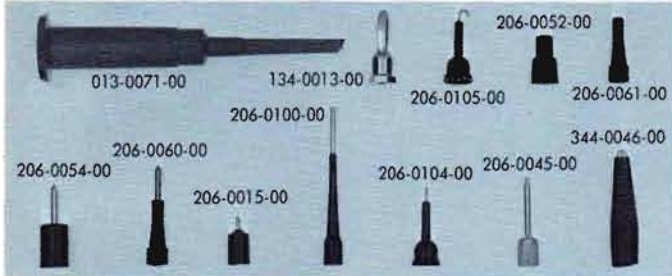

Calibration Tip (0.063 in dia)	206-0100-00
Straight Tip (0.082 in dia)	206-0045-00
Straight Tip (0.086 in dia)	206-0054-00
Long Straight Tip (0.032 in dia)	206-0104-00
Spring Tip (0.065 in dia)	206-0060-00
Spring Tip (accepts 0.065 in pin or plug)	206-0061-00
Recessed Tip (accepts 0.065 in recessed pin or plug)	206-0052-00
Short Straight Tip (0.055 in dia)	206-0015-00
Banana Tip	134-0013-00
Minigator Tip	344-0046-00
Hook Tip	206-0105-00
Retractable Hook Tip (for P6006, P6007, P6008, P6009, P6023, P6027, P6028)	013-0071-00



Probe Tip to BNC Adapter (for P6006, P6007, P6008, P6009)	013-0054-00
Probe Tip to BNC Adapter (for P6023, P6027, P6028)	013-0056-00
Bayonet Ground Assembly (for P6006, P6007, P6008, P6009)	013-0052-00

PROBE GROUND LEADS

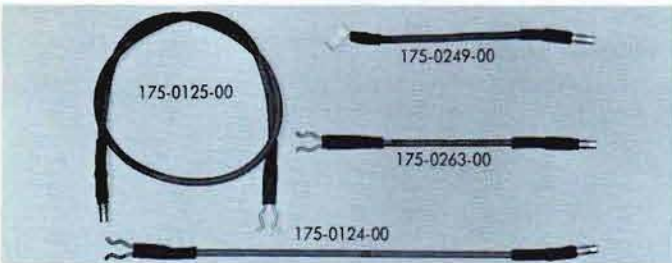

The following Ground Leads have a 6-32 thread size.

DESCRIPTION	PART NUMBER
3-inch Ground Lead	175-0263-00
5-inch Ground Lead	175-0124-00
12-inch Ground Lead	175-0125-00
2 1/2-inch Ground Lead (for P6034, P6035, P6038, P6045)	175-0249-00

MINIATURE PROBE TIPS AND ADAPTERS

The following tips and adapters are designed for use with Tektronix Miniature Probes that accept a slip-on tip including the P6010, P6011, P6012 and P6047 Probes.

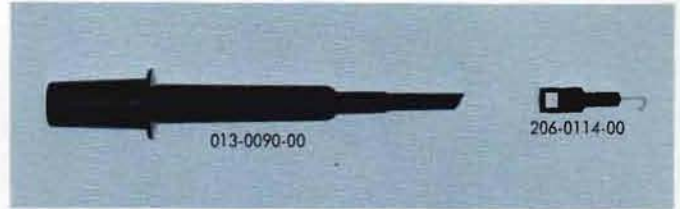

Hook Tip	206-0114-00
Retractable Hook Tip (for P6010, P6011, P6012, P6047)	013-0090-00



Miniature Probe to 6-32 Adapter (adapts miniature probe for use with all #6-32 screw-on tips)	103-0051-00
Probe Tip to GR Adapter	017-0076-00
Probe Tip to BNC Adapter	013-0084-00
Bayonet Ground Assembly	013-0085-00
Chassis Mount Test Jack	131-0258-00

IDENTIFICATION TAGS



Probe identification tags for multi-probe applications help locate correlating probe ends quickly. One package contains 2 each of 10 colors.

For 1/8 in dia cable, order 334-0798-00
For 3/16 in dia cable, order 334-0798-01

PROBE GROUNDING ADAPTER

PROBE GROUNDING ADAPTER for Tektronix 10X probes provides a convenient method of establishing the vertical position of the oscilloscope trace in relation to zero volts input at the probe tip. The adapter eliminates the need for moving the probe tip from the signal source to ground.

Push-button operation of the Adapter disconnects the oscilloscope input from the probe and, at the same time, connects the input to ground through a parallel combination of a 9.1 megohm resistor and a 0.03 μF capacitor.

The Probe Grounding Adapter adds 7.5 pF to the input capacitance of the plug-in or oscilloscope. Readjustment of the probe is necessary for proper squarewave response.
With BNC connectors, order 015-0048-00
With UHF connectors, order 015-0044-00

ACCESSORIES WITH BNC CONNECTORS

ATTENUATORS—TERMINATIONS



DESCRIPTION	PART NUMBER
50-Ω termination	011-0049-00
50-Ω 2:1 attenuator	011-0069-00
50-Ω 2.5:1 attenuator	011-0076-00
50-Ω 5:1 attenuator	011-0060-00
50-Ω 10:1 attenuator	011-0059-00
50-Ω to 75-Ω min loss attenuator	011-0057-00
50 Ω to 93-Ω min loss attenuator	011-0058-00
75-Ω termination	011-0055-00
75-Ω 10:1 attenuator	011-0061-00
93-Ω termination	011-0056-00
93-Ω 10:1 attenuator	011-0062-00
170-Ω termination (UHF to BNC)	011-0063-00
600-Ω termination	011-0092-00

Characteristics

Accuracy of Indicated Attenuation Ratio is $\pm 2\%$ at DC; $\pm 3\%$ at 100 MHz.

Voltage Standing Wave Ratio (VSWR) is less than 1.1 up to 100 MHz.

Power Rating is $\frac{1}{2}$ watt.

Output to Input Voltage Ratios for Minimum-Loss Attenuators when properly terminated is:

Connection	E_{out}/E_{in}	Connection	E_{out}/E_{in}
50 Ω → 75 Ω	0.63	50 Ω → 125 Ω	0.56
75 Ω → 50 Ω	0.42	125 Ω → 50 Ω	0.23
50 Ω → 93 Ω	0.59	50 Ω → 170 Ω	0.54
93 Ω → 50 Ω	0.32	170 Ω → 50 Ω	0.16

CABLES



Coaxial, 50 Ω, 18 in, order 012-0076-00
 Coaxial, 50 Ω, 42 in, order 012-0057-01
 Coaxial, 75 Ω, 42 in, order 012-0074-00
 Coaxial, 93 Ω, 42 in, order 012-0075-00

ADAPTERS



DESCRIPTION	PART NUMBER
BNC Male to UHF Female	103-0032-00
BNC Male to GR	017-0064-00
BNC Male to N Female	103-0058-00
BNC Male to Binding Post	103-0033-00
BNC Male to Dual Binding Post	103-0035-00

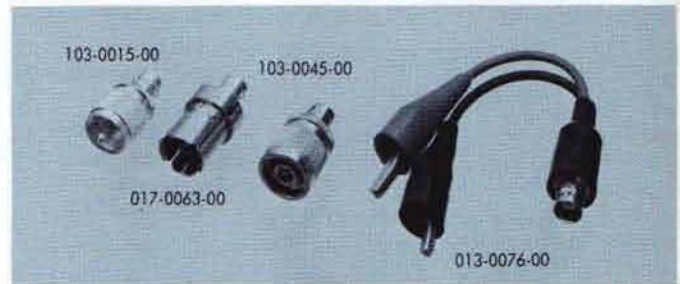

DESCRIPTION	PART NUMBER
BNC Female to UHF Male	103-0015-00
BNC Female to GR	017-0063-00
BNC Female to N Male	103-0045-00
BNC Female to clip leads	013-0076-00



DESCRIPTION	PART NUMBER
BNC Female to BNC Female	103-0028-00
BNC Male to BNC Male	103-0029-00
BNC T Male to 2 Female	103-0030-00
BNC Elbow Male to Female	103-0031-00



Accessory housing without electrical components is useful for applications requiring special circuitry.
 Order 011-0081-00

ACCESSORIES WITH UHF CONNECTORS

ATTENUATORS—TERMINATIONS

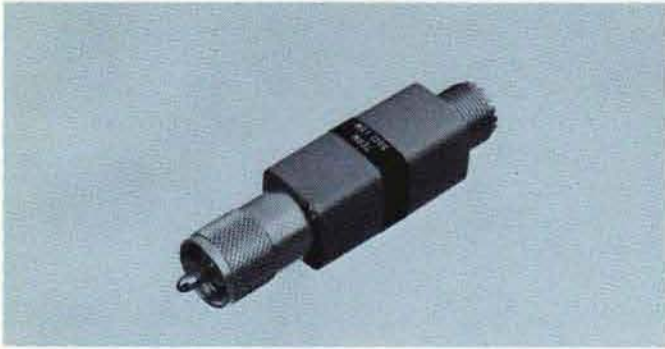

DESCRIPTION	PART NUMBER
50-Ω termination	011-0045-00
50-Ω 5:1 attenuator	011-0032-00
50-Ω 10:1 attenuator	011-0031-00
50-Ω to 75-Ω min loss attenuator	011-0041-00
50-Ω to 93-Ω min loss attenuator	011-0042-00
50-Ω to 170-Ω min loss attenuator	011-0043-00
75-Ω termination	011-0046-00
75-Ω 5:1 attenuator	011-0034-00
75-Ω 10:1 attenuator	011-0033-00
93-Ω termination	011-0047-00
93-Ω 5:1 attenuator	011-0036-00
93-Ω 10:1 attenuator	011-0035-00
170-Ω termination	011-0048-00

CHARACTERISTICS

Accuracy of Indicated Attenuation Ratio is $\pm 2\%$ at DC; $\pm 3\%$ at 100 MHz.
 Voltage Standing Wave Ratio (VSWR) is less than 1.2 up to 100 MHz.
 Power Rating is 1.5 watts.
 Output to Input Voltage Ratios for Minimum-Loss Attenuators when properly terminated are as follows:

Connection	E_{out}/E_{in}	Connection	E_{out}/E_{in}
50 Ω → 75 Ω	0.63	50 Ω → 125 Ω	0.56
75 Ω → 50 Ω	0.42	125 Ω → 50 Ω	0.23
50 Ω → 93 Ω	0.59	50 Ω → 170 Ω	0.54
93 Ω → 50 Ω	0.32	170 Ω → 50 Ω	0.16

CABLES



Coaxial, 50-ohm, 42-in, order 012-0001-00
 Coaxial, 75-ohm, 42 in, order 012-0083-00
 Coaxial, 93-ohm, 42 in, order 012-0003-00
 Coaxial, 170-ohm, 42 in, order 012-0006-00

ADAPTERS



DESCRIPTION	PART NUMBER
UHF Male to BNC Female	103-0015-00
UHF Male to GR	017-0023-00
UHF Male to N Female	103-0059-00
UHF Male to binding post	013-0004-00
UHF Male to binding post with gnd	013-0009-00



UHF Female to BNC Male	103-0032-00
UHF Female to GR	017-0022-00
UHF Female to N Male	103-0044-00
UHF Female to clip leads	013-0003-00



UHF Female to UHF Female	103-0025-00
UHF T Male to 2 Female	103-0026-00
UHF Elbow Male to Female	103-0027-00



Accessory Housing without electrical components, useful for applications requiring special circuitry.
 Order 011-0080-00

ACCESSORIES WITH GR CONNECTORS

ATTENUATORS—TERMINATIONS

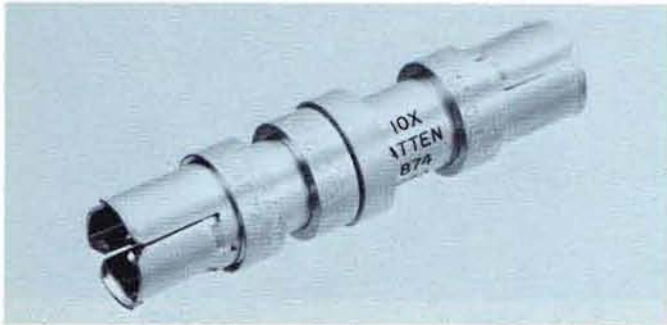

DESCRIPTION	PART NUMBER
50-Ω termination, thru-line (GR to BNC Male)	017-0083-00
50-Ω termination, end-line	017-0081-00
50-Ω 2:1 attenuator	017-0080-00
50-Ω 5:1 attenuator	017-0079-00
50-Ω 10:1 attenuator	017-0078-00
50-Ω to 125-Ω min loss	017-0052-00

CHARACTERISTICS

Accuracy of indicated attenuation ratio is $\pm 2\%$ at DC, $\pm 3\%$ at 1 GHz. Voltage standing wave ratio (VSWR) is less than 1.1 up to 1 GHz. Power Rating is 1 watt.

50-OHM CABLES



DESCRIPTION	PART NUMBER
Coaxial 1 ns Type RG58C/U*	017-0503-00
Coaxial 2 ns Type RG58C/U	017-0505-00
Coaxial 5 ns Type RG213/U	017-0502-00
Coaxial 5 ns Type RG58C/U	017-0512-00
Coaxial 10 ns Type RG58C/U	017-0501-00
Coaxial 20 ns Type RG213/U	017-0504-00

*Connector on one end only.

ADAPTERS



DESCRIPTION	PART NUMBER
GR to BNC Male	017-0064-00
GR to BNC Female	017-0063-00
GR to UHF Male	017-0023-00
GR to UHF Female	017-0022-00



GR to N Male	017-0021-00
GR to N Female	017-0062-00
GR to C Male	017-0027-00
GR to C Female	017-0065-00



GR T	017-0069-00
GR Elbow	017-0070-00



GR Insertion Unit	017-0030-00
-------------------	-------------

ACCESSORIES WITH GR CONNECTORS

50-OHM POWER DIVIDER

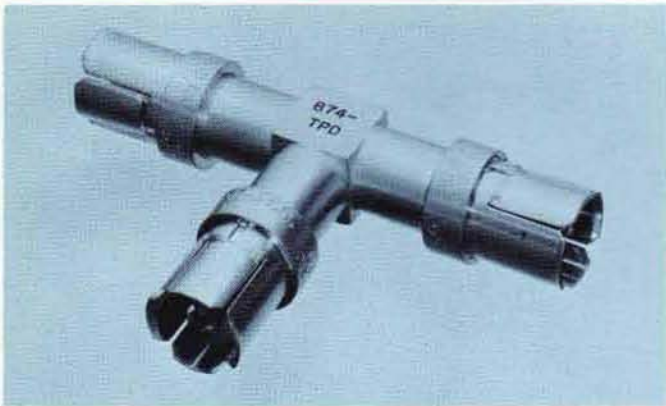

This coaxial tee has a 16.67-ohm resistor in each leg, connected so that the tee looks like 50-ohm if two legs are terminated in 50 ohm. It is designed for use in broad-band 50- Ω systems where the mismatch introduced by ordinary "Tee" connectors is undesirable. It is especially useful in a time-domain reflectometer set-up where test line, pulser, and oscilloscope must be coupled with a minimum of reflection-producing discontinuities.

Order 017-0082-00

COUPLING CAPACITOR



The coupling capacitor is a short length of coaxial line having a disk capacitor (4700 pF) in series with the inner connector. High frequencies are transmitted with small reflections, but DC and low frequencies are blocked. Voltage rating is 500 V.

Order 017-0028-00

50-OHM AIR LINE



The 20-cm 50- Ω air line is useful as a time-delay device and as an absolute impedance in a time-domain reflectometer system. The characteristic impedance is 50 Ω \pm 0.4%. Time delay is 0.667 ns \pm 0.4%.

Order 017-0084-00

50-OHM VOLTAGE PICKOFF "T"



The 50-ohm "T" type pickoff allows signal pickoff from a closed 50-ohm system with minimum disturbance of the system's characteristics.

TYPE VP-1 is designed for use with the P6034 or P6035 Miniature Passive Probes. The reflection coefficient of the VP-1 alone is approximately 3%. With the P6034 or P6035 inserted, it is typically 2%. The resistive reflection of the VP-1 is 1/2% when used with the P6035, 5% when used with the P6034.

Order 017-0073-00

TYPE VP-2 is used in conjunction with the P6038 Direct Sampling Probe. The reflection coefficient without the P6038 Probe is approximately 4%. With the probe inserted it is typically 6%. All accessory heads supplied with the P6038 Probe can be used with the VP-2.

Order 017-0077-00

CT-3 SIGNAL PICKOFF

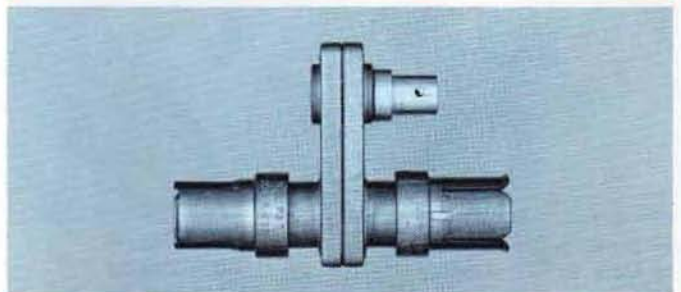

Designed for use with high-frequency oscilloscopes, the CT-3 Pickoff provides a convenient means of picking off a signal in a 50-ohm system. Used with any of the Tektronix sampling instruments, the CT-3 provides the link for use as a trigger source.

SENSITIVITY is 10% of the voltage under test, into a 50-ohm load.

DECAY TIME CONSTANT is 4.5 μ s at 0 DC current.

RISETIME is less than 0.4 ns.

FREQUENCY RESPONSE is 50 kHz to 875 MHz at 0 DC current.

INSERTION IMPEDANCE with a 50-ohm termination is 1 ohm shunted by 4.5 μ H; 2 ohms shunted by 4.5 μ H without a 50-ohm termination.

VSWR is less than 1.2 at 1.5 GHz.

VOLTAGE RATING at 0 V DC is 25 V RMS, 1 kV pulse peak. The volts-second product is 100 V- μ s. If exceeded, the L/R decay will decay rapidly toward zero.

Order 017-0061-00

Please refer to Terms and Shipment, General Information page.

ACCESSORIES WITH N CONNECTORS

50-OHM ATTENUATORS

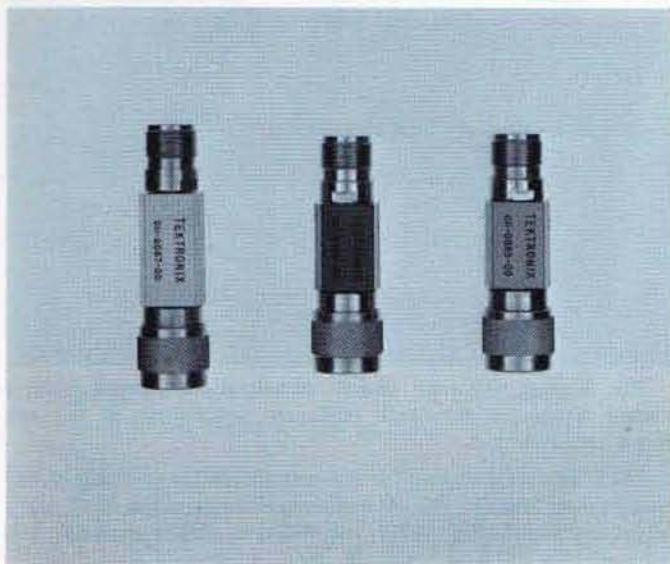

Frequency range is DC to 12.4 GHz. Power rating is 2 W average, 2 kW peak. Impedance is 50 Ω .

DESCRIPTION	PART NUMBER
10-dB attenuator	011-0085-00
20-dB attenuator	011-0086-00
40-dB attenuator	011-0087-00

ADAPTERS



N Male to BNC Female	103-0045-00
N Male to UHF Female	103-0044-00
N Male to GR	017-0021-00
N Female to BNC Male	103-0058-00
N Female to UHF Male	103-0059-00
N Female to GR	017-0062-00

50-OHM CABLE



Coaxial Type N connectors, 6 feet, order 012-0114-00

PATCH CORDS

PATCH CORDS

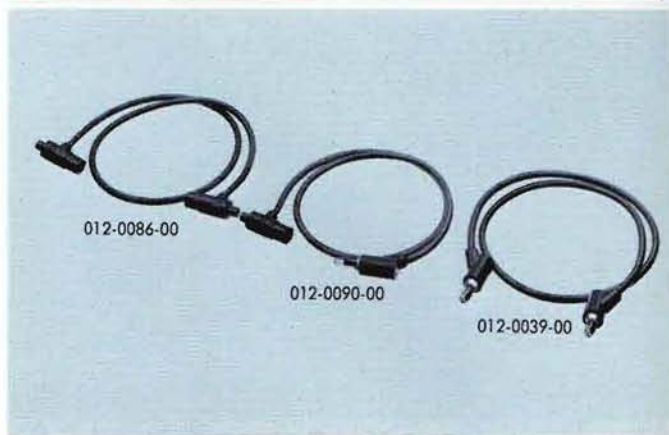

BNC to BNC, 18 in	Red, order 012-0087-00	Black, order 012-0086-00
BNC to banana plug-jack, 18 in	Red, order 012-0091-00	Black, order 012-0090-00
Banana plug-jack to banana plug-jack, 18 in	Red, order 012-0031-00	Black, order 012-0039-00

Please refer to Terms and Shipment, General Information page.

TELEVISION ACCESSORIES

TV SYNC SEPARATOR

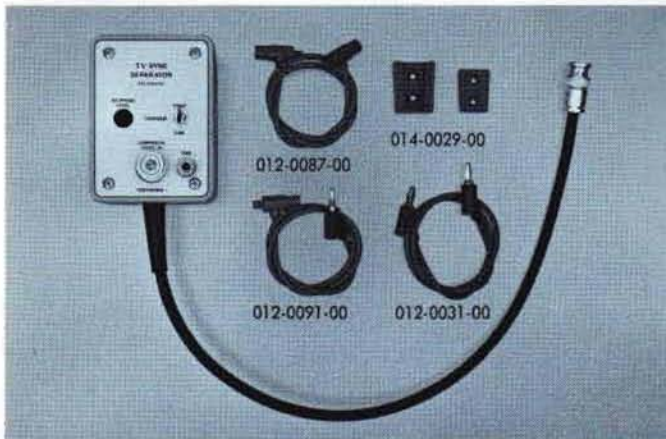

The TV Sync Separator provides the trigger facilities for viewing composite video signals on a conventional oscilloscope. It can be used with Tektronix general-purpose oscilloscopes that have a 100-volt calibrator output. When used with other instruments, a separate 100-V source is required to power the unit.

A front panel switch selects field- or line-rate triggers, and a separate output jack supplies field triggers continuously. The unit has a clipping level control, allowing it to be used with signals ranging from 0.5V to 8.5V in amplitude.

POWER REQUIREMENTS—7 mA; operates on 100-V DC, or from the output of an oscilloscope calibrator with a frequency near 1 kHz.

INPUT—Composite video signal from signal source or from Vert Sig Out jack on front panel of oscilloscope.

OUTPUT— ≈ 10 -V negative-going composite sync for line rate triggering or ≈ 6 -V negative-going field-rate triggers. Selected by toggle switch. Also second output for field-rate triggers.

TV SYNC SEPARATOR, order 015-0062-00

Instrument includes: two patch cords, 18 inch red BNC to banana plug (012-0091-00); two patch cords, 18 inch red BNC to BNC (012-0087-00); patch cord, 18 inch red banana plug to banana plug (012-0031-00); hanger assembly (014-0029-00); instruction manual (070-0542-00).

VIDEO STAIRCASE DIFFERENTIATOR



The Video Staircase Differentiator permits the use of a general-purpose oscilloscope for measuring amplitude linearity in TV systems.

The staircase differentiator is a filter which differentiates the steps of an unmodulated, linearity staircase (VIT signal) into spikes. The spikes appear on a common-reference level. Amplitude linearity is checked by comparing the amplitude of the spikes on the oscilloscope display. The generator used must supply a staircase having equal risetime, for the output amplitude of the differentiator is proportional to the rate of rise. Input impedance of the differentiator is 75 ohms.

VIDEO STAIRCASE DIFFERENTIATOR, order 015-0075-00

Please refer to Terms and Shipment, General Information Page

OPERATIONAL AMPLIFIER ADAPTERS

LOGARITHMIC AMPLIFIER ADAPTER

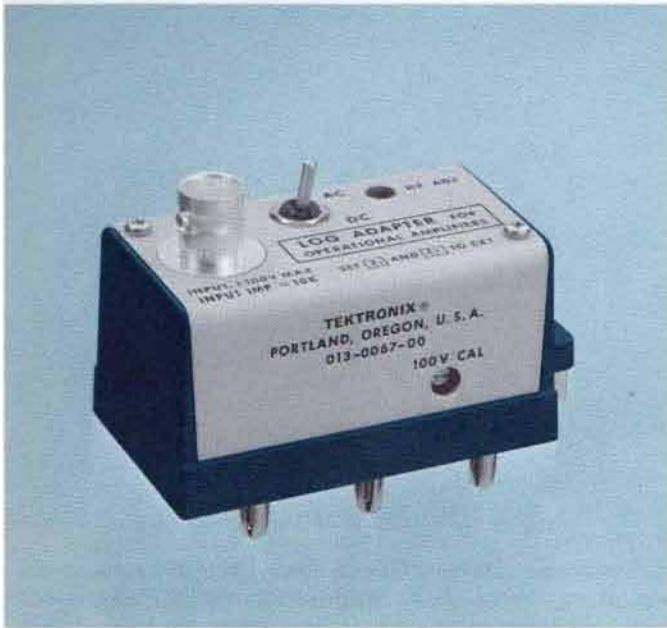

The Logarithmic Amplifier Adapter converts linear amplification characteristics of either operational amplifier in the Type O or 3A8 Plug-In Unit to approximate logarithmic characteristics.

ALLOWABLE INPUT SIGNAL— ± 100 V maximum, AC or DC-coupled.

INPUT IMPEDANCE—Approximately 10 kilohms.

AMPLIFICATION CHARACTERISTICS—With the Logarithmic Amplifier Adapter, the operational amplifier approximates a logarithmic amplification response for input signals from ± 0.1 V to ± 100 V.

Signal-In	Deflection	Signal-In	Deflection
± 0.1 V	1 cm ± 0.5 mm	± 10.0 V	3 cm ± 1.0 mm
± 1.0 V	2 cm ± 0.5 mm	± 100 V	4 cm ± 1.0 mm

Below an input level of ± 0.05 V, the amplifier is no longer logarithmic.

RISETIME—Typically $0.2 \mu\text{s}$ —for a 10-V signal to rise from 0.1 V to 10 V.

FALLTIME—Typically $0.3 \mu\text{s}$ —for a 10-V signal to fall from 10 V to 0.1 V.

LOW FREQUENCY RESPONSE—65 Hz. (In the AC-coupled mode, the -3 dB point for signals of over 500 mV peak amplitude, and where the effective input resistance is 10 k.)

BANDWIDTH—The -3 dB apparent bandwidth varies with both signal amplitude and signal DC level. It varies typically from 400 kHz to 1 MHz, depending on the input signal.

LOGARITHMIC AMPLIFIER ADAPTER, order 013-0067-00

LEAKAGE CURRENT ADAPTER



The Leakage Current Adapter, used with Tektronix Operational Amplifier Plug-In Units, adapts the plug-in for measuring the reverse leakage current of semiconductor diodes and small-signal transistors. The adapter may also be used for measuring junction resistance or capacitance.

Banana plugs on the base of the adapter allow the unit to be plugged into the jacks on the front panel of the Plug-In Unit. Axial-lead diodes are checked by placing them in a notched retainer mounted on a swing-down cover. When closed, the cover places the leads against spring-contact clips, assuring good electrical contact. A four-pin socket is provided for checking small-signal transistors. The diode clips and the transistor socket are completely shielded to minimize leakage capacitance.

A positive-going sawtooth voltage is required for driving the adapter. Tektronix Oscilloscopes that accept the Type O Plug-In Unit have a sawtooth or sweep out jack conveniently located on the front panel for supplying the required sawtooth voltage. The Type 3A8 requires an external source of the required sawtooth voltage.

VERTICAL DEFLECTION FACTOR—1 microampere/volt or 1 nanoampere/volt, selected by a toggle switch.

VERTICAL DEFLECTION ACCURACY— $\pm 8\%$.

HORIZONTAL DEFLECTION FACTOR—(with 100-V sawtooth, minimum). 1, 2, 5 and 10-V/cm selected by Horizontal V/CM switch.

HORIZONTAL DEFLECTION ACCURACY— $\pm 3\%$.

INPUT SAWTOOTH VOLTAGE—100 to 200 V (for 10-V/cm horizontal deflection).

MAXIMUM INTERNAL LEAKAGE—50 picoamperes at 100 V.
LEAKAGE CURRENT ADAPTER, order 013-0086-00

Please refer to Terms and Shipment, General Information page.

OPERATIONAL AMPLIFIER ADAPTERS

COMPENSATING ADAPTER

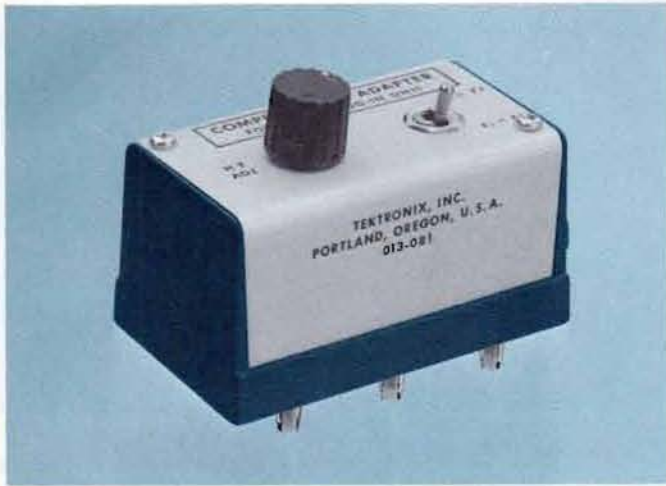

The Compensating Adapter extends the frequency performance of the Plug-In Unit Operational Amplifiers.

The adapter compensates for stray capacitance associated with the internal Z_i and Z_f resistors, providing an adjustment for optimum HF response.

CHARACTERISTICS

PLUG-IN AND ADAPTER

TYPICAL FREQUENCY RESPONSE— ≥ 750 kHz (at 10X gain).

INPUT RESISTANCE—0.01 to 1 megohm, determined by Z_i Selector position.

INPUT CAPACITANCE—approximately 40 to 450 pF, depending on the Z_f Selector position. (Maximum at X100 gain)

MAXIMUM INPUT VOLTAGE—400 V DC or 150 V RMS.*

MAXIMUM OUTPUT VOLTAGE— ± 50 V peak.

MAXIMUM TEMPERATURE— $+55^\circ$ C.

COMPENSATING ADAPTER, order 013-0081-00

*Voltage derating is necessary for frequencies above 1 MHz.

TERMINAL ADAPTER



TERMINAL ADAPTER ASSEMBLY has all the mechanical parts for creating a custom adapter for the Operational Plug-In Unit.

Order 013-0048-01

GATING ADAPTER

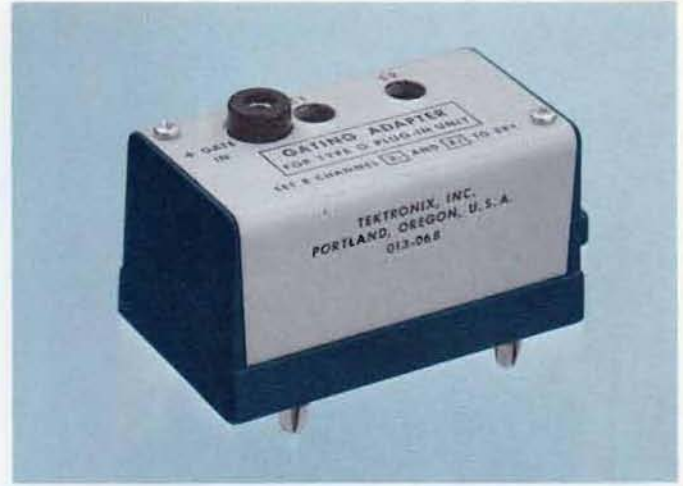

The Gating Adapter permits on and off gating of the Type O Unit from the +20 V gate output of the oscilloscope used. The Adapter can also be used with the Type 3A8 using an external gating signal.

With the Adapter plugged into the lower operational amplifier, the upper operational amplifier is gated on or off. The signal applied is then amplified, integrated or differentiated only during the "on" time.

The Adapter is particularly useful for integration operations where the accumulative voltage of repetitive signals would exceed the voltage rating of the deflection amplifier input.

GATING ADAPTER, order 013-0068-00

TERMINAL SHIELD

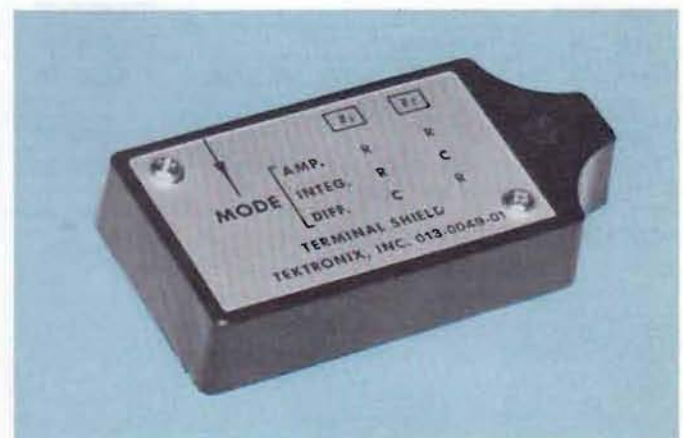

TERMINAL SHIELD protects exposed terminals of the Plug-In Unit from spurious signals.

Order 013-0049-01

Please refer to Terms and Shipment, General Information page.

INSTRUMENT COVERS, CASES

OSCILLOSCOPE DUST COVERS



The dust cover provides protection for the oscilloscope during transport or storage. Made of water-proof blue vinyl, the covers are available for both laboratory and portable instruments. The laboratory version features a clear frontal area for easy identification of the instrument. The portable cover has a pocket for carrying the manual.

INSTRUMENT	PART NUMBER
Type 422 (with battery pack)	016-0075-00
Type 422 (without battery pack)	016-0076-00
Type 453, 454, 491	016-0074-01
Type 502A	016-0070-00
Type 529 (with field case)	016-0085-00
Type 503, 504, 515A, 516, 647A; 560-Series (except Type 565, 567, 568)	016-0067-00
Type 565, 567, 568	016-0069-00
Type 661; 530-, 540-, 550-, and 580-Series (except Type 555 and 556)	016-0068-00

OSCILLOSCOPE DUST COVER

CARRYING CASES



CARRYING CASE—For Type 321A Portable Oscilloscope. Order 016-0026-00



CARRYING CASE—For Type 310A Oscilloscope. Made of sturdy, turquoise-colored canvas. Order 016-0028-01



CARRYING CASE FOR LETTER-SERIES OR 1-SERIES PLUG-IN UNITS—Provides protection for one oscilloscope plug-in unit. Order 437-0065-00

Please refer to Terms and Shipment, General Information page.

INSTRUMENT COVERS, CASES

CARRYING CASES

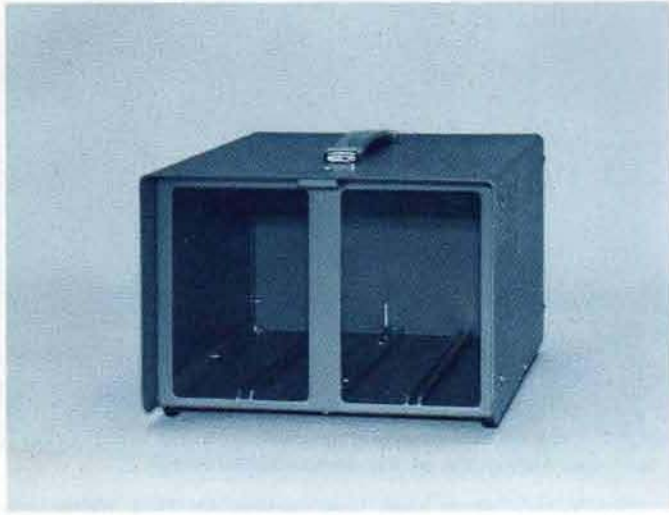

CARRYING CASE FOR 2, 3, 10 and 11 SERIES PLUG-IN UNITS—accommodates two plug-in units.
Order 437-0070-00

CAMERA CARRYING CASES



C-12/C-27 CARRYING CASE—C-12/C-27 Camera Carrying Case holds either the C-12 or C-27 Camera and all the standard accessories plus extra film. The case is constructed of heavy-gauge, high-impact plastic and has a foam-rubber liner. Dimensions are 20½ by 20 by 8 inches. Net weight is 18¼ pounds; domestic shipping weight is ≈22 pounds.

Order 016-0208-01

CAMERA CARRYING CASES



C-30 CARRYING CASE—The C-30 carrying case holds the C-30 Camera, all standard accessories and extra film. The case is constructed of heavy-gauge, high-impact plastic, has foam-backed, vacuum-formed styrene liner. Dimensions are 6⁷/₈ x 11⁵/₁₆ x 14⁷/₁₆ inches. Net weight is 2³/₄ pounds; domestic shipping weight is ≈5 pounds.

Order 016-0092-00

Please refer to Terms and Shipment, General Information page.

MOUNTING ACCESSORIES

CRADLE MOUNTS

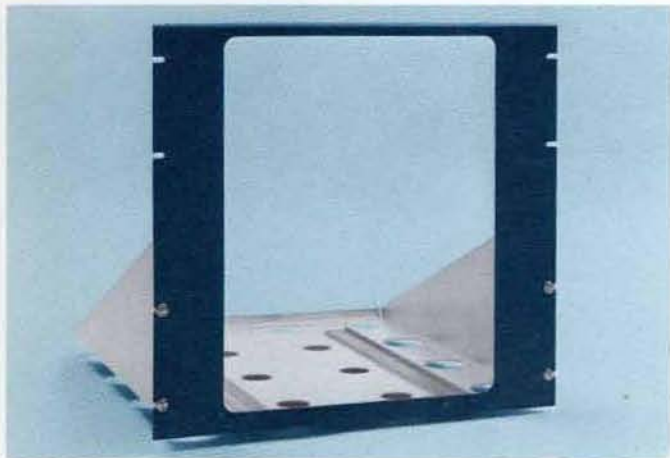

CRADLE-MOUNT—For rack mounting cabinet-type oscilloscopes. Each cradle-mount consists of a cradle (or "shelf") to support the instrument in any standard 19 inch relay rack, and a mask to fit over the regular instrument panel. Blue vinyl finish.

For Type 530- and 540-Series, Type 575 and Type 661 (1 mask, 1 cradle). Rack height requirements 17½ inches. Depth is 21⅞ inches.

Order 040-0281-00

For Type 551 Oscilloscope (2 masks, 2 cradles). Rack height requirements: Indicator mask 17½ inches, Power Supply mask 12¼ inches. Depth is 21⅞ inches.

Order 040-0279-00

For Type 515A and Type 516 instruments (1 mask, 1 cradle). Rack height requirements 15¾ inches. Depth is 21⅞ inches.

Order 040-0277-00

For Type 502A instruments (1 mask, 1 cradle). Rack height requirements 17½ inches. Depth is 21⅞ inches.

Order 040-0278-00

For Type 555 (2 masks, 2 cradles). Rack height requirements: Indicator mask 21 inches, Power Supply mask 12¼ inches. Depth is 21⅞ inches.

Order 040-0280-00

For Types 503, 504, 561A, 564 instruments (1 mask, 1 cradle). Rack height requirements 15¾ inches. Depth is 21⅞ inches.

Order 040-0321-01

MOUNTING FRAME—Holds four of any combination of Type FM122, Type 360, or Type 160-Series units. Mounts to standard 19 inch instrument rack.

Order 014-0002-00

BLANK PANEL—Covers space normally occupied by one instrument mounted in the frame.

Order 333-0157-00

REAR-SUPPORT CRADLES

CRADLE-ASSEMBLY—Provides rear support for rack-mount instruments with slide-out tracks, when mounted in a 19-inch backless rack.

For Types RM15, RM561A, RM564, RM647A, and Type 127.

Order 040-0344-00

For Types RM565 and RM567.

Order 040-0346-00

RACK ADAPTER



The Rack Adapter converts the latest series of Tektronix Generators for rack mounting. The rack adapter mounts in a standard 19-inch wide rack and is 5¼ inches high and 17¾ inches deep. Rear mounting brackets can be adjusted for a rear mounting depth of 8½ inches to 26 inches.

Two ½-rack width generators, such as the Type 106 Square-Wave Generator, 114 Pulse Generator, 184 Time-Mark Generator or 191 Constant Amplitude Signal Generator can be mounted side by side. Up to four ¼-rack width generators, such as the Type 284 Pulse Generator can be mounted in one rack adapter. Two ¼-rack width instruments may be mounted with a ½-rack instrument.

The Adapter provides forced-air ventilation and shielding between compartments. Blank panels are available to cover the unused openings when the adapter is not filled. A divider kit is required for each Type 284 installed. A special power cord is required for each instrument installed. Blank panels, divider kits, and special power cords are not included with the Rack Adapter.

RACK ADAPTER, order 016-0086-01

½-WIDTH BLANK PANEL, order 016-0081-00

¼-WIDTH BLANK PANEL, order 016-0109-00

DIVIDER KIT, order 016-0089-00

SPECIAL POWER CORD, order 161-0031-00

Please refer to Terms and Shipment, General Information page.

MOUNTING ACCESSORIES

STORAGE CABINETS

PLUG-IN PREAMPLIFIER STORAGE CABINET mounts in standard 19-inch rack, available in two types:



FOR 1-SERIES AND LETTER-SERIES PLUG-IN UNITS—holds 3 plug-in units. Measures 19 inches wide, 8 $\frac{3}{4}$ inches high, 9 $\frac{3}{8}$ inches deep.

Order 437-0031-00

FOR 2 AND 3-SERIES PLUG-IN UNITS—holds 4 plug-in units. Measures 19 inches wide, 7 inches high, 13 $\frac{5}{16}$ inches deep.

Order 437-0071-00

BLANK PLUG-IN CHASSIS

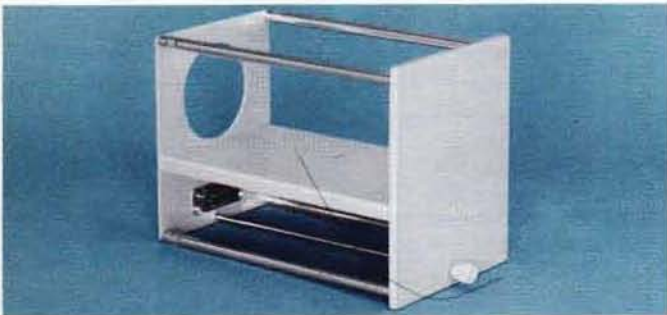

BLANK 1-SERIES AND LETTER-SERIES PLUG-IN CHASSIS—Useful for constructing your own special circuits.

Order 040-0065-00



BLANK TYPE 560-SERIES PLUG-IN CHASSIS—For special circuit construction of sweep or vertical amplifier.

Order 040-0245-00

CAMERA MOUNTING ADAPTERS



Bezels for mounting commercially available cameras on Tektronix Oscilloscopes. Mounting ring measures 5 $\frac{5}{8}$ inches outside diameter. Die-cast construction.

INSTRUMENT*	PART NUMBER
Type 502A, 503, 504, 515A, 516, 530-, 540-, 550-, 580-Series, 565, 661	014-0018-00
Type 561A, 564, 567, 568	014-0016-00
Type 647A	014-0017-00
Type 529	014-0031-00

*Also rackmount version.

Please refer to Terms and Shipment, General Information page.

VIEWING ACCESSORIES

VIEWING ACCESSORIES

The viewing accessories listed normally mount on the oscilloscope graticule cover. In many cases, they will also fit camera-mounting bezels. If you intend using a camera on your oscilloscope, check with your Tektronix Field Engineer for bezel-viewer compatibility before ordering.



POLARIZED VIEWERS—For Tektronix 5-inch Oscilloscopes. The viewers reduce troublesome reflections and glare under high ambient-light conditions.

RECTANGULAR VIEWER, order 016-0039-00

PLASTIC ROUND VIEWER, order 016-0053-00



VIEWING HOOD—For Tektronix 5-inch Oscilloscopes. Includes molded rubber eyepiece and separate tubular light shield. Order 016-0001-01

VIEWING HOOD—For Tektronix 3-inch Oscilloscopes. Includes molded rubber eyepiece and separate tubular light shield. Order 016-0002-00

COLLAPSIBLE VIEWING HOOD—For Tektronix 3-inch Oscilloscopes. It is made of black acrylic plastic with handy fastening arrangement.

Order 016-0010-00



COLLAPSIBLE VIEWING HOOD—For portable instruments with rectangular CRT's. Blue-vinyl material, folds flat for convenient storage.

For Types 422, 491, order 016-0082-00

For Type 453, 454, order 016-0083-00

For Types 561A, 564, 567, 568, order 016-0103-00

CRT MESH FILTERS

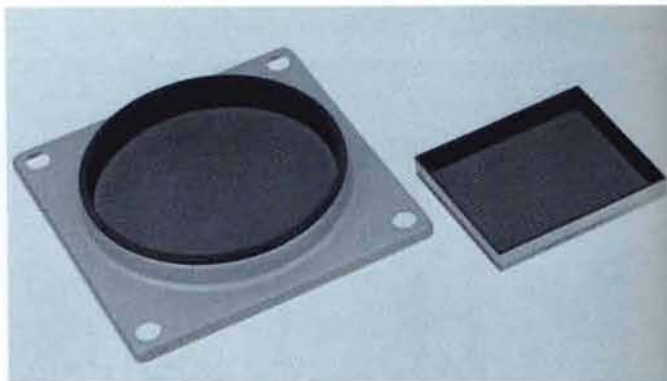

The mesh filter improves display contrast for oscilloscope viewing under high-ambient light conditions. The filter is a direct replacement for the existing graticule cover on most Tektronix instruments, or, in the case of the new portable oscilloscopes, snaps in the CRT opening on the front panel.

A fine metal screen with a matte black surface is utilized to reduce light reflections. Although light transmission from the CRT is reduced to approximately 28%, the high attenuation of external reflections allows viewing low-intensity displays in room light or other bright surroundings.

The mesh filter also serves as an RFI filter. Installed on the instrument, the metal frame of the filter is grounded, providing effective filtering of the RFI spectrum.

INSTRUMENT*	PART NUMBER	
Type 321A	378-0577-00	
Type 422, 491	378-0571-00	
Type 453, 454	378-0573-00	
Type 502A, 503, 504, 515A, 516, 661, 530, 540, 550, 580-Series, 565	378-0572-00	
Type 529, 561A, 564, 567, 568	378-0575-00	
Type 647A	378-0574-00	

*For both cabinet and rack-mount instruments.

Please refer to Terms and Shipment, General Information page.

VIEWING ACCESSORIES

CATHODE-RAY TUBE LIGHT FILTERS

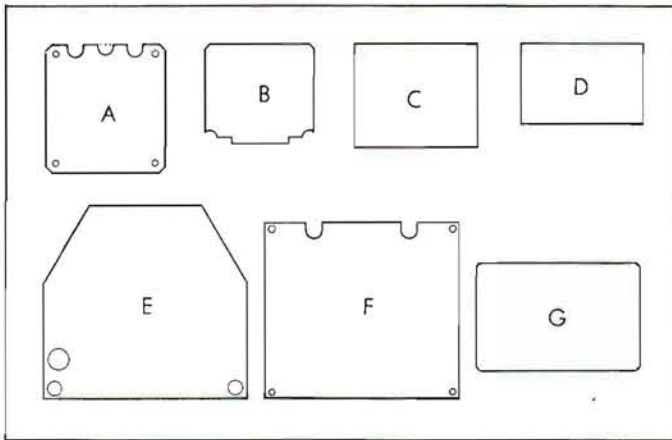

INSTRUMENT*	FIG	COLOR	PART NUMBER
Type 310A, 317, RM17, 360	A	Smoke gray† Green Blue Amber	378-0550-00 378-0551-00 378-0552-00 378-0553-00
Type 321A	B	Smoke gray† Green Blue Amber	378-0547-00 378-0554-00 378-0555-00 378-0556-00
Type 422, 491	C	Smoke gray† Green Blue Amber	378-0549-00 378-0557-00 378-0558-00 378-0559-00
Type 453, 454	D	Smoke gray† Green Blue Amber	378-0576-00 378-0576-03 378-0576-02 378-0576-01
Type 502A, 503, 504, 515A, 516, 530-, 540-, 550-Series, 565, 580-Series, 661	E	Smoke gray† Green Blue Amber	378-0567-00 378-0568-00 378-0569-00 378-0570-00
Type 529, 561A, 567, 568	F	Smoke gray† Green Blue Amber	378-0560-00 378-0561-00 378-0562-00 378-0563-00
Type 647A	G	Smoke gray† Green Blue Amber	378-0548-00 378-0564-00 378-0565-00 378-0566-00

*For both cabinet and rack-mount instruments unless rack-mount version is listed.

†Standard filter supplied with instrument.

UNSCRIBED GRATICULES

INSTRUMENT*	PART NUMBER
310A, 317, 360	386-0395-00
536, 551, 555, 575	331-0093-00
502A, 503, 504, 515A, 516, 661	331-0105-00
549	386-0451-00
531A, 533A, 535A	386-0451-00 (adjustable)
	331-0093-00 (not adjustable)

*For both cabinet and rack-mount instruments.

Please refer to Terms and Shipment, General Information page.

INSTRUMENT INDEX

TYPE	INSTRUMENT DESCRIPTION	PAGE	TYPE	INSTRUMENT DESCRIPTION	PAGE
B	DC-to-20 MHz Unit	120	114	Pulse Generator	257
CA	DC-to-24 MHz Dual-Trace Unit	280	R116	Programmable Pulse Generator	258
C-12	Trace-Recording Camera	284	122, FM122,		
C-27	Trace-Recording Camera	286	RM122		
C-30	Trace-Recording Camera	288	125, FM125,	Low-Level Preamplifiers	260
C-40	Trace-Recording Camera	289	RM125		
D	DC Differential Unit	280	127	Power Supplies	261
E	AC Differential Unit	280	129	Plug-In Unit Power Supply	262
G	DC-to-20 MHz Differential Unit	121	130	Plug-In Unit Power Supply	264
H	DC-to-15 MHz Unit	122	132	Direct-Reading L-C Meter	266
K	DC-to-30 MHz Unit	123	133	Plug-In Unit Power Supply	267
L	DC-to-30 MHz Unit	124	160A	Plug-In Unit Power Supply	268
M	DC-to-20 MHz Four-Trace Unit	280	161	Power Supply	269
O	Operational Amplifier Unit	125	162	Pulse Generator	270
Q	Transducer & Strain Gage Unit	127	163	Waveform Generator	271
T	Time-Base Unit	89	175	Pulse Generator	272
W	Differential Comparator Unit	129	184	High-Current Adapter	221
Z	Differential Comparator Unit	280	191	Time-Mark Generator	274
1A1	DC-to-50 MHz Dual-Trace Unit	131	200-205-Series	Constant-Amplitude Signal Generator	275
1A2	DC-to-50 MHz Dual-Trace Unit	133	230, R230	Scope-Mobile® Carts	294
1A4	DC-to-50 MHz Four-Trace Unit	134	262	Digital Unit	204
1A5	DC-to-50 MHz Differential Unit	136	263	Programmer	200
1A6	DC-to-2 MHz Differential Unit	138	281	Programmer	171
1A7A	10 μ V/cm Differential Unit	139	282	Time-Domain Reflectometer Pulsar	276
1L5	50 Hz-to-1 MHz Spectrum Analyzer Unit	142	283, R283	Probe Adapter	276
1L10	1-to-36 MHz Spectrum Analyzer Unit	144	284	Real-Time Adapter	281
1L20	10 MHz to 4.2 GHz Spectrum Analyzer Unit	145	292	Pulse Generator	277
1L30	925 MHz to 10.5 GHz Spectrum Analyzer Unit	146	R293	Semi-Conductor Tester Power Supply	281
1S1	350-ps Sampling Unit	147	310A	Programmable Pulse Generator and Power Supply	278
1S2	90-ps Reflectometer and Sampling Unit	149	317, RM17	DC-to-4 MHz Portable Oscilloscope	23
2A60	DC-to-1 MHz Amplifier Unit	163	321A	DC-to-10 MHz 9 kV Oscilloscopes	25
2A61	10 μ V/div AC Differential Unit	164	360	DC-to-6 MHz Portable Oscilloscope	28
2A63	Differential Amplifier Unit	165	410	Indicator	273
2B67	Time-Base Unit	166	422, R422	Physiological Monitor	31
3A1	DC-to-10 MHz Dual-Trace Unit	281	453, R453	DC-to-15 MHz Portable Oscilloscopes	34
3A2	Dual-Trace Analog/Digital Amplifier Unit	211	454, R454	DC-to-50 MHz Portable Sweep-Delay Oscilloscopes	38
3A3	Dual-Trace Differential Unit	167	491, R491	DC-to-150 MHz Portable Sweep-Delay Oscilloscopes	43
3A5	DC-to-15 MHz Automatic/Programmable Amplifier Unit	169	502A, RM502A	10 MHz-to-40 GHz Spectrum Analyzers	48
3A6	DC-to-10 MHz Dual-Trace Unit	172	503, RM503	100 μ V/cm Dual-Beam Oscilloscopes	52
3A7	Differential Comparator Unit	173	504, RM504	DC-to-450 kHz X-Y Oscilloscopes	55
3A8	Operational Amplifier Unit	174	507	DC-to-450 kHz Oscilloscopes	57
3A72	DC-to-650 kHz Dual-Trace Amplifier Unit	176	515A, RM15	High-Voltage, Surge Test Oscilloscope	281
3A74	DC-to-2 MHz Four-Trace Amplifier Unit	177	516	DC-to-15 MHz Oscilloscopes	59
3A75	DC-to-4 MHz Amplifier Unit	178	519	DC-to-15 MHz Dual-Trace Oscilloscope	62
3B2	Analog/Digital Time-Base Unit	211	520, R520	DC-to-1 GHz Oscilloscope	64
3B3	Time-Base Unit	179	520, R520	NTSC Vectorscope	67
3B4	Time-Base Unit	180	529, RM529	PAL Vectorscope	71
3B5	Automatic/Programmable Time-Base Unit	170	531A, RM31A	Television Waveform Monitors	75
3C66	Carrier Amplifier Unit	181	533A	DC-to-15 MHz Oscilloscopes	80, 280
3L5	50 Hz-to-1 MHz Spectrum Analyzer Unit	183	535A, RM35A	DC-to-15 MHz Oscilloscopes	83
3L10	1-to-36 MHz Spectrum Analyzer Unit	185	536	DC-to-15 MHz Oscilloscopes	86
3S1	350-ps Dual-Trace Sampling Unit	187	543B, RM543B	DC-to-11 MHz X-Y Oscilloscopes	89
3S2	Dual-Trace Sampling Unit	188, 213	544, RM544	DC-to-33 MHz Oscilloscopes	92
S1	350-ps Sampling Head	189, 214	RM544 Mod 720A	DC-to-50 MHz Oscilloscopes	95
S2	50-ps Sampling Head	189, 214	545B, RM545B	High-Speed Oscilloscope	281
3S3	350-ps Sampling-Probe Dual-Trace Unit	190	546, RM546	DC-to-33 MHz Oscilloscopes	98
3T2	Random Sampling Sweep Unit	191	547, RM547	DC-to-50 MHz Oscilloscopes	101
3T4	Programmable Sampling Sweep Unit	192, 216	549	DC-to-50 MHz Oscilloscopes	104
3T77A	Sampling Sweep Unit	193	551	Split-Screen Storage Oscilloscope	108
4S1	350-ps Dual-Trace Sampling Unit	248	555	DC-to-27 MHz Dual-Beam Oscilloscope	113
4S2A	90-ps Dual-Trace Sampling Unit	249	556, R556	DC-to-33 MHz Dual-Beam Oscilloscope	280
4S3	350-ps Sampling-Probe Dual-Trace Unit	250	561A, RM561A	DC-to-50 MHz Dual-Beam Oscilloscopes	116
5T3	Sampling Timing Unit	251	564, RM564	Qcilloscopes	151
6R1A	Digital Unit	198	565, RM565	Storage Oscilloscopes	155
10A1	Differential Unit	240	567, RM567	Dual-Beam Oscilloscopes	160
10A2A	DC-to-100 MHz Dual-Trace Unit	242	568, R568	Readout Oscilloscopes	196
11B1	Time-Base Unit	243	575	Readout Oscilloscopes	202
11B2A	Sweep-Delay Time-Base Unit	244	581A	Transistor-Curve Tracer	217
81A	Plug-In Adapter	228	585A, RM585A	DC-to-80 MHz Oscilloscopes	223
82	Dual-Trace Unit	229	601	DC-to-80 MHz Sweep-Delay Oscilloscopes	225
86	Single-Trace Unit	230	611	5-Inch Storage Display Unit	231
106	Squarewave Generator	253	647A, R647A	11-Inch Storage Display Unit	234
109	Pulse Generator	254	661	DC-to-100 MHz Oscilloscopes	237
111	Pretrigger Pulse Generator	255	1121	90-ps Sampling Oscilloscope	246
113	Delay Cable	256	S-3100	X100 Amplifier	281
				Programmable Measurement System	207

ACCESSORY INDEX

	Page
A	
Accessory Housings	
BNC	322
UHF	323
Adapters	
BNC	322
UHF	323
GR	324
N	326
Probe	321
Probe Grounding	321
Rack	332
Type O, 3A8	328, 329
Air Line, GR	325
Attenuators	
BNC	322
UHF	323
GR	324
N	326
B	
Batteries, Replacement	30, 33, 37
BNC, Accessories with BNC Connectors	322
C	
Cabinets, Plug-In Storage	333
Cables	
BNC	322
UHF	323
GR	324
N	326
Cameras	282-293
Camera Carrying Cases	331
Camera Mounting Adapters	292, 333
Cases, Carrying	330, 331
Chassis, Blank Plug-In	333
Compensating Adapter, Type O, 3A8	329
Cords, Patch	326
Coupling Capacitor, GR	325
Covers, Dust	330
Cradle Mount	332
Current Probes	304-305, 312-315
D	
Differentiator, Video	327
Dust Covers	330
F	
Filters	
Light	335
Mesh	334
Frame, Mounting	332
G	
Gating Adapter, Type O, 3A8	329
Graticules, Unscribed	335
Ground Leads, Probe	321
Grounding Adapter, Probe	321
GR, Accessories with GR Connectors	324, 325
H	
High Voltage Probes	302, 303
Hoods, Viewing	334
Housing, Accessory	
BNC	322
UHF	323

I	
Identification Tags, Probe	321
Input Adapters, Cables	
BNC	322
UHF	323
GR	324
N	326
L	
Leads, Patch Cords	326
Leakage Current Adapter, Type O, 3A8	328
Light Filters	335
Log Amplifier Adapter, Type O, 3A8	328
M	
Mesh Filters	334
Mounts, Cradle	332
Mounting Adapters, Camera	333
Mounting Frame	332
N	
N, Accessories with N Connectors	326
O	
Operational Amplifier Adapters	328, 329
P	
Probes	
Accessories	321
Current	304-305, 312-315
High Voltage	302, 303
Reference Chart	296, 297
Voltage	298-303, 306-311, 316-320
Patch Cords	326
Pickoff "T" Voltage	325
Plug-In Chassis	333
Polarized Viewers	334
Power Divider, GR	325
R	
Rack Adapter	332
S	
Sampling Accessories	324, 325
Sampling Probe	311
Probe Reference Chart	296-297
Signal Pickoff, CT-3	325
Shield, Type O, 3A8 Terminal	329
Storage Cabinets, Plug-In	333
Sync Separator, TV	327
T	
Tags, Probe Identification	321
Television Accessories	327
Terminations	
BNC	322
UHF	323
GR	324
Terminal Adapters, Type O, 3A8	329
Terminal Shields, Type O, 3A8	329
Tips, Probe	321
TV Sync Separator	327
U	
Unscribed Graticules	335
UHF, Accessories with UHF Connectors	323
V	
Video Differentiator	327
Viewing Accessories	334
Viewers, Polarized	334
Voltage Pickoff "T"	325



NEW INSTRUMENTS

TYPE		PAGE
1A7A	High-Gain Differential Unit	139
3S1	350-ps Dual-Trace Sampling Unit	187
3S2	Dual-Trace Sampling Unit	188, 213
S1	350-ps Sampling Head	189, 214
S2	50-ps Sampling Head	189, 214
81A	Plug-In Unit Adapter	228
284	Pulse Generator	277
410	Physiological Monitor	31
520	NTSC Vectorscope	67
520	PAL Vectorscope	71
601	Storage Display Unit	231
611	Storage Display Unit	234
P6042	DC-to-50 MHz Current Probe	314
P6046	DC-to-100 MHz Differential Probe and Amplifier	318
S3100	Programmable Measurement System	207

T
E
K
T
R
O
N
I
X.[®]